

# MARKET OPTIMIZATION

Version 62

Last Revised: April 9, 2024

## Revision History

Version	PRR	Date	Description
62	1552	4/9/2024	PRR 1552 Clarification on Number of Historical Days Used in the Mosaic Quantile Regression
61	1473	10/4/2022	PRR 1473 Flexible Ramp Product(FRP) Deliverability
60	1403	5/27/2022	PRR 1403 Treatment of expected energy for non-participating energy imbalance market resources
59	1396	1/25/2022	PRR 1396 Adding a special rule to section C.2.1.24 when a BA SE schedule is submitted below PMIN and above zero for purposes of submitting startup energy. Effective Date:11/1/2021
58	1269	10/12/2020	PRR 1269 With the upgrade of the ADS platform, few enhancements that provide both operational and market efficiencies were added.  Correction to section C.2.1.18 and C.2.1.22 based on PRR1176.  Deleting the defined term "Participating Intermittent Resource Export Fee" per Docket No. ER19-1837-000
57	1235	05/28/2020	This is an update to the listing of expected energy types to include some manual dispatch codes.
56	1220	03/26/2020	PRR1220 The changes are related to the scenario when calculating real-time bid costs associated with decremental energy from the day-ahead configuration where the day-ahead configuration was outaged or de-rated in real-time. In this scenario, the resource is not entitled to bid cost recovery. Instead, this energy will be charged at the LMP.
55	1176	10/28/2019	PRR1176 Changes to the expected energy calculation due to the new hourly and 15-minute block dispatchable PDRs from ESDER3A project.
54	1171	09/26/2019	PRR1171 Added a footnote to clarify the Load Conformance Limiter logic in the Fifteen-minute market.
53	-	05/02/2019	Miscellaneous updates due to outdated language related to OMAR system.
52	1116, 1128	02/27/2019	PRR1116 Added a new Attachment M to detail the functionality of the imbalance conformance and the conformance limiter based on the related policy and Tariff filing.  PRR1128 Added new table in section K.1 for reason code mapping.

51	1087, 1109	11/29/2018	PRR1087 GCA RM addition PRR1109 Transferring Attachment F to Congestion Revenue Rights BPM Attachment I.
50	1071	10/30/2018	VER DOT updates in section A.12.1. This is a clarification for the tariff filing that provides details regarding when and how eligible intermittent resources should respond to dispatch or operating instructions. Effective upon acceptance of FERC filing. ***RE-instating changes due to PRRs 906 & 907 since these changes were mistakenly dropped out during a version 46 update.
49	1052	05-24-2018	Updating the documented process of addressing market issues.
48	1048	04-24-2018	Updated the Dynamic Competitive Path Assessment (DCPA) in section B.1.2 & B.1.3
47	972	04-07-2017	Modifications to the congestion revenue rights settlement rule based on the Tariff amendment submitted on May 27, 2017.
46	918	09-01-2016	This revision is related to BCR-VER project and its impact to expected energy calculation. Also included miscellaneous corrections.

## Table of Contents

<b>A. Market Interfaces</b> .....	<b>9</b>
A.1 Scheduling Infrastructure & Business Rules (SIBR) System.....	9
A.2 Automated Demand Forecasting System (ALFS).....	9

---

A.2.1	Integrated Forward Market (Full Network Model)	9
A.2.2	RMR Preschedule	10
A.2.3	LMP Load Zones	10
A.2.4	ALFS Loss of Data Interfaces	10
A.3	Master File	10
A.4	Open Access Same Time Information System (OASIS)	11
A.5	Settlements & Market Clearing System (SaMC)	11
A.6	Energy Management System (EMS)	12
A.6.1	EMS Loss of Data Interfaces	12
A.6.2	State Estimator Failure	12
A.7	Automated Dispatch System (ADS)	13
A.7.1	ADS Loss of Data Interfaces	13
A.8	Control Area Scheduler (CAS)	14
A.8.1	CAS Loss of Data Interfaces	14
A.9	CAISO Market Results Interface (CMRI)	14
A.10	Market Results Interface - Settlements (MRIS) Application	14
A.11	Electronic Tagging System	14
A.12	Participating Intermittent Resource Program (PIRP) and Eligible Intermittent Resources (EIRs)	15
A.12.1	EIR Self-Schedules, Economic Bids, and Dispatch	15
A.12.2	Scheduling Coordinator Self Certification to Provide a Power Forecast	17
A.13	Wind Generator Forecasting and Communication Equipment Requirements	17
A.14	Solar Generator Forecasting and Communication Equipment Requirements	19
A.14.5	Forced Outage Reporting	20
A.16	Forecast Fee	21
A.17	Wind and Solar EIR Short Term Forecasting	21
A.18	Missing Scheduling Coordinator Forecasts	22
<b>B.</b>	<b>Competitive Path Assessment</b>	<b>24</b>
B.1	Dynamic Competitive Path Assessment (DCPA)	24
B.1.1	Accounting For Resource Control	24
B.1.2	Process Flow for the Dynamic Competitive Path Assessment (DCPA) In the Day Ahead and Real Time Market:	26
B.2	Default Competitive Path Assessment list	29

	<b>C. Expected Energy Calculation</b> .....	<b>32</b>
	C.1 Expected Energy Definition.....	32
	C.2 Expected Energy Calculation .....	39
	C.2.1 Top-level Algorithm.....	40
	C.3 Ex Post Capacity Allocation .....	170
	C.3.1 Online Resource not on Load Following or Regulation.....	173
	C.3.2 Online Resource not on Load Following, but on Regulation .....	174
	C.3.3 Online Resource on Load Following, Not on Regulation .....	176
	C.3.4 Online Resource on Load Following & Regulation .....	178
	C.4 Expected Energy Allocation .....	180
	C.4.1 Expected Energy Types and Market Service Types .....	181
	C.4.2 Allocation Logic .....	187
	C.5 Market Data Correction.....	193
	C.6 Publish Expected Energy Calculation .....	193
	C.7 Multi-Stage Generating Resource Expected Energy .....	193
Resources	C.7.1 Real-Time Minimum Load Energy Calculation for Multi-Stage Generating 193	
	C.7.2 Real-Time Economic Dispatch Levels for Multi-Stage Generating Resources	198
	C.7.3 Residual Imbalance Energy for Multi-Stage Generating Resources .....	200
	<b>D. Commitment Cost Determination</b> .....	<b>204</b>
	D.1 Introduction .....	204
	D.2 General Principles of Self Commitment Determination.....	205
	D.2.1 Minimum Up Time (MUT) Examples.....	207
	D.2.2 Minimum Down Time (MDT) Examples .....	208
	D.2.3 Maximum Daily Start-Ups (MDS) Examples .....	209
	D.3 <b>CAISO/Self-Commitment Extension in ELC – Examples</b> .....	211
	D.3.1 Minimum Up-Time (MUT) Examples .....	212
	D.3.2 Minimum Down Time (MDT) Examples .....	214
	D.4 <b>CAISO/Self-Commitment Extension in IFM - Examples</b> .....	218
	D.4.1 Minimum Up-Time (MUT) Examples .....	218
	D.5 <b>Pump Storage Resources and Participating Loads</b> .....	221
	D.6 <b>Real-time Self Commitment Type determination</b> .....	223
	D.6.1 Introduction .....	223

---

D.6.2	RTM Self-Commitment Type Determination for Generator Resources .....	227
D.6.3.	RTM Commitment Type Determination for Pump Storage Generator Resources in Pumping Mode.....	236
D.7.	IFM/RUC/RTM Start-up Cost/Pump Shut-down Cost and Minimum Load Cos/Pumping Cost Determination.....	254
D.7.1	Data Requirements.....	255
D.7.2	Some Background Information.....	256
D.7.3	Business Rules for Cost Calculation.....	259
D.7.4	Business Rules for Cost Calculation for Multi-Stage Generating Resources.....	265
D.7.5	Business Rules Change for Convergence Bidding.....	270
<b>E.</b>	<b>Price Corrections Make Whole Payments.....</b>	<b>272</b>
E.1	Correction Overview .....	272
E.2	Make Whole Calculation Elements .....	273
<b>G.</b>	<b>Process for Addressing Market Issues.....</b>	<b>280</b>
G.1	Definition Market Issues.....	280
G.2	Managing Market Issues.....	280
G.3	Compliance Issues .....	281
<b>H.</b>	<b>Circular Schedule Rule.....</b>	<b>283</b>
H.1	Overview .....	283
H.2	Circular Schedule Rule .....	284
<b>A.</b>	<b>Calculation of Weekly Mileage Multipliers .....</b>	<b>293</b>
J.1	Introduction .....	293
J.2	System Mileage Multiplier.....	293
J.3	Calculation of resource specific Mileage multipliers .....	294
<b>K.</b>	<b>Exceptional Dispatch.....</b>	<b>297</b>
K.1	Introduction .....	297
K.2	Categories and Applications of Exceptional Dispatch.....	297
K.3	Sections of the CAISO Tariff that address Exceptional Dispatch .....	301
<b>L.</b>	<b>Generator Contingency and Remedial Action Scheme Formulation .....</b>	<b>304</b>
L.1	Notation.....	304
L.2	Simplifying assumptions.....	305
L.3	Mathematical formulation.....	305
L.4	Examples .....	310

---

L.4.1	Secure transmission after remedial action scheme operation.....	310
L.3.1	Secure transmission after generator loss .....	320
<b>M.</b>	<b>Imbalance Conformance .....</b>	<b>329</b>
M.1	Load Forecast Conformance Logic.....	329
M.2	Conformance Limiter.....	330
<b>N.</b>	<b>Calculation of Flexible Ramp Requirements.....</b>	<b>335</b>

# **Attachment A**

## **MARKET INTERFACES**



---

## A. Market Interfaces

This *Market Interfaces* attachment presents the data exchange between Market applications. Refer to Section 3.3, Market Interfaces, which shows the inter-relationships of these applications.

### A.1 Scheduling Infrastructure & Business Rules (SIBR) System

The SIBR system performs the following tasks:

- Provides an SC interface to submit Bids and Inter-SC Trades
- Applies business rules to validate and process submitted Bids and Inter-SC Trades
- Applies business rules to generate DAM Bids for Generating Units under the must offer obligation (Generating Unit adequacy requirement) and Real-Time Market Bids for Generating Units with Day-Ahead AS or RUC Awards, if these Generating Units do not have valid Bids
- Provides SCs with information about their Bid and trade validation and processing
- Forwards the final (clean) Bids and trades to the relevant Market applications and to the SC
- Stores information for auditing purposes

### A.2 Automated Demand Forecasting System (ALFS)

The elements of ALFS are described in this section.

#### A.2.1 Integrated Forward Market (Full Network Model)

Requires Day-Ahead and two Days-Ahead Demand Forecasts, in increments of one hour for the following:

- **Metered Subsystems (MSSs)** – Load forecasts for Load-following MSSs are required. In addition, if the other MSSs do not provide their own Load forecasts, CAISO provides one.
- **Calculated Forecasts** – Presently some IOU forecasts include the MSSs. Once the MSS forecasts become available, the IOU Load forecasts without the MSSs in their area are used. This is accomplished within ALFS, using software from Itron.

- 
- **Other Control Areas** – Load forecasts for some control areas are necessary because their detailed networks are included in the Full Network Model. In order to provide the most accurate forecast, the non-conforming Pumping Load is forecasted separately from the temperature-sensitive conforming Load.
  - **Load forecast** for CFE is desirable, since it is part of the California-Mexico Reliability Coordination Area. IID has recently joined the WECC Desert Reliability Coordination Area and thus is not a likely candidate for Load forecasting.
  - **Congestion Zones** – In IFM, Congestion zones are not needed except for financial trades. However, for Ancillary Services, an additional Load forecast is required.

### A.2.2 RMR Preschedule

Requires Day-Ahead forecasts, in increments of one hour for the following:

- **Local Control Areas (LCAs)** – In order to make the RMR preschedules consistent with the IFM, it is desirable to have the RMR preschedules use the same Load forecasts as IFM. Therefore, forecasts are needed for existing LRAs defined by Operations Engineering. One area Load forecast is currently provided by ALFS. Forecasts for the LRAs may also be used to improve the application of LDFs, since LDFs can be applied to smaller areas.

### A.2.3 LMP Load Zones

Requires Day-Ahead forecasts, in increments of one hour for the following:

- **LMP Load Zones** – At this time, CAISO is not considering LMP for Load forecasting.

### A.2.4 ALFS Loss of Data Interfaces

ALFS updates Load forecasts every 15 minutes. In the event of failure to update data, RTM continues to use the un-updated data. If data does not exist for a particular interval, RTM uses data from the last available interval or from a CAISO Operator enterable data entry point.

RTM alerts the user when ALFS data has not been updated for 30 minutes (configurable parameter). RTM also alerts the user when data does not exist for a particular interval.

## A.3 Master File

The Master File is a general repository of quasi-static data needed to operate and support the CAISO Markets. The Master File contains data that remain unchanged for relatively long periods of time. Relevant Master File data includes:

- 
- SC registration and associated attributes
  - Resource registration, characteristics, Market and product certifications, and associated attributes such as location, SC association, must offer, or RMR status
  - Network node and branch registration and associated attributes
  - Node aggregation definitions (LAPs, Trading Hubs, AS Regions, RUC zones, designated Congestion areas)
  - Transmission interface definitions
  - TOR and ETC registration
  - Market parameters such as Bid caps and MPM thresholds

Although SCs do not interface directly with the Master File, they are obligated to provide accurate data for populating and updating the Master File with their applicable Generating Unit characteristics, such as minimum and maximum capacity, Forbidden Operating Regions, Ramp Rates, Minimum Run and Down Times, average heat rates or average production costs. This requirement is based on Section 4.1.2 of the Pro Forma Participating Generator Agreement (Appendix B.2 of the CAISO Tariff).

Additional information on the Master File is available on the CAISO web site at:

<http://www.caiso.com/docs/2005/10/27/2005102715043129899.html>

## **A.4 Open Access Same Time Information System (OASIS)**

The OASIS provides a Web interface for Market Participants to retrieve public Market information, including:

- Demand forecast
- AS requirements
- Aggregate Schedules
- Transmission interface limits and flows
- Locational Marginal Prices
- Regional Ancillary Services Market Prices

This is described in more detail in Section 13 of the *BPM for Market Instruments*.

## **A.5 Settlements & Market Clearing System (SaMC)**

SaMC receives Market results from the CAISO Markets and meter data from SCs to perform Settlement according to specific business rules and charge types. Refer to the *BPM for Settlements & Billing* for further information.

## A.6 Energy Management System (EMS)

EMS sends control data to units on regulation. It matches electricity Supply and Demand on a four second basis. EMS has an associated database called PI to store the data.

As part of this functionality, EMS gets telemetry and data from the State Estimator, data from most units in the CAISO Control Area, and all of the transmission lines interfacing with other control areas. EMS/PI is the source of this data for the Real-Time processes. EMS is also the source of the base Full Network Model.

EMS receives preferred operating point data, representing the economic Dispatch Instruction, from RTED via the ramp tool. EMS sends this data to units on regulation as a neutral set point. EMS also receives information on dispatched Ancillary Services, which is used to calculate Energy reserves for the power system

### A.6.1 EMS Loss of Data Interfaces

EMS updates data every 30 seconds. In the event of failure to update data for five minutes, RTM considers the data obsolete and alerts the user. RTM performs the following actions in the event of either obsolete or bad quality EMS data (note that data manually replaced in EMS is not considered to be obsolete or of bad quality):

- Marks affected data with a flag on applicable screens
- Does not use affected regulating limits from EMS for Ancillary Services and Supplemental Energy allocation. Instead, uses the limits from the Master File according to the “next hour’s” allocation.
- Does not use affected telemetry for the imbalance MW calculations. Instead, assumes that the Generating Unit attempts to comply with the DOT starting at the last good telemetry point using the Generating Unit’s physical Ramp Rate.

### A.6.2 State Estimator Failure

A State Estimator and a full AC power flow are run in the EMS in order to create the system state that is transferred to the RTM system. This information is transferred from the EMS to the RTM system every 5 minutes and on events that trigger the State Estimator. This data is used to initialize the network model in the RTM system with the current power system state.

The RTM uses the state of the power system and switch status (switch status received in both full and incremental modes) to solve the base case power flow.

---

The RTM uses the most recent SE solution. RTM uses the old solution if a new SE solution (for a user specified number of intervals) has not been received by the RTM system.

A DC power flow solution is used in case the full AC power flow does not solve in the RTM system.

## **A.7 Automated Dispatch System (ADS)**

ADS is an application developed by CAISO to communicate Real-Time Dispatch Instructions to SCs. As a user of ADS, you are able to:

- Receive and generally respond to in-hour Dispatch Instructions in Real-Time
- Receive confirmation of accepted pre-Dispatch Instructions
- Retain a local record of the transaction
- Query a database for historical instructions

SCs are able to accept or decline inter-tie dispatches, or may be able to communicate their ability to respond to the dispatches. SCs can also use ADS to record control area approval of intertie dispatches and to push accepted intertie instructions to CAS.

The public Internet is the method of transmitting the instruction and response information between CAISO and the SC. ADS uses 128-bit domestic encryption and Secure Sockets Layer (SSL) communications technology, combined with medium assurance digital certificates and smart cards, to create a secure environment. Detailed logs are maintained by CAISO to assist in dispute resolution.

### **A.7.1 ADS Loss of Data Interfaces**

In the event of loss of connectivity to ADS, or particular ADS tables, or incorrect flags in interface tables, RTM alerts the user of a problem, indicates what RTM detects as the problem, and allows the user to retry connecting to ADS.

If the user cannot restore the connection before any subsequent dispatches, then a means is provided to continually display the requested Dispatch so that CAISO Operators may manually Dispatch the resources, or remove resources from the list. When CAISO Operators are finished, they indicate such to RTM and then RTM writes the results to the Dispatch log. RTM also records the event in SIBR so that Expected Energy can be recalculated later.

## **A.8 Control Area Scheduler (CAS)**

A detailed description of the interchange transactions and associated tagging is given in Section 6.3.2 for DAM and Section 7.2.2 for RTM.

### **A.8.1 CAS Loss of Data Interfaces**

The CAS updates Schedules every 5 minutes. In the event of loss of data updates, RTM continues to use the un-updated data. If data does not exist for a particular hour, RTM uses data from the last available hour as proxy for following hours.

RTM alerts the user when CAS data has not been updated for 10 minutes (configurable parameter). RTM also alerts the user when no data exists for a particular hour.

## **A.9 CAISO Market Results Interface (CMRI)**

The CAISO Market Results Interface or CMRI is the reporting interface that contains private market information resulting from the CAISO Market Processes: MPM, IFM, RUC, and RTM. This includes schedules and awards, resource specific prices, default and mitigated bids, unit commitments and instructions.

In addition to those mentioned above, post-market or after-the-fact information such as Expected Energy (energy accounting results) and the Conformed Dispatch Notice (commonly known as the “CDN”) can be accessed from the CMRI.

Detailed description of these reports can be found under the BPM Market Instruments Section 11.

## **A.10 Market Results Interface - Settlements (MRIS) Application**

The MRIS application is a Web-based application that allows users to locate and export settlement files, such as bill determinants, invoices and configuration output. Additionally, this web-based application allows users to upload, filter, view and export settlement quality meter data (SQMD).

### **A.11 Electronic Tagging System**

The electric tagging system provides the means by which SCs can enter/change the e-Tag information that is required for the interchange of Power transactions between the CAISO

---

Control Area and other Control Areas. See Section 6.3.2 for e-Tags in the Day-Ahead Market and Section 7.2.2 for e-Tags in the Real-Time Market.

## **A.12 Participating Intermittent Resource Program (PIRP) and Eligible Intermittent Resources (EIRs)**

This section is based on CAISO Tariff Sections 4.6.1.1, 4.8, 9.3.10, Appendix F (Rate Schedules) and Appendix Q (Eligible Intermittent Resources Protocol (EIRP)). All Eligible Intermittent Resources (EIRs) with a Participating Generator Agreement, Net Scheduled PGA, Dynamic Scheduling Agreement for Scheduling Coordinators, or Pseudo-Tie Participating Generator Agreement that, among other things, binds the Eligible Intermittent Resource to comply with the CAISO Tariff; must comply with the EIRP. The EIRP also sets forth additional requirements for those EIRs that voluntarily elect to become Participating Intermittent Resources (PIRs) under the CAISO's Participating Intermittent Resource program (PIRP). EIRs are not required to participate in PIRP. PIRs participating in PIRP as of May 1, 2014 and meeting certain additional requirements, including making an election by June 1, 2014, may qualify for PIRP Protective Measures. A resource that holds QF status may also elect to receive PIRP Protective Measures, if qualified to receive such measures, by June 1, 2014. The QF will be eligible to receive PIRP Protective Measures upon expiration of QF status. Irrespective of when a specific resource begins receiving PIRP Protective Measures, PIRP Protective Measures will expire on the sooner of: (a) April 1, 2017; or (b) expiration of the condition that qualified the resource for receiving PIRP protective measures initially (*i.e.*, the execution of a new or amended contract for services that addresses the Imbalance Energy settlement or the addition of equipment that makes the resource physically able to respond to CAISO Dispatch Instructions).

### **A.12.1 EIR Self-Schedules, Economic Bids, and Dispatch**

Scheduling Coordinators for EIRs must either submit a forecast of output with five-minute granularity that is updated every five minutes, or else use the forecast provided by CAISO's forecast service provider which is also produced at a five-minute granularity and updated every five minutes.

The Scheduling Coordinator may choose to either self-schedule or submit economic bids for an EIR. If an EIR is self-scheduled, the self-schedule for each 15-minute interval in the FMM and for each 5-minute interval in RTD is derived from the forecast values. If economic bids are submitted for an EIR, the economic upper limit will be based on the forecast values.

- 
- After each market run, the Scheduling Coordinator for an EIR receives a Dispatch Instruction for the EIR as defined in section 7.2.3.4 of BPM Market Operation. All EIR Dispatch Instructions will be at or below the EIR's forecasted output. If the EIR Dispatch Operating Target (DOT) is equal to the forecasted output then the EIR can produce as it is capable, as provided in Section 34.13.1 of the Tariff. This condition is indicated by a non-negative SUPP component of the Dispatch Instruction.
  - If the market issues an EIR a Dispatch Operating Target below its forecasted value, the SUPP component of the Dispatch Instruction will be a negative. Consistent with Section 34.13.1 of the Tariff, the EIR must not exceed its Dispatch Operating Target when the SUPP component of the Dispatch Instruction is negative. The CAISO will issue a "FOLLOW DOT" flag in ADS when a resource receives a Dispatch Instruction with a negative SUPP component. Scheduling Coordinators that repeatedly and intentionally deviate from their Dispatch Operating Target may be investigated and referred to FERC for violations of the CAISO tariff. See section 7.8.3.1.3 of the Market Operations BPM for more information about SUPP component of the DOT.
  - The CAISO may issue an Operating Instruction directing an Eligible Intermittent Resource not to exceed its Dispatch Operating Target if necessary to maintain system reliability consistent with Section 7.6 or 7.7 of the CAISO tariff. Operating Instructions are communicated pursuant to NERC Standard COM-002-4. The CAISO will issue written or verbal communications to relevant Scheduling Coordinators when an Operating Instruction directs EIRs not to exceed Dispatch Operating Targets. The CAISO will also issue a "FOLLOW DOT" flag in ADS when an Eligible Intermittent Resource receives an Operating Instruction not to exceed its Dispatch Operating Target. In addition, the CAISO will issue an Operating Instruction flag in the ADS User Interface that identifies if an Operating Instruction is in effect. Failure to follow an Operating Instruction is a violation of the CAISO Rules of Conduct (CAISO Tariff Section 37).

When setting the Operating Instruction flag, the CAISO has the ability to specify one of the following reasons for the instruction:

- "Congestion"
- "System Reliability"
- "Over generation"



ADS shall display start time, end time, Operating Instruction reason and Operating Instruction flag for each of Operating Instruction issued by the CAISO.

Upon ADS receiving the Operating Instruction flag, ADS will provide a message to the UI with the reason for the Operating Instruction. The message will remain until acknowledged by the user. ADS will record the user's acknowledgement and display the acknowledgement on the UI. The acknowledgement will be visible when the first user from the SC organization acknowledges the message.

When the CAISO issues an Operating Instruction to a resource, the market dispatch logic for such resource will use the Automated Load Forecast System (ALFS) forecast instead of the persistence forecast for both RTPD and RTD.

### **A.12.2 Scheduling Coordinator Self Certification to Provide a Power Forecast**

A Scheduling Coordinator that wishes to submit its own forecast for an EIR resource must be able to certify that it will provide a state of the art forecast using one of, or a combination of, an internal meteorological department, an energy forecast service provider, or a defined alternative forecasting method/system.

## **A.13 Wind Generator Forecasting and Communication Equipment Requirements**

The requirements set forth in this Section apply to EIRs powered by wind with a PGA or NS PGA, except as otherwise specified below and whether or not the EIR is certified or seeking certification as a PIR. The detailed requirements for forecasting and communication equipment for wind generators are set forth in Appendix Q of the CAISO Tariff.

### **A.13.1 Physical Site Data**

---

As part of an EIRs obligation to provide data relevant to forecasting Energy from the EIR, each applicable wind EIR or its Scheduling Coordinator (SC) must provide the CAISO with accurate information regarding the physical site location of the EIR as outlined in Appendix Q of the CAISO Tariff.. Meteorological and Production Data

Each wind EIR must install and maintain equipment required by the CAISO to support accurate power generation forecasting and the communication of such forecasts, meteorological data, and other needed data to the CAISO. The requirements for communication of such data to the CAISO are set forth in Appendix Q of the CAISO Tariff.

The objective of this requirement is to ensure a dataset that adequately represents the variability in wind velocity within the plant. Where individual EIRs have circumstances that prohibit them from reasonably satisfying this requirement, the CAISO, the forecast service provider, and the wind-plant owner will formulate a cost-effective distribution of Designated Turbines by mutual agreement that approximates this requirement and adequately measures the variability of the wind velocity within the EIR. EIRs seeking a variance from this requirement should do so in the development of their interconnection agreement or, for those EIRs that have already finalized an interconnection agreement, as part of entering into a Meter Service Agreement.

Wind data collected at the nacelle will not represent the true wind value at a plant site, but instead will represent the apparent wind, which can be correlated to the co-located turbines. This requirement will help ensure: (a) multiple data streams for anemometer information; and (b) accurate representation of the data points to calculate wind energy production at the park.

Wind EIRs with a PGA or NS PGA that are operating or have final regulatory approvals to construct as of the effective date of this section that have wind turbines without nacelle anemometers need not comply with the requirements of this section for Designated Turbines.

An EIR that does not provide the meteorological data required in Appendix Q of the CAISO Tariff will be informed in writing of its failure to provide such required data. Failure to begin providing the required information in the time specified in the written notice will result in the resource participating in the market as a non-EIR resource.

---

### **A.13.2 Training of Neural Network**

High quality<sup>1</sup> production and meteorological data must be collected for a minimum of thirty (30) consecutive days before the ISO can produce a forecast. This data must be collected in advance in order to train the forecast models (e.g., artificial neural networks) responsible for producing the power production (MW) forecast for each site.

### **A.13.3 Maintenance & Calibration**

Meteorological equipment should be tested and, if appropriate, calibrated: (1) in accordance with the manufacturer's recommendations; (2) when there are indications that the data are inaccurate; or (3) when maintenance has been performed that may have interrupted or otherwise adversely impacted the accuracy of the data. The ISO will report in writing to the relevant SC those sites that are sending poor quality meteorological or real time production data. Failure to begin providing adequate data in the time specified in the written notice will result in the resource participating in the market as a non-EIR resource.

## **A.14 Solar Generator Forecasting and Communication Equipment Requirements**

The requirements set forth in this Section apply to solar thermal and solar photovoltaic EIRs with a PGA or NS PGA, except as otherwise specified below and whether or not the EIR is certified or seeking certification as a PIR. The detailed requirements for forecasting and communication equipment for solar thermal and solar photovoltaic generators are set forth in Appendix Q of the CAISO Tariff.

### **A.14.1 Physical Site Data**

As part of an EIR's obligation to provide data relevant to forecasting Energy from the EIR, solar thermal and solar photovoltaic EIRs or their Scheduling Coordinators (SCs) must provide the CAISO with an accurate description of the physical site of the EIR as outlined in Appendix Q of the CAISO Tariff..

---

<sup>1</sup> Data quality must be adequate to produce a state of the art forecast as determined by a forecast service provider. For example temperatures and wind speeds far exceeding local norms or real time MW production with no wind speed or irradiance would be an example of poor data quality.

---

### **A.14.2 Meteorological and Production Data**

Each solar thermal and solar photovoltaic EIR must install and maintain equipment required by the CAISO to support accurate power generation forecasting and the communication of such forecasts, meteorological data, and other needed data to the CAISO. An EIR that does not provide the meteorological data required in Appendix Q of the CAISO Tariff will be informed in writing of its failure to provide such required data. Failure to begin providing the required information in the time specified in the written notice will result in the resource participating in the market as a non-EIR resource.

### **A.14.3 Training of Neural Network**

High quality<sup>2</sup> production and meteorological data must be collected for a minimum of thirty (30) consecutive days before the ISO can produce a forecast. This data must be collected in advance in order to train the forecast models (e.g., artificial neural networks) responsible for producing the power production (MW) forecast for each site.

### **A.14.4 Maintenance & Calibration**

Meteorological equipment should be tested and, if appropriate, calibrated: (1) in accordance with the manufacturer's recommendations; (2) when there are indications that the data are inaccurate; or (3) when maintenance has been performed that may have interrupted or otherwise adversely impacted the accuracy of the data. The ISO will report in writing to the relevant SC those sites that are sending poor quality meteorological or real time production data. Failure to begin providing adequate data in the time specified in the written notice will result in the resource participating in the market as a non-EIR resource.

### **A.14.5 Forced Outage Reporting**

The additional Forced Outage reporting requirements imposed on EIRs under CAISO Tariff Sections 9.3.10.3 and 9.3.10.3.1 are intended to enhance the CAISO's ability to produce accurate forecasts of the EIR output.

---

<sup>2</sup> Data quality must be adequate to produce a state of the art forecast as determined by a forecast service provider. For example temperatures and wind speeds far exceeding local norms or real time MW production with no wind speed or irradiance would be an example of poor data quality.

## A.16 Forecast Fee

Beginning on the date first operational, a EIR with a PGA or QF PGA must pay the Forecast Fee for all metered Energy generated. Notwithstanding the foregoing, the following exemption from the Forecast Fee applies:

- EIRs meeting all of the following criteria: (a) has a Master File PMax of less than 10 MW, (b) it sold Energy under the terms of a PURPA power purchase agreement before operating pursuant to a PGA or NS PGA, and (c) it is not a PIR.

The amount of the Forecast Fee shall be determined so as to recover the projected annual costs related to developing Energy forecasting systems, generating forecasts, validating forecasts, and monitoring forecast performance, which are incurred by the CAISO as a direct result of participation by EIRs in CAISO Markets, divided by the projected annual Energy production by all EIRs.

The current rate for the Forecast Fee is \$ 0.10 per MWh.

## A.17 Wind and Solar EIR Short Term Forecasting

- The ISO Automatic Load Forecasting System (ALFS) is configured to provide a day ahead (twenty four hourly forecasts) and short-term (5 minute) forecasts of wind generation and solar plant generation by resource. Two separate forecasts can be provided for each resource. The two forecasts are:
  - External Forecast (EXFC). This is an externally sourced forecast that is provided to the ISO. The forecast time resolution is hourly for the day ahead at the 5 minute level. The forecast will be for seven rolling hours,

---

rolling updated every five minutes. This forecast will be provided for every EIR.

- Scheduling Coordinator Forecast (SCFC). This is the forecast provided to the ISO by the certified SC. The SC must provide at a minimum a three-hour rolling forecast with fifteen- (15) minute granularity, updated every fifteen minutes, and may provide in the alternative a three-hour rolling forecast at five- (5) minute granularity, updated every five minutes. If a Scheduling Coordinator for an Eligible Intermittent Resource in the CA ISO Balancing Authority Area opts to provide the forecast at a five-minute granularity, the CA ISO will use the average of the projected Energy output for the relevant three five (5)-minute forecasts to determine the Variable Energy Resource Self-Schedule for the Fifteen Minute Market. A Scheduling Coordinator forecast may not be available for every wind or solar resource.

Should either forecast appear to interfere with reliable grid operations, in the judgment of ISO operation, the forecasts may be overridden. See Market Operations for BPM for details

### **A.18 Missing Scheduling Coordinator Forecasts**

- The external forecast will replace the Scheduling Coordinator forecast for consumption of the downstream systems in the following cases:
  - Should the Scheduling Coordinator forecast not be delivered.
  - The Scheduling Coordinator opts not to provide a forecast.
  - For periods beyond those submitted by the Scheduling Coordinator up to the forecast will be provided from the external forecaster,

## **Attachment B**

# **COMPETITIVE PATH ASSESSMENT**

## **B. Competitive Path Assessment**

The Dynamic Competitive Path Assessment used for Local Market Power Mitigation is described in section B.1 below. In cases where the Dynamic Competitive Path Assessment is unable to function, and when evaluating mitigation for exceptional dispatches in real-time, a default Competitive Path Assessment list is used instead for mitigation. The process for compiling this list is described in section B.2 below.

### **B.1 Dynamic Competitive Path Assessment (DCPA)**

#### **B.1.1 Accounting For Resource Control**

The purpose of a pivotal supplier test is to determine whether one or more suppliers defined on a portfolio basis can influence market prices through withholding. In the Day-Ahead Market, combining physical and net virtual supply that correspond to a single supplier is necessary to accurately account for the extent of withholding and resulting market impact. By comparison, in the HASP and RTUC, the extent of withholding and resulting market impact is determined based solely on the physical supply, because there is no virtual supply in those markets. The aggregation of related resources is referred to as a portfolio for purposes of conducting the pivotal supplier test - the potential that one or more suppliers' portfolios may be withheld and have an impact on the market.

Resources will be assigned to a supplier's portfolio based on the Scheduling Coordinator who owns the SCID assigned to the resource unless a different Scheduling Coordinator, or an Affiliate of a different Scheduling Coordinator, controls the resource. Then the resource will be excluded from the portfolio of the Scheduling Coordinator who owns the SCID assigned to the resource. The resource will be added to the supplier portfolio of the Scheduling Coordinator who controls the resource or whose Affiliate controls the resource.

Furthermore, Scheduling Coordinators who are registered with the ISO as distinct legal entities (or companies) may be or have Affiliates. The supplier portfolios of affiliated Scheduling



---

Coordinators will be combined in order to accurately account for the extent of possible withholding and resulting market impact.

Please refer to the BPM for Scheduling Coordinator Certification and Termination information on Scheduling Coordinator obligations to report Affiliates and resource control agreements.

➤ **Resources and Suppliers Considered**

1. Resources

a. Day-Ahead Market

All resources that are available will be considered, whether committed or not.

a. HASP

Only resources which are either on-line or offline and have a startup time of 60 minutes or less will be considered.

b. RTUC

Only resources which are either on-line or offline and have a startup time of 15 minutes or less will be considered.

2. Net Sellers as Potentially Pivotal Suppliers:

For determination of the top three potentially pivotal suppliers:

- The supplier portfolios of net sellers of electricity will be considered.
- Net buyers of electricity do not have an incentive to exercise local market power and increase spot wholesale prices.
- Identification of net buyers to exclude from the set of potentially pivotal suppliers will be determined quarterly. It will be determined by subtracting metered supply from the metered demand of each supplier portfolio over the most recent 12 month period.
- SCs without physical resources, for example purely financial SCs, cannot be deemed net buyers per the definition of net buyer in CAISO Tariff section 39.7.2.2 and therefore will always be categorized as net sellers.

### 3. Cleared Convergence Bids included (not applicable for real-time)

Cleared virtual supply bids are included in the demand for counterflow and effective supply calculations for fringe competitive suppliers.

## B.1.2 Process Flow for the Dynamic Competitive Path Assessment (DCPA) In the Day Ahead and Real Time Market:

The DCPA will determine which constraints are competitive and which constraints are non-competitive for each interval of the IFM, HASP, and RTUC. The DCPA will be assessed as part of the MPM process prior to each market.

DCPA formula for Generating Resources:

On Regulation	IFM	RTM
Withheld capacity	$-\min(0, SF) * (\min(\min(UOL, URL) - RU - SR - NR, UEL) - \max(\max(LOL, LRL) - RD, ESS))$	$-\min(0, SF) * (\min(DOT(t-1) + RRU(DOT(t-1), T), \min(UOL, URL) - RU - SR - NR, UEL - SR - NR, EDMAX - \delta * (RU + SR + NR)) - \max(DOT(t-1) + RRD(DOT(t-1), T), \max(LOL, LRL) - RD, ESS, EDMIN - \delta * RD))$
Supply counter flow from potential pivotal supplier	$-\min(0, SF) * \max(\max(LOL, LRL) - RD, ESS)$	$-\min(0, SF) * \max(DOT(t-1) + RRD(DOT(t-1), T), \max(LOL, LRL) - RD, ESS, EDMIN - \delta * RD)$
Supply counter flow from fringe competitive supplier	$-\min(0, SF) * \min(\min(UOL, URL) - RU - SR - NR, UEL)$	$-\min(0, SF) * \min(DOT(t-1) + RRU(DOT(t-1), T), \min(UOL, URL) - RU - SR - NR, UEL - SR - NR, EDMAX - \delta * (RU + SR + NR))$
Demand for counter flow	$-\min(0, SF) * EN$	$-\min(0, SF) * DOT(t)$
Off Regulation	IFM	RTM
Withheld capacity	$-\min(0, SF) * (\min(UOL - SR - NR, UEL) - \eta * \max(LOL, ESS))$	$-\min(0, SF) * (\min(DOT(t-1) + RRU(DOT(t-1), T), \min(UOL, UEL) - SR - NR, EDMAX - \delta * (SR + NR)) - \max(DOT(t-1) + RRD(DOT(t-1), T), LOL, ESS, EDMIN))$

Supply counter flow from potential pivotal supplier	$-\min(0, SF) * \eta * \max(\text{LOL}, \text{ESS})$	$-\min(0, SF) * \max(\text{DOT}(t-1) + \text{RRD}(\text{DOT}(t-1), T), \text{LOL}, \text{ESS}, \text{EDMIN})$
Supply counter flow from fringe competitive supplier	$-\min(0, SF) * \min(\text{UOL} - \text{SR} - \text{NR}, \text{UEL})$	$-\min(0, SF) * \min(\text{DOT}(t-1) + \text{RRU}(\text{DOT}(t-1), T), \min(\text{UOL}, \text{UEL}) - \text{SR} - \text{NR}, \text{EDMAX} - \delta * (\text{SR} + \text{NR}))$
Demand for counter flow	$-\min(0, SF) * \text{EN}$	$-\min(0, SF) * \text{DOT}(t)$

DCPA formula for Non-Generating Resources (NGR):

On Regulation	IFM	RTM
Withheld capacity	$-\min(0, SF) * (\min(\min(\text{UOL}, \text{URL}) - \text{RU} - \text{SR} - \text{NR}, \text{UEL}, \text{LSS}) - \max(\max(\text{LOL}, \text{LRL}) - \text{RD}, \text{LEL}, \text{GSS}))$	$-\min(0, SF) * (\min(\text{DOT}(t-1) + \text{RRU}(\text{DOT}(t-1), T), \min(\text{UOL}, \text{URL}) - \text{RU} - \text{SR} - \text{NR}, \text{UEL} - \text{SR} - \text{NR}, \text{LSS}, \text{EDMAX} - \delta * (\text{RU} + \text{SR} + \text{NR})) - \max(\text{DOT}(t-1) + \text{RRD}(\text{DOT}(t-1), T), \max(\text{LOL}, \text{LRL}) - \text{RD}, \text{LEL}, \text{GSS}, \text{EDMIN} - \delta * \text{RD}))$
Supply counter flow from potential pivotal supplier	$-\min(0, SF) * [\max(\max(\text{LOL}, \text{LRL}) - \text{RD}, \text{LEL}, \text{GSS}) - \text{LOL}]$	$-\min(0, SF) * [\max(\text{DOT}(t-1) + \text{RRD}(\text{DOT}(t-1), T), \max(\text{LOL}, \text{LRL}) - \text{RD}, \text{LEL}, \text{GSS}, \text{EDMIN} - \delta * \text{RD}) - \text{LOL}]$
Supply counter flow from fringe competitive supplier	$-\min(0, SF) * [\min(\min(\text{UOL}, \text{URL}) - \text{RU} - \text{SR} - \text{NR}, \text{UEL}, \text{LSS}) - \text{LOL}]$	$-\min(0, SF) * [\min(\text{DOT}(t-1) + \text{RRU}(\text{DOT}(t-1), T), \min(\text{UOL}, \text{URL}) - \text{RU} - \text{SR} - \text{NR}, \text{UEL} - \text{SR} - \text{NR}, \text{LSS}, \text{EDMAX} - \delta * (\text{RU} + \text{SR} + \text{NR})) - \text{LOL}]$
Demand for counter flow	$-\min(0, SF) * (\text{EN} - \text{LOL})$	$-\min(0, SF) * (\text{DOT}(t) - \text{LOL})$
Off Regulation	IFM	RTM
Withheld capacity	$-\min(0, SF) * (\min(\text{UOL} - \text{SR} - \text{NR}, \text{UEL}, \text{LSS}) - \max(\text{LOL}, \text{LEL}, \text{GSS}))$	$-\min(0, SF) * (\min(\text{DOT}(t-1) + \text{RRU}(\text{DOT}(t-1), T), \min(\text{UOL}, \text{UEL}) - \text{SR} - \text{NR}, \text{LSS}, \text{EDMAX} - \delta * (\text{SR} + \text{NR})) - \max(\text{DOT}(t-1) + \text{RRD}(\text{DOT}(t-1), T), \text{LOL}, \text{LEL}, \text{GSS}, \text{EDMIN}))$

Supply counter flow from potential pivotal supplier	$-\min(0, SF) * [\max(\text{LOL}, \text{LEL}, \text{GSS}) - \text{LOL}]$	$-\min(0, SF) * [\max(\text{DOT}(t-1) + \text{RRD}(\text{DOT}(t-1), T), \text{LOL}, \text{LEL}, \text{GSS}, \text{EDMIN}) - \text{LOL}]$
Supply counter flow from fringe competitive supplier	$-\min(0, SF) * [\min(\text{UOL} - \text{SR} - \text{NR}, \text{UEL}, \text{LSS}) - \text{LOL}]$	$-\min(0, SF) * [\min(\text{DOT}(t-1) + \text{RRU}(\text{DOT}(t-1), T), \min(\text{UOL}, \text{UEL}) - \text{SR} - \text{NR}, \text{LSS}, \text{EDMAX} - \delta * (\text{SR} + \text{NR})) - \text{LOL}]$
Demand for counter flow	$-\min(0, SF) * (\text{EN} - \text{LOL})$	$-\min(0, SF) * (\text{DOT}(t) - \text{LOL})$

Where

ESS	is the Energy Self-Schedule
$\eta$	is a binary variable that is set if the resource is must-run because of ESS or spin self-provision

UOL	is the Upper Operating Limit
URL	is the Upper Regulating Limit
UEL	is the Upper Economic Limit
LOL	is the Lower Operating Limit
LRL	is the Lower Regulating Limit
LEL	is the Lower Economic Limit
GSS	is the Generating Self-Schedule
LSS	is the Load Self-Schedule
RU	is the Regulation Up self-schedule
RD	is the Regulation Down self-schedule
SR	is the Spinning Reserve self-schedule
NR	is the Non-Spinning Reserve self-schedule
DOT(t)	is the optimal dispatch at interval t
RRU(DOT(t), T)	is the upward ramp capability from DOT(t) for interval duration T
RRD(DOT(t), T)	is the downward ramp capability from DOT(t) for interval duration T
EDMAX	is the MAXGOTO ED/MD
EDMIN	is the MINGOTO ED/MD
$\delta$	is the binary option to adjust ED/MD for AS

## B.2 Default Competitive Path Assessment list

The default competitive path assessment (default CPA) list will be used in order to determine whether exceptional dispatches are related to a non-competitive Transmission Constraint for purposes of mitigation of the exceptional dispatches in real-time.

In addition, the default CPA list will be used as a back-up measure in the event that a failure of the CAISO's market software prevents the software from performing the DCPA portion of the LMPM process. The default CPA list will be used in lieu of the dynamically produced list.

Methodology:

The default CPA will be calculated based on following methodology:

Subject to the exceptions discussed below, a Transmission Constraint that passes the following two thresholds will be deemed competitive for purposes of (1) mitigating exceptional dispatches in real-time and (2) determining whether the Transmission Constraint is competitive in the event of a failure of the CAISO's market software. Otherwise, the Transmission Constraint will be deemed non-competitive.

- Congestion Threshold: Congested in 10 or more hours in the run where the dynamic competitive path assessment is calculated, and
- Competitive Threshold: Deemed competitive in 75 percent or more of the instances where the constraint was binding when tested.

Input data will reflect the most recent 60 days of trade dates available at the time of testing.

An exception to the thresholds described above will apply to Path 15 and Path 26. Each of these two paths will be considered competitive unless the Transmission Constraint was congested in 10 or more hours in the test period and was deemed competitive less than 75 percent of the time. This exception allows these major inter-zonal interfaces to remain competitive even when they have not been binding in the past 60 days.

The CAISO will create separate lists of competitive Transmission Constraints for the Day-Ahead and Real-Time processes, based on data relevant to each market. For the Real-Time Market, if the Transmission Constraint was binding during any 15-minute interval during an hour, then the Transmission Constraint will be deemed to be binding for the entire hour. If the Transmission

Constraint was determined to be non-competitive during any 15-minute interval during an hour, then the Transmission Constraint will be deemed to be non-competitive for the entire hour.

This set of designations will be updated not less frequently than every seven days to reflect changes in system and market conditions.

# **Attachment C**

## **EXPECTED ENERGY CALCULATION**

## C. Expected Energy Calculation

### C.1 Expected Energy Definition

Expected Energy is the total Energy that is expected to be generated or consumed by a resource, based on the Dispatch of that resource, as calculated by the Real-Time Market (RTM), and as finally modified by any applicable DOP corrections. Expected Energy includes the Energy scheduled in the Integrated Forward Market and it is calculated “after-the-fact,” i.e., after the Operating Day. Expected Energy is calculated for Generating Units, System Resources, Resource-Specific System Resources, Non-Generator Resources, and Participating Loads (e.g, pumps). The calculation is based on the Day -Ahead Schedule and the Dispatch Operating Point (DOP) trajectory for the three-hour period around the target Trading Hour (including the previous and following hours), the applicable Real-Time LMP for each Dispatch Interval of the target Trading Hour, and any Exceptional Dispatch Instructions. All Dispatch Intervals are five minutes in duration.

For energy categories Real-Time Minimum Load Energy, Real-Time Pumping Energy, Derate Energy, Exceptional Dispatch Energy, and Optimal Energy, separate expected energy calculations are made for the Fifteen-Minute Market (FMM) dispatch and Real-Time Dispatch (RTD). These are denoted with a subscript, i.e.  $OE_{15}$  denotes Optimal Energy from the FMM dispatch and  $OE_5$  denotes Optimal Energy from the RTD.



The following is a list of Expected Energy types and their general descriptions. How each are calculated is described in Section D.3, Expected Energy Calculation.

Expected Energy Category	Definition	Published Enumeration
Day-Ahead Scheduled Energy (DASE)	Hourly Energy that corresponds to the flat hourly Day-Ahead Schedule (DAS). It is composed of Day-Ahead Minimum Load Energy, Day-Ahead Self-Scheduled Energy, and Day-Ahead Bid Awarded Energy. It does not include the DA Energy that corresponds to the flat schedule when resource is committed in DA pumping mode. Expected energy in DA pumping mode is accounted for as DA pumping energy. Day-Ahead Scheduled Energy includes the DA Energy that corresponds to the negative schedule when the non-generator resource is dispatched to consume energy (i.e. charging). Day-Ahead Scheduled Energy is settled at the IFM LMP as specified in Section 11.2.1.1. of the CAISO Tariff.	DASE
Day-Ahead Minimum Load Energy (DAMLE) [This only includes IFM Min load Energy]	DASE below the Minimum Load (as registered in the Master File, or if the Minimum Load is re-rated per section 9.3.3. of the ISO tariff, the Minimum Load amount here will be as re-rated); it applies to Generating Units with non-zero Minimum Load. DAMLE will be zero for non-generator resources in the initial base model. DAMLE is paid the Day-Ahead LMP as reflected in Section 11.2.1.1 of the CAISO Tariff and it is included in Bid Cost Recovery (BCR) at the relevant DA Minimum Load Cost (MLC) as reflected in Section 11.8.2.1.2 of the CAISO Tariff.	DMLE
Day-Ahead Self Scheduled Energy (DASSE)	DASE above the higher of the Minimum Load (as registered in the Master File, or if the Minimum Load is re-rated per section 9.3.3. of the ISO tariff, the Minimum Load amount here will be as re-rated) and below the lower of the Day-Ahead Total Self-Schedule (DATSS) or the DAS. The DATSS is the sum of all Day-Ahead Self-Schedules (except Pumping Self-Schedules) in the relevant Clean Bid. DASSE is paid the Day-Ahead LMP as reflected in Section 11.2.1.1 of the CAISO Tariff and as indicated in Section 11.8.2.1.5 of the CAISO Tariff. It is not included in BCR.	DSSE

Expected Energy Category	Definition	Published Enumeration
Day-Ahead Bid Awarded Energy (DABAE)	DASE above the DATSS and below the DAS. DABAE is also indexed against the relevant DA Energy Bid and sliced by Energy Bid price. The DABAE slices are paid the Day-Ahead LMP as reflected in Section 11.2.1.1 of the CAISO Tariff and they are included in BCR at the cost of the relevant DA Energy Bid prices as shown in Section 11.8.2.1.5 of the CAISO Tariff.	DABE
Day-Ahead Pumping Energy (DAPE)	Negative DASE consumed by Pumped-Storage Hydro (PSH) and Pump Resources Scheduled in pumping mode in DA. When DAPE is present, there are no other DASE subtypes present. DAPE is charged the Day -Ahead LMP as reflected in Section 11.2.1.3 of the CAISO Tariff and it is included in BCR at the relevant DA Pumping Cost as demonstrated in Section 11.8.2.1.4 of the CAISO Tariff.	DAPE
Standard Ramping Energy (SRE)	IIE produced or consumed in the first two and the last two Dispatch Intervals due to hourly schedule changes. SRE is a schedule deviation along a linear symmetric 20-min ramp (“standard ramp”) across hourly boundaries. SRE is always present when there is an hourly schedule change, including resource Start-Ups and Shut-Downs. SRE does not apply to Non-Dynamic System Resources (including Resource-Specific System Resources) or to Proxy Demand Resources electing to be dispatched in Hourly Blocks or fifteen (15) minute intervals. SRE is not subject to settlement as shown in Section 11.5.1 of the CAISO Tariff.	SRE
Ramping Energy Deviation (RED)	IIE produced or consumed due to deviation from the standard ramp because of ramp constraints, Start-Up, or Shut-Down. RED may overlap with SRE, and both SRE and RED may overlap with DASE, but with no other IIE subtype. RED may be composed of two parts: a) the part that overlaps with SRE whenever the DOP crosses the SRE region; and b) the part that does not overlap with SRE. The latter part of RED consists only of <i>extra-marginal</i> IIE contained within the hourly schedule change band and not attributed to Exceptional Dispatch or derates. RED does not apply to Non-Dynamic System	RED

Expected Energy Category	Definition	Published Enumeration
	Resources (including Resource-Specific System Resources) or to Proxy Demand Resources electing to be dispatched in Hourly Blocks or fifteen (15) minute intervals. RED is paid/charged the Real-Time LMP as reflected in Section 11.5.1 of the CAISO Tariff and it is included in BCR only for market revenue calculations as reflected in Section 11.8.1.4.5 of the CAISO Tariff.	
Residual Imbalance Energy (RIE)	Extra-marginal IIE produced or consumed at the start or end of a Trading Hour outside the hourly schedule-change band and not attributed to Exceptional Dispatch. RIE is due to a Dispatch Instruction in the Trading Hour before the current Trading Hour or a Dispatch Instruction in the Trading Hour after the current Trading Hour. RIE may overlap only with DASE. RIE does not apply to Non-Dynamic System Resources (including Resource-Specific System Resources) or to Proxy Demand Resources electing to be dispatched in Hourly Blocks or fifteen (15) minute intervals. RIE is settled as bid, based on the RT Energy Bid of the <i>reference hour</i> , or at the Real-Time LMP if there is no Bid as reflected in Section 11.5.1 of the CAISO Tariff, and it is not included in BCR as reflected in Section 11.8.4 of the CAISO Tariff. The <i>reference hour</i> is 1) the Trading Hour before the current trading hour that causes the residual energy, if RIE occurs at the start of a Trading Hour, or 2) the Trading Hour after the current trading hour that causes the residual energy, if RIE occurs at the end of a Trading Hour. Note, for Eligible Intermediate Resources RIE is settled at the RTD LMP for all RIE energy above the resource's forecasted output for the applicable settlement interval, as reflected in Section 11.5.5.2 of the CAISO Tariff.	RE
MSS Load Following Energy (MSS LFE)	IIE, exclusive of SRE, RED, and RIE, produced or consumed due to Load Following by an MSS. LFE is the IIE that corresponds to the algebraic Qualified Load Following Instruction (QLFI) relative to the DAS. LFE does not overlap with SRE, RED, or RIE, but it may overlap with DASE, Derate Energy, Exceptional Dispatch Energy, Real-Time Self-Scheduled Energy, and Optimal Energy. MSS LFE is paid/charged the Real-Time LMP as reflected in Section 11.5.1 of the CAISO Tariff and it is not included in BCR as reflected in Section	MSSLFE

Expected Energy Category	Definition	Published Enumeration
	11.8.4 of the CAISO Tariff.	
Real-Time Pumping Energy (RTPE)	IIE from PSH or Pump Resources, exclusive of SRE, RED, consumed below the DAS when Dispatched in pumping mode, or produced from pumping operation due to Pumping Level reduction in real time, including pump shut-down. RTPE does not overlap with any other Expected Energy type. RTPE is calculated separately based on the FMS or the DOP and charged or paid the FMM or RTD LMP as reflected in Section 11.5.1 of the CAISO Tariff and it is included in BCR at the relevant pumping Cost as reflected in Section 11.8.4.1.4 of the CAISO Tariff.	RTPE
Real-Time Minimum Load Energy (RTMLE)	IIE, exclusive of SRE, RED, and RIE, produced due to the Minimum Load of a Generating Unit that is committed in the RUC or the RTM (i.e., without a Day-Ahead Schedule) or a Constrained Output Generator (COG) that is committed in the IFM with a DAS below the registered Minimum Load (because COGs are modeled as flexible in the IFM). If the resource is committed in RTM for Load Following, RTMLE is accounted as MSSLFE instead. RTMLE is IIE above the Day-Ahead Schedule (or zero if there is no DAS) and below the Minimum Load (as registered in the Master File, or as re-rated per section 9.3.3. of the ISO tariff). RTMLE does not overlap with any other Expected Energy type. RTMLE will be zero in the initial base model. RTMLE is calculated separately based on the FMS or the DOP and paid the FMM and RTD LMP as reflected in Section 11.5.1 of the CAISO Tariff and it is included in BCR at the relevant minimum load cost as reflected in Section 11.8.4.1.2 of the CAISO Tariff. IIE that is consumed when a resource that is scheduled in the DAM is shut down in the RTM is accounted as Optimal Energy and not as RTMLE.	MLE
Derate Energy (DRE)	Extra-marginal IIE, exclusive of SRE, RED, RIE, LFE, and RTMLE, produced or consumed due to Minimum Load overrates or Maximum Capacity de-rates. DRE is produced above the higher of the DAS or the registered Minimum Load, and below the lower of the overrated Minimum Load and the DOP, or consumed below the lower of the DAS and above the higher of the de-rated	SE

Expected Energy Category	Definition	Published Enumeration
	<p>Maximum Capacity or the DOP. There could be two DRE slices, one for the Minimum Load overrate, and one for the Maximum Capacity de-rate. DRE does not overlap with SRE, RED, RIE, RTMLE, Exceptional Dispatch Energy, or Optimal Energy, but it may overlap with DASE and LFE. DRE is calculated separately based on the FMS or the DOP and paid/charged the FMM or RTD LMP as reflected in Section 11.5.1 of the CAISO Tariff and it is not included in BCR as reflected in Section 11.8.4 of the CAISO Tariff.</p> <p>Ramping energy in the intervals before or after the minimum load re-rate can be classified as de-rate energy if the ramping is incurred due to the de-rate.</p>	
Exceptional Dispatch Energy (EDE)	<p>Extra-marginal IIE, exclusive of SRE, RED, RIE, LFE, RTMLE, and DRE, produced or consumed due to manual (non-economic) Exceptional Dispatch Instructions that are binding in the relevant Dispatch Interval. Without MSS Load Following, EDE is produced above the <i>LMP index</i> and below the lower of the DOP or the Exceptional Dispatch instruction, or consumed below the <i>LMP index</i> and above the higher of the DOP or the Exceptional Dispatch Instruction. The LMP index is the capacity in the relevant Energy Bid that corresponds to a bid price equal to the relevant LMP. EDE does not overlap with SRE, RED, RIE, RTMLE, DRE, or Optimal Energy, but it may overlap with DASE and LFE. Exceptional Dispatch Energy is calculated separately based on the FMS or the DOP and paid/charged at a price that is specific to its type, either as-Bid or at the FMM or RTD LMP if there is no Bid as reflected in Section 11.5.6 of the CAISO Tariff, and it is not included in BCR as reflected in Section 11.8.4 of the CAISO Tariff..</p> <p>Ramping energy in the intervals before or after the Exceptional Dispatch Instruction can be classified as Exceptional Dispatch Energy if the ramping is due to the Exceptional Dispatch.</p>	EDE
Optimal Energy (OE) — also referred to as In-	Any remaining IIE after accounting for all other IIE subtypes constitutes OE. OE does not overlap with SRE, RED, RIE, RTMLE, DRE, and EDE, but it may overlap with DASE and LFE. OE is indexed against the relevant Energy Bid	OE

Expected Energy Category	Definition	Published Enumeration
Sequence or Optimal Energy	and sliced by service type, depending on the AS capacity allocation on the Energy Bid. OE is also divided into two parts: a) the part of OE that overlaps with MSS LFE (“Overlapping OE”), which is paid/charged the Real-Time LMP as reflected in Section 11.5.1, and it is not included in BCR since it is effectively cancelled by MSS LFE as reflected in Section 11.8.4 of the CAISO Tariff; and b) the remaining part (“Non-overlapping OE”), which is indexed against the relevant Energy Bid and sliced by Energy Bid price. The OE is calculated separately based on the FMS or the DOP. Non-overlapping OE slices are paid/charged the FMM or RTD LMP as reflected in Section 11.5.1 of the CAISO Tariff and they are included in BCR at the cost of the relevant Energy Bid prices as reflected in Section 11.8.4 of the CAISO Tariff. Any OE slice below or above the Energy Bid has no associated Energy Bid price and is settled as reflected in Section 11 of the CAISO Tariff and it is not included in BCR as reflected in Section 11 of the CAISO Tariff.	
RMR Energy (RMRE)	Total Expected Energy under RMR Dispatch. This energy is calculated irrelevant to other Expected Energy type and it may overlap with any other Expected Energy type. It is used for RMR contract based settlement as provided in Section 11 of the CAISO Tariff.	RMRE

## C.2 Expected Energy Calculation

The following section is meant to specify the formulas to calculate various Expected Energy amounts in a deterministic fashion. All the following calculations take place for each Dispatch Interval (5-minute) in the target hour on resource level base.

Note: The following algorithm includes a generic set of formulas to calculate expected energy for non-generator resources (NGR). This set of formulas reflects the ISO's intent to implement future revisions to the base NGR model. The ISO is publishing these formulas as part of the initial release of the base NGR model for administrative convenience and to provide stakeholders with greater transparency regarding the ISO's planned NGR model revisions. These formulas will allow the ISO to reflect a non-zero value for an NGR's minimum generation level and minimum load level. For purposes of the initial release of the NGR base model, the minimum generation level and minimum load level will both equal zero. When interpreting the algorithm for the NGR base model, the following conversion can be used for data mapping purpose,

<i>S<sub>NGR</sub></i>	Set of Non-Generating Resources; These are the Resources that market participants explicitly register to ISO's Master File as NGR resources.
<i>G<sub>MIN</sub></i>	Registered Minimum Load at Generating Side of NGR resources. This is a zero or positive number. For the NGR base model, it is always zero and market participants can not register this value.
<i>G<sub>MAX</sub></i>	Registered Maximum Capacity at Generating Side of NGR resources. This is a positive number. For the NGR base model, market participants register this value to ISO's Master File as Pmax of the NGR resource.
<i>L<sub>MIN</sub></i>	Registered Minimum Load at Load Side of NGR resources. This is a zero or negative number. For the NGR base model, it is always zero and market participants can not register this value.
<i>L<sub>MAX</sub></i>	Registered Maximum Capacity at Load Side of NGR resources. This is a negative number. For the NGR base model, market participants register this value to ISO's Master File as Pmin of the NGR resource.
<i>GRTLOL</i>	Real-Time Lower Operating Limit at Gen Side; it reflects Minimum Load overrates at Gen Side. This function does not exist in the NGR base model. It is always zero in the NGR base model.
<i>GRTUOL</i>	Real-Time Upper Operating Limit at Gen Side; it reflects Maximum Capacity derates at Gen Side. In the NGR base

model, this value reflects the capacity impact to the Pmax when market participant submits an outage/de-rate to ISO's OMS application.

*LRTL* Real-Time Lower Operating Limit at Load Side; it reflects Minimum Load overrates at Load Side. This function does not exist in the NGR base model. It is always zero in the NGR base model.

*LRTUOL* Real-Time Upper Operating Limit at Load Side; it reflects Maximum Capacity de-rates at Load Side. In the NGR base model, this value reflects the capacity impact to the Pmin when market participant submits a re-rate to ISO's OMS application.

### C.2.1 Top-level Algorithm

The following notation is used in the algorithm:

<i>∴</i>	For...
<i>∴</i>	If...
<i>i</i>	Resource index.
	.
<i>h</i>	Trading Hour index in the target Trading Day.
<i>N</i>	Number of Trading Hours in the target Trading Day.
<i>k</i>	RTD Dispatch 5-minute interval index from the start of the Trading Hour.
<i>f</i>	FMM Dispatch 15-minute interval index from the start of a Trading Hour.
<i>j</i>	Exceptional Dispatch Instruction index.
<i>l</i>	<i>DOT</i> sequence index from consecutive RTD, RTCD, or RTDD runs, as applicable.
<i>P</i>	Resource power output.
<i>t</i>	Time.
<i>T</i>	Time limit.
<i>m</i>	Market Type (DA, FMM, or RTD)



---

$T_l$	<i>DOT</i> timestamp for <i>DOT</i> sequence <i>l</i> . This is the mid-interval points (2.5 minutes middle point for 5-minute dispatch; 7.5 minutes middle point for 15-minute dispatch; or 5 minute middle point for 10-minute RTCD dispatch).
$T_{h,k}$	End time of Dispatch Interval <i>k</i> in Trading Hour <i>h</i> ; $T_{h,0}$ is the start of Trading Hour <i>h</i> .
$T_0$	Shorthand notation for $T_{1,0}$ : the start of the target Trading Day.
$T_N$	Shorthand notation for $T_{N,12}$ : the end of the target Trading Day.
$TF_{LOL}$	Forward overrated lower operating limit extension time limit for Generating Resources. This applies to market type $m = \text{RTD, FMM}$ .
$TB_{LOL}$	Backward overrated lower operating limit extension time limit for Generating Resources. This applies to market type $m = \text{RTD, FMM}$ .
$TF_{GLOL}$	Forward overrated lower generating operating limit extension time limit for NGR. This applies to market type $m = \text{RTD, FMM}$ .
$TB_{GLOL}$	Backward overrated lower generating operating limit extension time limit for NGR. This applies to market type $m = \text{RTD, FMM}$ .
$TF_{LLOL}$	Forward overrated lower load operating limit extension time limit for NGR. This applies to market type $m = \text{RTD, FMM}$ .
$TB_{LLOL}$	Backward overrated lower load operating limit extension time limit for NGR. This applies to market type $m = \text{RTD, FMM}$ .
$TF_{ED}$	Forward Exceptional Dispatch instruction extension time limit. This applies to market type $m = \text{RTD, FMM}$ .
$TB_{ED}$	Backward Exceptional Dispatch instruction extension time limit. This applies to market type $m = \text{RTD, FMM}$ .
$TF_{ref}$	Forward <i>RIE</i> terminating reference time.
$TB_{ref}$	Backward <i>RIE</i> terminating reference time.
$NULL$	No value.
$S_{GEN}$	Set of Generating Units.
$S_{TIE}$	Set of Resource-Specific System Resources.
$S_{IMP}$	Set of Import System Resources; $S_{IMP} \subseteq S_{TIE}$ .

---

$S_{EXP}$	Set of Export System Resources; $S_{EXP} \subseteq S_{TIE}$ .
$S_{HPD}$	Set of Non-Dynamic System Resources; $S_{HPD} \subseteq S_{GEN} \cup S_{TIE}$ .
$S_{HDR}$	Set of Proxy Demand Resources electing be dispatched in Hourly Blocks or fifteen (15) minute intervals; $S_{HDR} \subseteq S_{GEN}$
$S_{RMR}$	Set of RMR Resources; $S_{RMR} \subseteq S_{GEN}$
$S_{PSH}$	Set of Pumped-Storage Hydro (PSH) Resources; $S_{PSH} \subseteq S_{GEN}$
$S_{PUMP}$	Set of Pump (Participating Load) Resources; $S_{PUMP} \subseteq S_{GEN}$
$S_{MSS}$	Set of MSS Load Following Resources; $S_{MSS} \subseteq S_{GEN} \cup S_{IMP}$ , $(S_{MSS} \cap S_{GEN}) \cap S_{HPD} = \emptyset$ .
$S_{TG}$	Set of Resource-Specific System Resources; $S_{TG} \subseteq S_{GEN}$ .
$S_{NGR}$	Set of Non-Generating Resources; (Resources that are characterized by explicit identification of NGR resource)
$S_{EIM}$	Set of all EIM resources. These are resources which are located within an EIM Entity. $S_{EIM} \subseteq S_{GEN} \cup S_{TIE}$
$S_{EIMP}$	Set of EIM Participating Resources. $S_{EIMP} \subseteq S_{EIM}$
$S_{EIMNPR}$	Set of EIM non-participating resources. These resources do not participate in the Real-Time Market. $S_{EIMNPR} \subseteq S_{EIM}$
$G_{MIN}$	Registered Minimum Load at Generating Side of NGR resources. This is a zero or positive number. It is assumed 0 for the NGR base model.
$G_{MAX}$	Registered Maximum Capacity at Generating Side of NGR resources. This is a positive number. It is assumed constant.
$L_{MIN}$	Registered Minimum Load at Load Side of NGR resources. This is a zero or negative number. It is assumed 0 for the NGR base model.
$L_{MAX}$	Registered Maximum Capacity at Load Side of NGR resources. This is a negative number. It is assumed constant.
$P_{MIN}$	Registered Minimum Load; it is assumed constant.

---

<i>P<sub>MAX</sub></i>	Registered Maximum Capacity; it is assumed constant.
<i>PL</i>	Pumping Level for Pumped-Storage Hydro and Pump Resources. (5-minute for market type $m = \text{RTD}$ or 15-minute for market type $m = \text{FMM}$ ).
<i>DALEL</i>	Day-Ahead Lower Economic Limit; the bottom of the Day-Ahead mitigated Energy Bid.
<i>DAUEL</i>	Day-Ahead Upper Economic Limit; the top of the Day-Ahead mitigated Energy Bid.
<i>DALOL</i>	Day-Ahead Lower Operating Limit; it reflects Minimum Load overrates. $\forall i \notin S_{NGR}$
<i>RTLLOL</i>	Real-Time Lower Operating Limit; it reflects Minimum Load overrates. $\forall i \notin S_{NGR}$ This applies to market type $m = \text{RTD}, \text{FMM}$ .
<i>RTUOL</i>	Real-Time Upper Operating Limit; it reflects Maximum Capacity derates. $\forall i \notin S_{NGR}$ This applies to market type $m = \text{RTD}, \text{FMM}$ .
<i>GRTLLOL</i>	Real-Time Lower Operating Limit at Gen Side; it reflects $G_{\min}$ Load overrates at Gen Side. This applies to NGR resources only, and it is assumed 0 for the NGR base model. $\forall i \in S_{NGR}$ This applies to market type $m = \text{RTD}, \text{FMM}$ .
<i>GRTUOL</i>	Real-Time Upper Operating Limit at Gen Side; it reflects $G_{\max}$ derates at Gen Side. This applies to NGR resources only. $\forall i \in S_{NGR}$ This applies to market type $m = \text{RTD}, \text{FMM}$ .
<i>LRTLLOL</i>	Real-Time Lower Operating Limit at Load Side; it reflects $L_{\min}$ overrates at Load Side. This applies to NGR resources only, and it is assumed 0 for the NGR base model. $\forall i \in S_{NGR}$ This applies to market type $m = \text{RTD}, \text{FMM}$ .
<i>LRTUOL</i>	Real-Time Upper Operating Limit at Load Side; it reflects $L_{\max}$ derates at Load Side. This applies to NGR resources only. $\forall i \in S_{NGR}$ This applies to market type $m = \text{RTD}, \text{FMM}$ .
<i>RTLEL</i>	Real-Time Lower Economic Limit; the bottom of the mitigated Real-Time Energy Bid.
<i>RTUEL</i>	Real-Time Upper Economic Limit; the top of the mitigated Real-Time Energy Bid.
<i>RTCS</i>	Real-Time Commitment Status (5-minute for market type $m = \text{RTD}$ or 15-minute for market type $m = \text{FMM}$ ) (0: offline; 1: generating; -1: pumping; for Generating Units; 1: online for non-generator resources in both gen side or load side; 1 for all others).

---

<i>RTBP(p)</i>	Real-Time mitigated Energy Bid function; bid price versus power output.
<i>DAS</i>	Day-Ahead Schedule.
<i>DASE</i>	Day-Ahead Scheduled Energy.
<i>DAMLE</i>	Day-Ahead Minimum Load Energy.
<i>DAMLGE</i>	Day Ahead Minimum Load - Generation Energy; the Day-Ahead Energy attributed to $G_{\min}$ for NGR
<i>DAMLLE</i>	Day Ahead Minimum Load - Load Energy; the Day-Ahead Energy attributed to $L_{\min}$ for NGR
<i>DASSE</i>	Day-Ahead Self-Scheduled Energy.
<i>DABAE</i>	Day-Ahead Bid Awarded Energy.
<i>DAPE</i>	Day-Ahead Pumping Energy.
<i>BASE</i>	Energy calculated for submitted Base Schedules. Applies to EIM resources.
<i>FMS</i>	15-minute Schedule of FMM market.
<i>RFMS(t)</i>	Ramping Fifteen Minute Schedule (RFMS) is the continuous piecewise linear curve connecting consecutive <i>FMS</i> 's using their mid-interval points, from FMM runs.
<i>RTBS</i>	Real-Time Base Schedule for ECA/ACA Resources. (5-minute for market type $m = \text{RTD}$ or 15-minute for market type $m = \text{FMM}$ ). RTBS is assumed to be zero for all resources.
<i>RTBD</i>	Real-Time Base Deviation. (5-minute for market type $m = \text{RTD}$ or 15-minute for market type $m = \text{FMM}$ ). RTBD is assumed to be zero for all resources.
<i>BSEIM</i>	Real-Time Base Schedule for EIM resources. Hourly value, submitted by resources within the EIM balancing authority area..
<i>DOT</i>	Dispatch Operating Target.
<i>DOP(t)</i>	Dispatch Operating Point function; expected resource power output versus time.
<i>S(t)</i>	DOP Slope Direction function versus time for RTD market, or RFMS Slope Direction function versus time for FMM market.
<i>SR(t)</i>	Standard Ramp function; expected resource scheduled power output, including the 20-min linear ramp across hourly boundaries, if applicable, versus time.

---

<i>RTLMP</i>	Real-Time Locational Marginal Price (5-minute for market type $m = \text{RTD}$ or 15-minute for market type $m = \text{FMM}$ ).
<i>RTTGSS</i>	Real-Time Total Generating Self-Schedule for NGR
<i>RTTLSS</i>	Real-Time Total Self-Schedule for NGR
<i>RTLED</i>	Real-Time Lower unconstrained Economic Dispatch based on the LMP and the Energy Bid. The LMP corresponds to 5-minute RTD LMP or 15-minute FMM LMP depending on market type $m$ .
<i>RTUED</i>	Real-Time Upper unconstrained Economic Dispatch based on the LMP and the Energy Bid. The LMP corresponds to 5-minute RTD LMP or 15-minute FMM LMP depending on market type $m$ .
<i>MD<sub>MIN</sub></i>	Minimum EIM Manual Dispatch. This corresponds to market type $m = \text{RTD}$ , FMM.
<i>MD<sub>MAX</sub></i>	Maximum EIM Manual Dispatch. This corresponds to market type $m = \text{RTD}$ , FMM.
<i>MD<sub>FIX</sub></i>	Fixed EIM Manual Dispatch. This corresponds to market type $m = \text{RTD}$ , FMM.
<i>MD<sub>BND</sub></i>	Binding EIM Manual Dispatch. This corresponds to market type $m = \text{RTD}$ , FMM.
<i>ED<sub>MIN</sub></i>	Minimum Exceptional Dispatch. This corresponds to market type $m = \text{RTD}$ , FMM.
<i>ED<sub>MAX</sub></i>	Maximum Exceptional Dispatch. This corresponds to market type $m = \text{RTD}$ , FMM.
<i>ED<sub>FIX</sub></i>	Fixed Exceptional Dispatch. This corresponds to market type $m = \text{RTD}$ , FMM.
<i>ED<sub>BND</sub></i>	Binding Exceptional Dispatch. This corresponds to market type $m = \text{RTD}$ , FMM.
<i>QLFI</i>	Qualified Load Following Instruction for non-HPD Load Following Resources, relative to Day-Ahead Schedule. (5-minute for market type $m = \text{RTD}$ or 15-minute for market type $m = \text{FMM}$ ). 15-min FMM QLFI shall be the simple average of the relevant 5-minute RTD QLFI's.
<i>DASR</i>	Day-Ahead Reference Schedule.
<i>FMSR</i>	15-Minute Reference Schedule.
<i>IIE</i>	Instructed Imbalance Energy. This applies to market type $m = \text{RTD}$ , FMM
<i>BED</i>	Base Energy Deviation. This applies to market type $m = \text{RTD}$ , FMM. BED is assumed to be zero for all resources
<i>SRE</i>	Standard Ramping Energy.
<i>EXME</i>	Extra-Marginal Energy.
<i>RED</i>	Ramping Energy Deviation. This applies to market type $m = \text{RTD}$ , FMM. However, The total RED shall be settled

---

	as 5 minute RTD values.
<i>ORED</i>	Overlapping Ramping Energy Deviation. This applies to market type $m = \text{RTD, FMM}$ .
<i>NRED</i>	Non-overlapping Ramping Energy Deviation. This applies to market type $m = \text{RTD, FMM}$ .
<i>GNRED</i>	Non-Overlapping Ramping Energy Deviation for NGR in generating mode. This applies to market type $m = \text{RTD, FMM}$ .
<i>LNRED</i>	Non-Overlapping Ramping Energy Deviation for NGR in load mode. This applies to market type $m = \text{RTD, FMM}$ .
<i>RIE</i>	Residual Imbalance Energy. This applies to market type $m = \text{RTD, FMM}$ . However, The total RIE shall be settled as 5 minute RTD values.
<i>TRIE</i>	Top of the hour RIE. This applies to market type $m = \text{RTD, FMM}$ .
<i>GTRIE</i>	Top of the hour RIE for NGR in generating mode. This applies to market type $m = \text{RTD, FMM}$ .
<i>LTRIE</i>	Top of the hour RIE for NGR in load mode. This applies to market type $m = \text{RTD, FMM}$ .
<i>BRIE</i>	Bottom of the hour RIE. This applies to market type $m = \text{RTD, FMM}$ .
<i>GBRIE</i>	Bottom of the hour RIE for NGR in generating mode. This applies to market type $m = \text{RTD, FMM}$ .
<i>LBRIE</i>	Bottom of the hour RIE for NGR in load mode. This applies to market type $m = \text{RTD, FMM}$ .
<i>RTMLE</i>	Real-Time Minimum Load Energy. This applies to market type $m = \text{RTD, FMM}$ .
<i>RTMLGE</i>	Real Time Minimum Generating Energy; the Real-Time Energy attributed to $G_{\min}$ for NGR. This applies to market type $m = \text{RTD, FMM}$ .
<i>RTMLLE</i>	Real Time Minimum Load Energy; the Real-Time Energy attributed to $L_{\min}$ for NGR. This applies to market type $m = \text{RTD, FMM}$ .
<i>RTPE</i>	Real-Time Pumping Energy. This applies to market type $m = \text{RTD, FMM}$ .
<i>DRE</i>	Derate Energy. This applies to market type $m = \text{RTD, FMM}$ .
<i>UDRE</i>	Upper Derate Energy due to $P_{\max}$ derates. This applies to market type $m = \text{RTD, FMM}$ .
<i>GUDRE</i>	Generating Upper Derate Energy due to $G_{\max}$ derates. This applies to market type $m = \text{RTD, FMM}$ .
<i>LUDRE</i>	Load Upper Derate Energy due to $L_{\max}$ derates. This applies to market type $m = \text{RTD, FMM}$ .
<i>LDRE</i>	Lower Derate Energy due to $P_{\min}$ overrates. This applies to market type $m = \text{RTD, FMM}$ .

---

<i>GLDRE</i>	Generating Lower Derate due to $G_{\min}$ overrates. This applies to market type $m = \text{RTD, FMM}$ .
<i>LLDRE</i>	Load Lower Derate Energy due to $L_{\min}$ overrates. This applies to market type $m = \text{RTD, FMM}$ .
<i>MSS</i> <i>LFE</i>	MSS Load Following Energy. This applies to market type $m = \text{RTD, FMM}$ . However, The total LFE shall be settled as 5 minute RTD values.
<i>MDE</i>	EIM Manual Dispatch Energy. This applies to market type $m = \text{RTD, FMM}$ .
<i>EDE</i>	Exceptional Dispatch Energy. This applies to market type $m = \text{RTD, FMM}$ .
<i>OE</i>	Optimal Energy. This applies to market type $m = \text{RTD, FMM}$ .
<i>OOE</i>	Overlapping Optimal Energy. This applies to market type $m = \text{RTD, FMM}$ .
<i>GOOE</i>	Overlapping Optimal Energy for NGR in generating mode. This applies to market type $m = \text{RTD, FMM}$ .
<i>LOOE</i>	Overlapping Optimal Energy for NGR in load mode. This applies to market type $m = \text{RTD, FMM}$ .
<i>NOE</i>	Non-overlapping Optimal Energy. This applies to market type $m = \text{RTD, FMM}$ .
<i>GNOE</i>	Non-Overlapping Optimal Energy for NGR in generating mode. This applies to market type $m = \text{RTD, FMM}$ .
<i>LNOE</i>	Non-Overlapping Optimal Energy for NGR in load mode. This applies to market type $m = \text{RTD, FMM}$ .
<i>TOL</i>	Configurable tolerance used in integral termination time calculation; set by default to 0.005 MW.
<i>RAMPT</i>	Ramping Tolerance expected energy.
<i>TEE</i>	Total Expected Energy (based on <i>DOP</i> ).
<i>TTEE</i>	Total Target Expected Energy (based on <i>RDOT</i> ).
<i>RDOT(t)</i>	Ramping Dispatch Operating Target; a continuous piecewise linear curve connecting consecutive <i>DOTs</i> using their mid-interval points, from RTD, RTCD, or RTDD runs, as applicable.

All capacity quantities are in MW, all energy quantities are in MWh, all prices are in \$/MWh, and time is in sec.

**Expected Energy Calculation Algorithm**

Any absent variables are considered zero. For example, a missing DAS is considered zero. Energy quantities are zero by default when the relevant conditions in their formula do not hold. One exception to this rule, given an interval and a resource, if the resource is not committed or within the Start Up/shutdown period in DA or RT, there should be no Expected Energy and allocation calculated. This is to avoid a lot of zero Expected Energy being calculated. The following formula is assuming a principle of “No DOP No Expected Energy”.

The Total Self-Schedule is the sum of all self-schedules except pumping self-schedules. The Energy Bid, and thus the Lower/Upper Economic Limits are relative to the Total Self-Schedule. The Lower Economic Limit is equal to the higher of the Total Self-Schedule or the Minimum Load. For NGRs, the Lower Economic Limit is equal to the bottom of the energy bid curve. The Upper Economic Limit is equal to the top of the Energy Bid. If there is no Energy Bid, the Upper Economic Limit is equal to the Lower Economic Limit.

The Lower Operating Limit is greater than or equal to the Minimum Load and it reflects Minimum Load overrates. The Minimum Load and the Lower Operating Limit for System Resources are both zero. The Upper Operating Limit is less than or equal to the Maximum Capacity and it reflects Maximum Capacity derates. The Maximum Capacity and the Upper Operating Limit for System Resources are both infinite.

In MQS 2.0, the following assumptions are also made to a pump or pump storage resource in pumping mode:

1. There will be no operating mode switch between FMM and RTD. If a resource is committed in pumping mode in FMM, it cannot change to any other mode except in the event of outage, which leads from pumping mode to offline;
2. For a resource in pumping, there is only one constant pumping level that this resource can operate on (constant pumping level);



3. When a resource is started up into pumping mode or shut down from pumping mode, the ramping is assumed infinite. A vertical line of DOP dispatch from zero to Pumping Level (startup) or vertical line of pumping level to zero (shutdown) is assumed;
4. When a pump storage switch between pumping mode and generation mode in any given market, it is assumed that it has to go through an offline period to meet the minimum down time requirement;
5. Schedules and DOPs in pumping mode are all negative MWs;
6. For all NGRs there will be an assumption that  $G_{min} = L_{min} = 0$ ; The NGR base model will not accommodate any resource where  $G_{min}$  or  $L_{min}$  is not 0.

Given those assumptions, the possible Expected Energy incurred by resources in pumping mode will be Standard Ramping Energy, Ramping Energy Deviation, Day-Ahead Pumping Energy and Real-Time Pumping Energy.

$$\begin{aligned}
 0 \leq P_{MINi} \leq DALOL_{i,h,k} \leq P_{MAXi} \quad \forall i \in S_{GEN} \cup S_{TIE} \cup S_{HPD} \cup S_{TG} \\
 0 \leq P_{MINi} \leq RTLEL_{i,h} \leq RTUEL_{i,h} \leq P_{MAXi} \quad \forall i \in S_{GEN} \cup S_{TIE} \cup S_{HPD} \cup S_{TG} \\
 0 \leq P_{MINi} \leq RTLOL_{i,h,k} \leq RTUOL_{i,h,k} \leq P_{MAXi} \quad \forall i \in S_{GEN} \cup S_{TIE} \cup S_{HPD} \cup S_{TG} \\
 \left. \begin{aligned}
 P_{MINi} = RTLOL_{i,h,k} = 0 \\
 P_{MAXi} = RTUOL_{i,h,k} = \infty
 \end{aligned} \right\} \quad \forall i \in S_{TIE}
 \end{aligned}$$

$$\left. \begin{aligned}
 L_{MAXi} \leq RTLEL_{i,h} \leq RTUEL_{i,h} \leq G_{MAXi} \\
 G_{MINi} \leq GRTLOL_{i,h,k} \leq GRTUOL_{i,h,k} \leq G_{MAXi} \\
 L_{MAXi} \leq LRTUOL_{i,h,k} \leq LRTLOL_{i,h,k} \leq L_{MINi}
 \end{aligned} \right\} \quad \because i \in S_{NGR}$$

$$\left. \begin{array}{l} G_{MINi} = 0 \\ L_{MINi} = 0 \end{array} \right\} \because i \in S_{NGR}$$

$$\left. \begin{array}{l} GRTLOL_{i,h,k} = 0 \\ LRTLOL_{i,h,k} = 0 \end{array} \right\} \because i \in S_{NGR}$$

### C.2.1.1 Day-Ahead Scheduled Energy

$$DASE_{i,h} = \max(0, DAS_{i,h}) \times 1hr \because i \notin S_{NGR}$$

$$DASE_{i,h} = DAS_{i,h} \times 1hr \because i \in S_{NGR}$$

### C.2.1.2 Day-Ahead Minimum Load Energy

$$DAMLE_{i,h} = \max(0, \min(DAS_{i,h}, DALOL_{i,h})) \times 1hr \because i \notin S_{NGR}$$

$$DAMLE_{i,h} \equiv DAMLGE_{i,h} + DAMLLE_{i,h} \because i \in S_{NGR}$$

$$DAMLGE_{i,h} = \max(0, \min(DAS_{i,h}, G_{MINi})) \times 1hr \because i \in S_{NGR}$$

$$DAMLLE_{i,h} = \min(0, \max(DAS_{i,h}, L_{MINi})) \times 1hr \because i \in S_{NGR}$$

Note: For NGR base model: Since  $G_{MINi}=0$ ,  $L_{MINi}=0$ , this will result in  $DAMLE_{i,h}=0$ .

### C.2.1.3 Day-Ahead Self Scheduled Energy

$$DASSE_{i,h} = \max(0, \min(DAS_{i,h}, DALEL_{i,h}) - (P_{MINi})) \times 1hr \quad \therefore i \notin S_{NGR}$$

$$DASSE_{i,h} = \begin{cases} \max(0, \min(DAS_{i,h}, DALEL_{i,h}) - G_{MINi}) \times 1hr & \therefore DAS_{i,h} \geq 0 \\ \min(0, \max(DAS_{i,h}, DAUEL_{i,h}) - L_{MINi}) \times 1hr & \therefore DAS_{i,h} < 0 \end{cases} \quad \therefore i \in S_{NGR}$$

### C.2.1.4 Day-Ahead Bid Awarded Energy

$$DABAE_{i,h} = \max(0, DAS_{i,h} - DALEL_{i,h}) \times 1hr \quad \therefore i \notin S_{NGR}$$

$$DABAE_{i,h} = \begin{cases} \max(0, DAS_{i,h} - \max(0, DALEL_{i,h})) \times 1hr & \therefore DAS_{i,h} \geq 0 \\ \min(0, DAS_{i,h} - \min(0, DAUEL_{i,h})) \times 1hr & \therefore DAS_{i,h} < 0 \end{cases} \quad \therefore i \in S_{NGR}$$

### C.2.1.5 Day-Ahead Pumping Energy

$$DAPE_{i,h} = \min(0, DAS_{i,h}) \times 1hr \quad \therefore i \notin S_{NGR}$$

### C.2.1.6 Block Energy Accounting Rules

The DOP of the following Resources is converted to a step function at the relevant DOTs for Expected Energy accounting as follows:

$$DOP_{i,h,k}(t) = DOT_{i,h,k} \quad \therefore T_{h,k-1} \leq t < T_{h,k}, \quad k = 1, 2, \dots, 12 \quad \forall i \in S_{TIE} \cup (S_{TG} \cap S_{HPD}) \quad \text{U}$$

### C.2.1.7 Instructed Imbalance Energy

$$\left\{ \begin{array}{l} IIE_{i,m,h,f} = \int_{T_{h,f-1}}^{T_{h,f}} \frac{(FMS_{i,h,f} - DAS_{i,h})}{3600} dt \quad \therefore m \in FMM \\ IIE_{i,m,h,k} = \int_{T_{h,k-1}}^{T_{h,k}} \frac{(DOP_{i,h}(t) - FMS_{i,h,f})}{3600} dt \quad \therefore m \in RTD \end{array} \right.$$

For Generating Units, System Resources, and Non-Generator Resources, positive Instructed Imbalance Energy is produced, whereas negative Instructed Imbalance Energy is consumed. The converse is true for Export System Resources, i.e., positive Instructed Imbalance Energy is consumed, whereas negative Instructed Imbalance Energy is produced.

Instructed Imbalance Energy Calculations for the FMM and RTD are illustrated graphically in Figure 1 below.

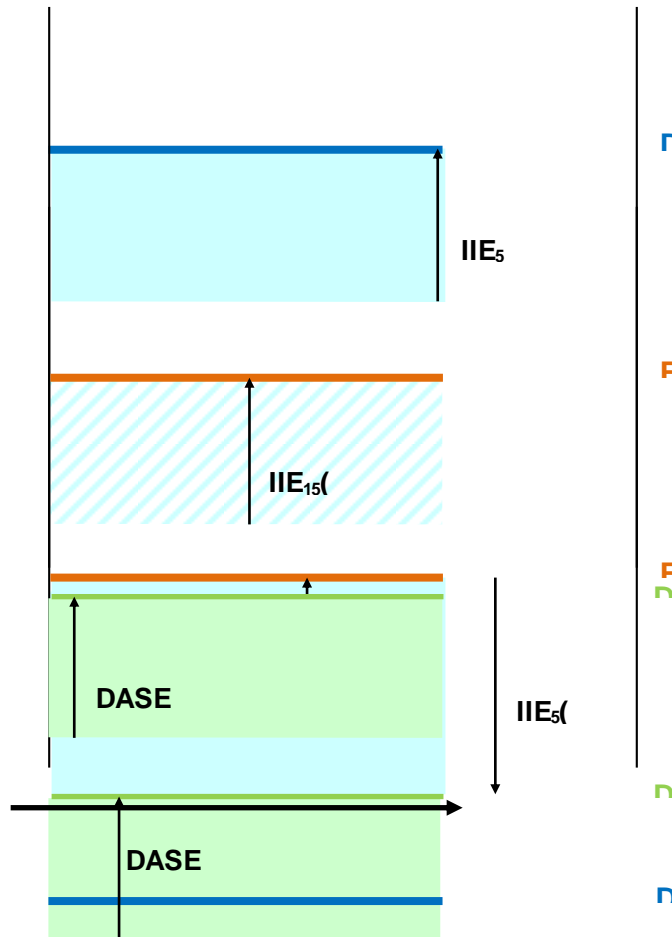

**Figure 1a Instructed Imbalance Energy for a Generating Resource. RTD DOP is greater than FMM schedule, which is greater than DA schedule.**

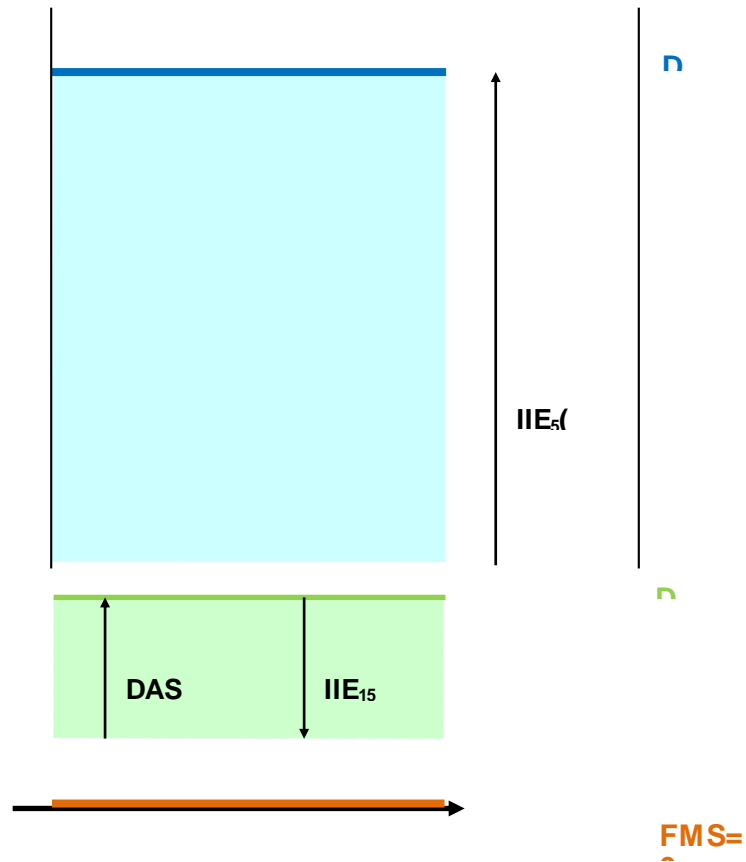

**Figure 1b Instructed Imbalance Energy for a Generating Resource. RTD DOP is less than FMM schedule and DA schedule, FMM is greater than DA schedule.**

### C.2.1.8 Standard Ramping Energy

The Standard Ramp function is defined as follows:

$$SR_{i,h}(t) = \begin{cases} DAS_{i,h} + \frac{DAS_{i,h-1} - DAS_{i,h}}{1200} (T_{h,2} - t) & \therefore T_{h,0} \leq t \leq T_{h,2} \\ DAS_{i,h} & \therefore T_{h,2} \leq t \leq T_{h,10} \\ DAS_{i,h} + \frac{DAS_{i,h+1} - DAS_{i,h}}{1200} (t - T_{h,10}) & \therefore T_{h,10} \leq t \leq T_{h,12} \\ DAS_{i,h} & \end{cases} \begin{cases} \therefore i \notin S_{HPD} \cup S_{TIE} \\ \therefore i \in S_{HPD} \cup S_{TIE} \end{cases}$$

The Standard Ramping Energy is calculated as follows:

$$SRE_{i,h,k} = \int_{T_{h,k-1}}^{T_{h,k}} \frac{(SR_{i,h}(t) - DAS_{i,h})}{3600} dt = \begin{cases} (DAS_{i,h-1} - DAS_{i,h})/32 & \therefore i \notin S_{HPD} \cup S_{TIE} \wedge k = 1 \\ (DAS_{i,h-1} - DAS_{i,h})/96 & \therefore i \notin S_{HPD} \cup S_{TIE} \wedge k = 2 \\ (DAS_{i,h+1} - DAS_{i,h})/96 & \therefore i \notin S_{HPD} \cup S_{TIE} \wedge k = 11 \\ (DAS_{i,h+1} - DAS_{i,h})/32 & \therefore i \notin S_{HPD} \cup S_{TIE} \wedge k = 12 \end{cases}$$

### C.2.1.9 MSS Load Following Energy

The MSS Load Following Energy is calculated as follows:

$$\left. \begin{array}{l}
 LFE_{i,m,h,f} = \left\{ \begin{array}{l}
 \int_{T_{h,f-1}}^{T_{h,f}} \frac{\min(0, DAS_{i,h} + QLFI_{i,m,h,f} - \min(DAS_{i,h}, SR_{i,h}(t)))}{3600} dt \quad \because QLFI_{i,m,h,f} < 0 \\
 \int_{T_{h,f-1}}^{T_{h,f}} \frac{\max(0, DAS_{i,h} + QLFI_{i,m,h,f} - \max(DAS_{i,h}, SR_{i,h}(t)))}{3600} dt \quad \because QLFI_{i,m,h,f} > 0
 \end{array} \right\} \quad \because m \in FMM \\
 \\
 LFE_{i,m,h,k} = \left\{ \int_{T_{h,k-1}}^{T_{h,k}} \frac{(QLFI_{i,m,h,k} - QLFI_{i,FMM,h,f})}{3600} dt \right\} \quad \because m \in RTD
 \end{array} \right\} \quad \because i \in S_{MSS}$$

$$LFE_{i,h,k} = LFE_{i,FMM,h,f} + LFE_{i,RTD,h,k} \quad \because i \in S_{MSS}$$

The total LFE shall be settled as 5 minute RTD values. Figure 2 graphically illustrates the concept.



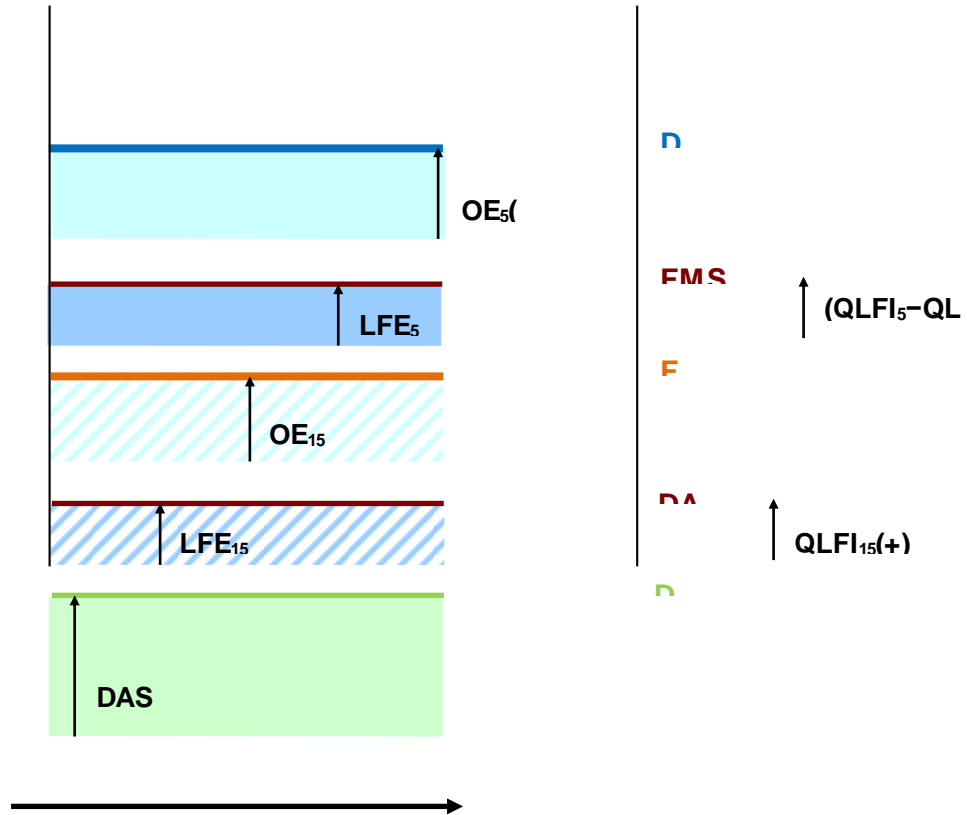

**Figure 2a Load Following Energy for a Generating Resource – Case A:  $QLFI_5 > QLF_{15} > 0$**

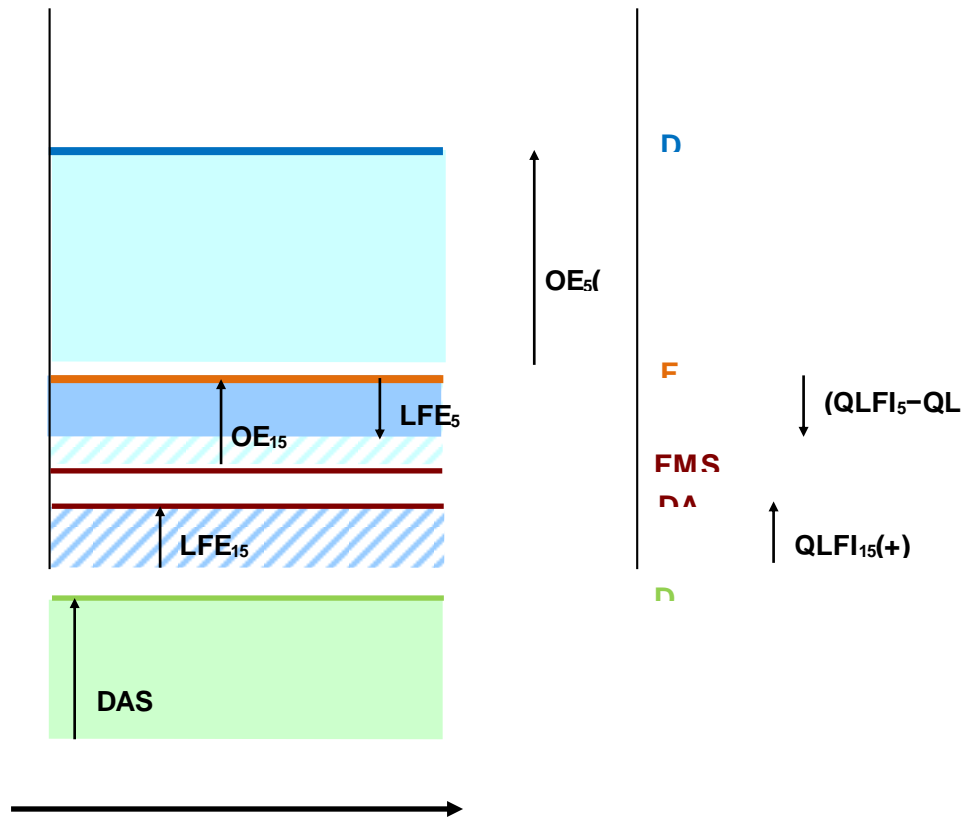

Figure 2b Load Following Energy for a Generating Resource – Case B:  $0 > QLFI_5 < QLFI_{15} > 0$

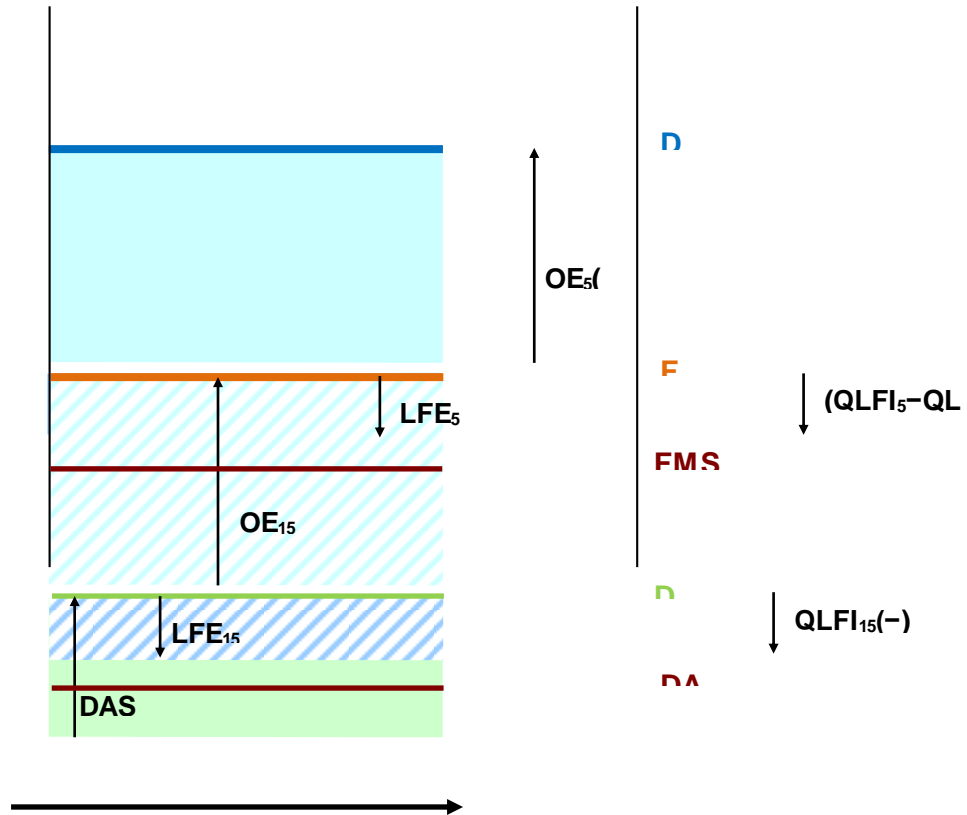

Figure 2c Load Following Energy for a Generating Resource – Case C:  $QLFI_5 < QLFI_{15} < 0$

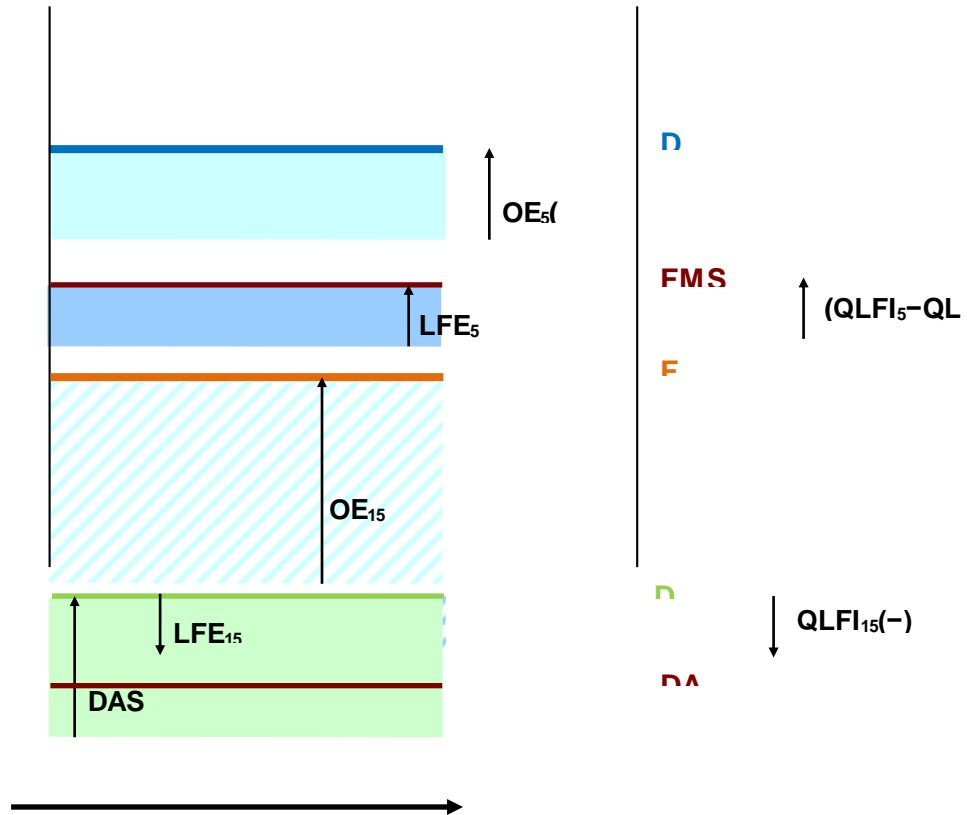

Figure 2d Load Following Energy for a Generating Resource – Case D:  $0 > QLFI_5 > QLFI_{15} < 0$

### C.2.1.10 Reference Schedule

To combine the distinct effects of Load Following in the formulae, it is convenient to define the following Reference Schedule function for DAS and FMS:

$$\left\{ \begin{array}{l} \left. \begin{array}{l} \text{DASR}_{i,h}(t) \equiv \text{DASR}_{i,h,f} \equiv \text{DAS}_{i,h} + \text{QLFI}_{i,m,h,f} \\ \text{FMSR}_{i,h}(t) \equiv \text{FMSR}_{i,h,k} \equiv \text{FMS}_{i,h,f} + (\text{QLFI}_{i,m,h,k} - \text{QLFI}_{i,FMM,h,f}) \end{array} \right\} \begin{array}{l} \therefore T_{h,f-1} \leq t < T_{h,f}, f = 1, 2, \dots, 4 \quad \therefore m \in \text{FMM} \\ \therefore T_{h,k-1} \leq t < T_{h,k}, k = 1, 2, \dots, 12 \quad \therefore m \in \text{RTD} \end{array} \right.$$

### C.2.1.11 Real-Time Pumping Energy

RTPE is the algebraic sum of negative IIE due to pumping increase and positive IIE due to pumping reduction, as follows:

$$\left\{ \begin{array}{l} \left. \begin{array}{l} \text{RTPE}_{i,m,h,f} = \left\{ \begin{array}{l} \int_{T_{h,f-1}}^{T_{h,f}} \frac{\min(0, \text{FMS}_{i,h,f} - \min(0, \text{DASR}_{i,h}(t), \text{DAS}_{i,h}, \text{SR}_{i,h}(t)))}{3600} dt + \\ \int_{T_{h,f-1}}^{T_{h,f}} \frac{\max(0, \min(0, \text{FMS}_{i,h,f}) - \max(\text{DASR}_{i,h}(t), \text{DAS}_{i,h}, \text{SR}_{i,h}(t)))}{3600} dt \end{array} \right\} \begin{array}{l} \therefore m \in \text{FMM} \\ \therefore i \in S_{\text{GEN}} \cup S_{\text{TIE}} \end{array} \\ \text{RTPE}_{i,m,h,k} = \left\{ \begin{array}{l} \int_{T_{h,k-1}}^{T_{h,k}} \frac{\min(0, \text{DOP}_i(t) - \min(0, \text{FMSR}_{i,h}(t), \text{FMS}_{i,h,f}))}{3600} dt + \\ \int_{T_{h,k-1}}^{T_{h,k}} \frac{\max(0, \min(0, \text{DOP}_i(t)) - \max(\text{FMSR}_{i,h}(t), \text{FMS}_{i,h,f}))}{3600} dt \end{array} \right\} \begin{array}{l} \therefore m \in \text{RTD} \end{array} \end{array} \right.$$

$$RTPE_{i,h,k} = 0 \because i \in S_{NGR}$$

The concept of Real-Time Pumping Energy is illustrated graphically in Figure 3.

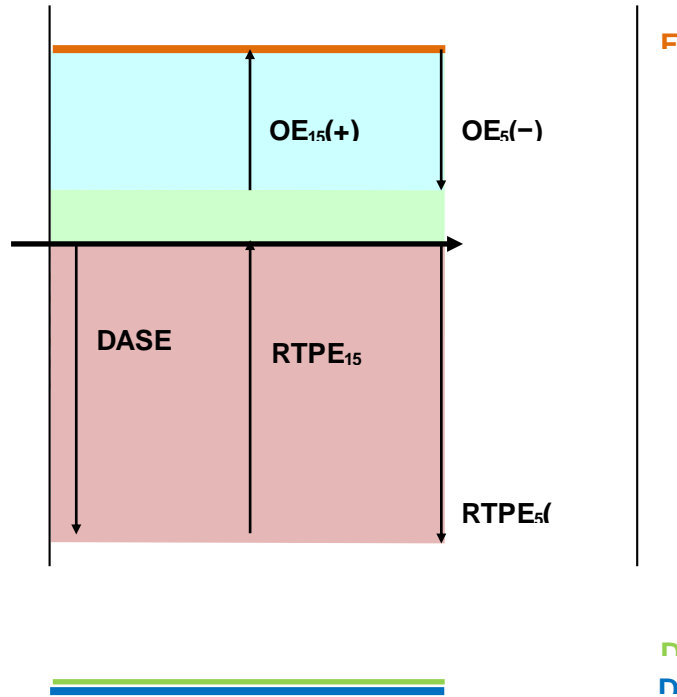

**Figure 3a Real-Time Pumping Energy for a Pump Storage Hydro Resource. RTD in pump mode, FMM in generation mode, DA in pump mode.**

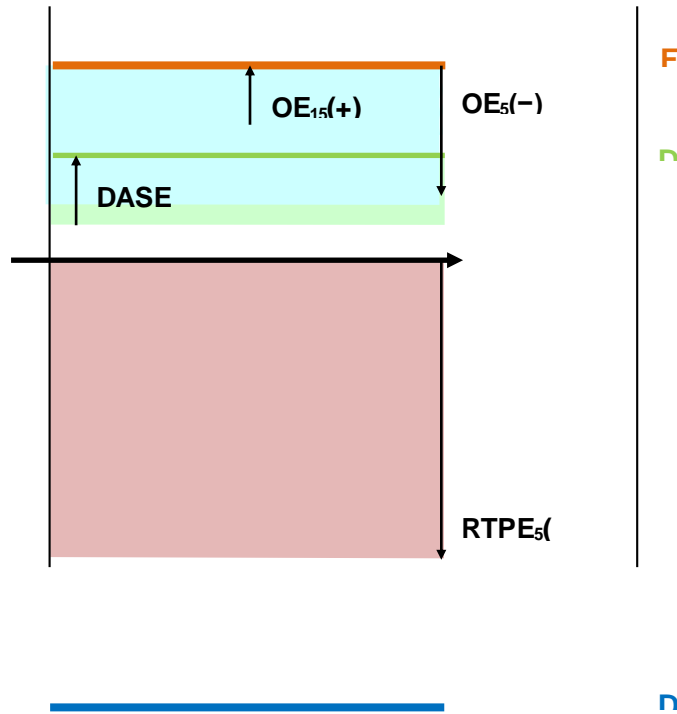

**Figure 3b Real-Time Pumping Energy for a Pump Storage Hydro Resource. RTD in pump mode, FMM and DA in generation mode. FMM schedule is greater than DA schedule.**

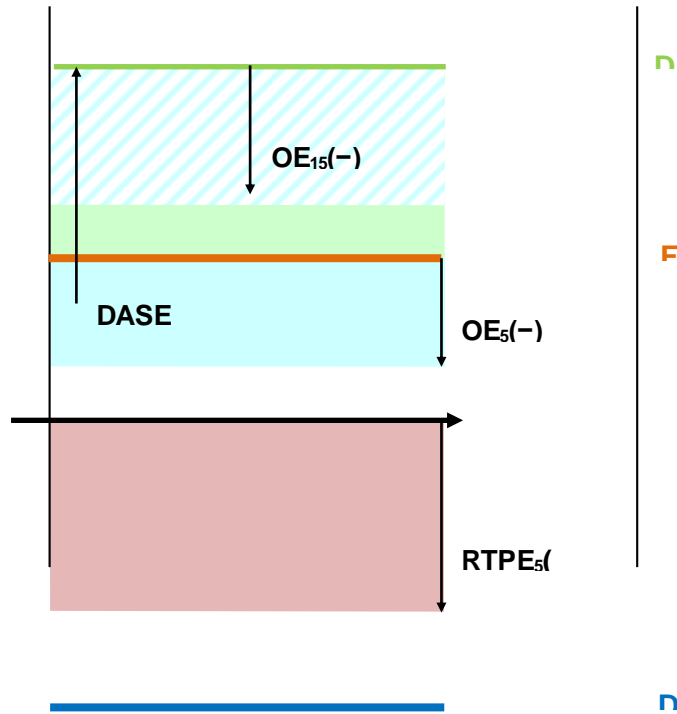

**Figure 3c Real-Time Pumping Energy for a Pump Storage Hydro Resource. RTD in pump mode, FMM and DA in generation mode. FMM schedule is greater than DA schedule.**



### C.2.1.12 Real-Time Minimum Load Energy

$$\left\{ \begin{array}{l} RTMLE_{i,m,h,f} = \int_{T_{h,f-1}}^{T_{h,f}} \frac{\max(0, \min(FMS_{i,h,f}, RTLOL_{i,m,h}) - \max(0, DASR_{i,h}(t), DAS_{i,h}, SR_{i,h}(t)))}{3600} dt \\ RTMLE_{i,m,h,k} = \int_{T_{h,k-1}}^{T_{h,k}} \frac{\max(0, \min(DOP_i(t), RTLOL_{i,m,h}) - \max(0, FMSR_{i,h}(t), FMS_{i,h,f}))}{3600} dt \end{array} \right\} \begin{array}{l} \therefore m \in FMM \\ \therefore m \in RTD \end{array} \left. \vphantom{\int} \right\} \therefore i \in S_{GEN} \cup S_{TIE}$$

$$RTMLE_{i,h,k} \equiv RTMLGE_{i,h,k} + RTMLLE_{i,h,k} \quad \therefore i \in S_{NGR}$$

$$\left\{ \begin{array}{l} RTMLGE_{i,m,h,f} = \int_{T_{h,f-1}}^{T_{h,f}} \frac{\max(0, \min(FMS_{i,h,f}, G_{MINi}) - \max(0, DASR_{i,h}(t), DAS_{i,h}, SR_{i,h}(t)))}{3600} dt \\ RTMLGE_{i,m,h,k} = \int_{T_{h,k-1}}^{T_{h,k}} \frac{\max(0, \min(DOP_i(t), G_{MINi}) - \max(0, FMSR_{i,h}(t), FMS_{i,h,f}))}{3600} dt \end{array} \right\} \begin{array}{l} \therefore m \in FMM \\ \therefore m \in RTD \end{array} \left. \vphantom{\int} \right\} \therefore i \in S_{NGR}$$

$$\left\{ \begin{array}{l} RTMLLE_{i,m,h,f} = \int_{T_{h,f-1}}^{T_{h,f}} \frac{\min(0, \max(FMS_{i,h,f}, L_{MINi}) - \min(0, DASR_{i,h}(t), DAS_{i,h}, SR_{i,h}(t)))}{3600} dt \\ RTMLLE_{i,m,h,k} = \int_{T_{h,k-1}}^{T_{h,k}} \frac{\min(0, \max(DOP_i(t), L_{MINi}) - \min(0, FMSR_{i,h}(t), FMS_{i,h,f}))}{3600} dt \end{array} \right\} \begin{array}{l} \therefore m \in FMM \\ \therefore m \in RTD \end{array} \left. \vphantom{\int} \right\} \therefore i \in S_{NGR}$$

The concept of Real-Time Minimum Load Energy is illustrated graphically in Figure 4. In the graphs, the term PMIN refers to RTLOL for Generating Resources.

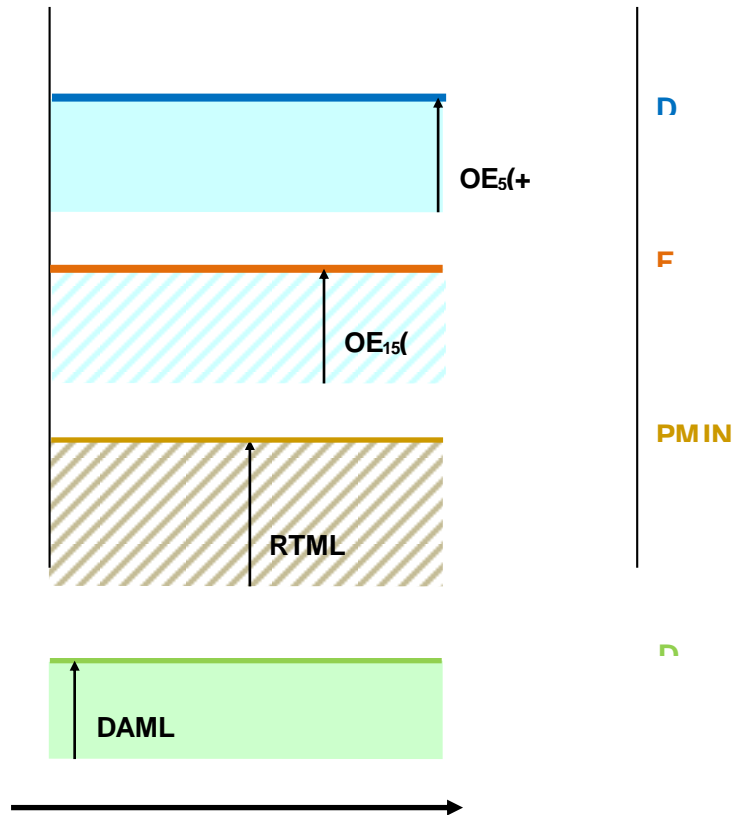

**Figure 4a Real-Time Minimum Load Energy for a COG Generating Resource. RTD dispatch greater than FMM schedule, which is greater than Pmin. DA schedule less than Pmin. RTMLE is applicable to the FMS only.**

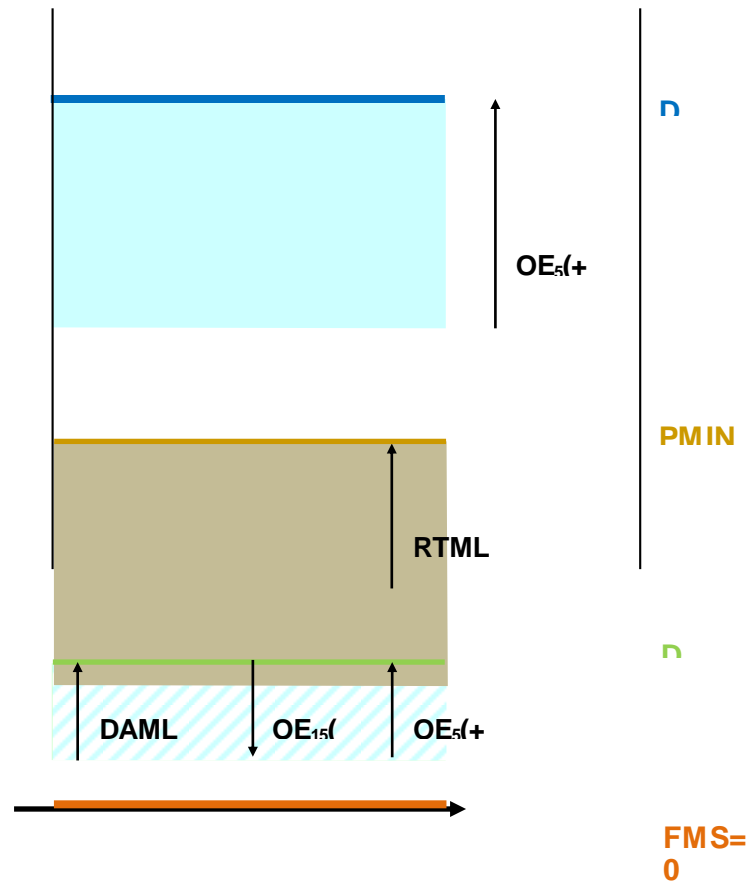

**Figure 4b Real-Time Minimum Load Energy for a COG Generating Resource. RTD dispatch above Pmin, FMM schedule is zero. DA schedule is below Pmin. RTMLE is applicable to the DOP.**

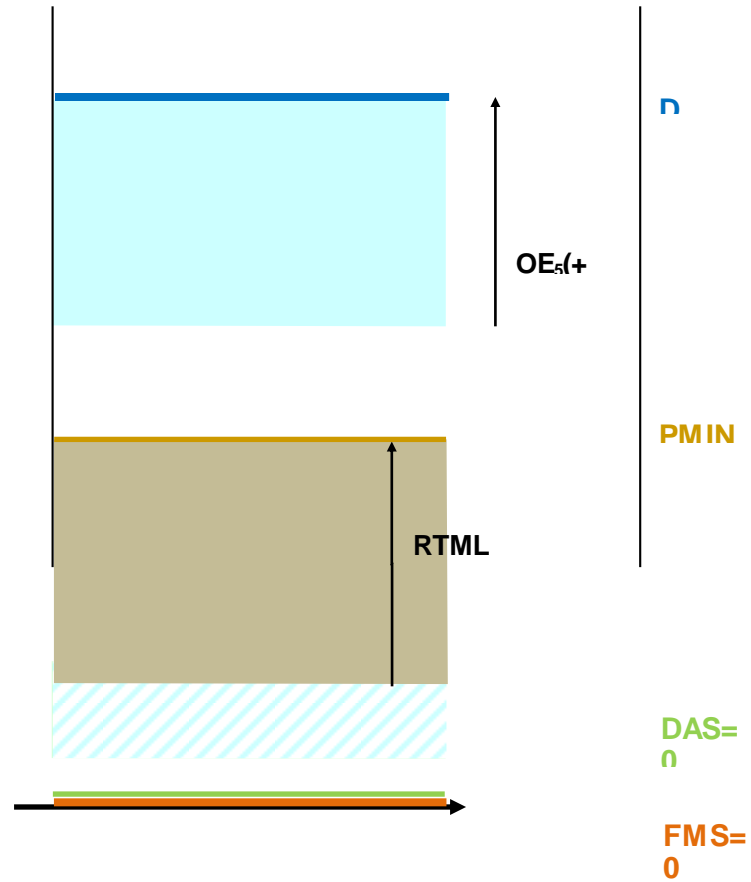

**Figure 4c Real-Time Minimum Load Energy for a Generating Resource. RTD dispatch above Pmin, FMM and DA schedules are zero. RTMLE is applicable to the DOP.**

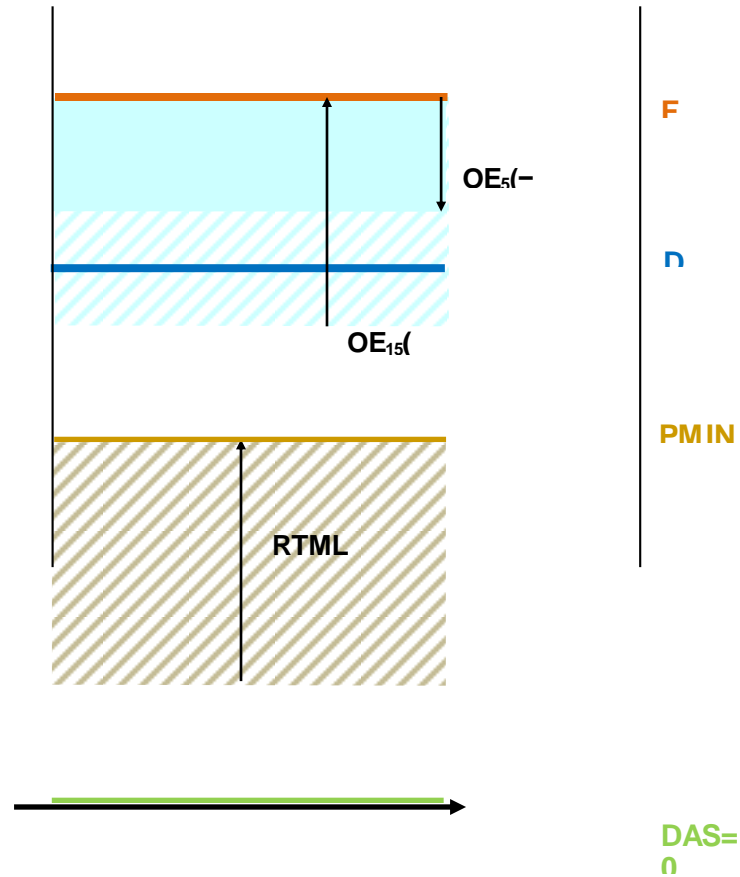

**Figure 4d Real-Time Minimum Load Energy for a Generating Resource. RTD dispatch and FMM schedule above Pmin, RTD dispatch is below FMM schedule. DA schedule is zero. RTMLE is applicable to the FMM schedule .**

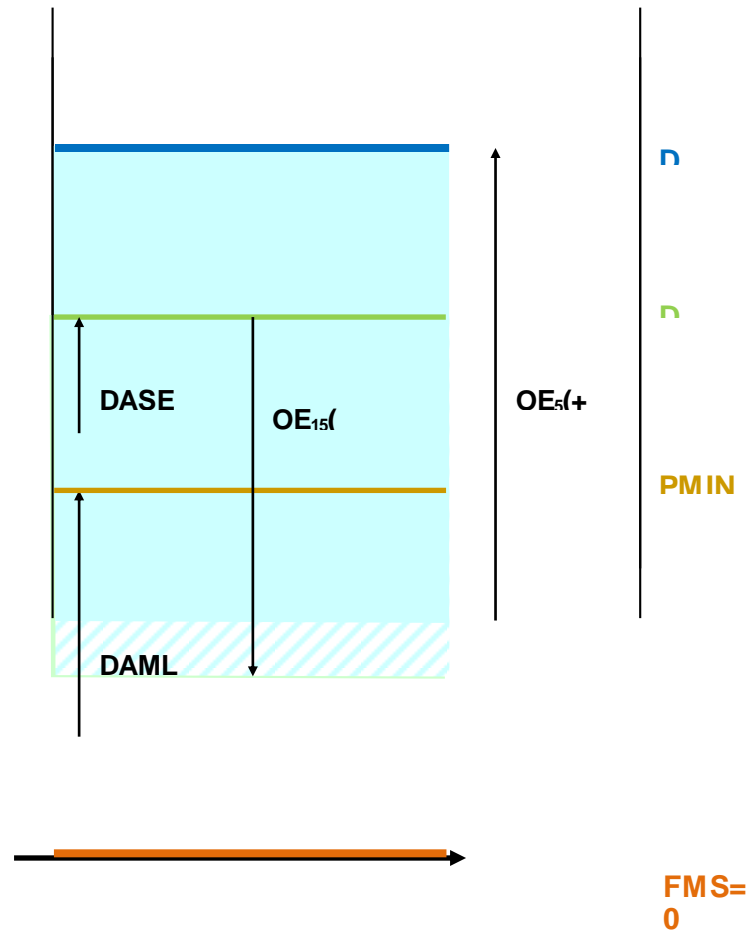

**Figure 4e Real-Time Minimum Load Energy for a Generating Resource. RTD dispatch above Pmin, FMM schedule is zero. DA schedule is above Pmin. Since the min load energy is covered by the DA schedule, there is no RTMLE.**

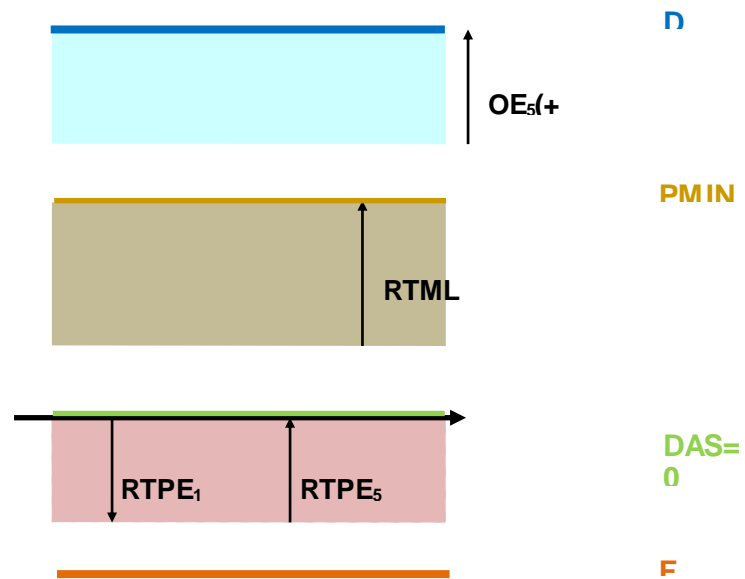

**Figure 4f Real-Time Minimum Load Energy for a Pump Storage Hydro Resource. RTD dispatch above Pmin, FMM schedule in pump mode. DA schedule is zero. RTMLE is applicable to the DOP.**



### C.2.1.13 Extra-Marginal Energy

Extra-Marginal Energy is either produced Instructed Imbalance Energy at a higher bid price than the Real-Time LMP or consumed Instructed Imbalance Energy at a lower bid price than the Real-Time LMP, exclusive of Standard Ramping Energy. For Generating Units in generating mode and Non-Generator resources and System Resources, Instructed Imbalance Energy without a bid price, i.e., below or above the Energy Bid, is considered to be bid at  $-\infty$  if it is lower than the Lower Economic Limit, and at  $+\infty$  if it is higher than the Upper Economic Limit. The converse is true for Export System Resources, i.e., Instructed Imbalance Energy is considered to be bid at  $+\infty$  if it is lower than the Lower Economic Limit, and at  $-\infty$  if it is higher than the Upper Economic Limit. For Pumped-Storage Hydro and Pump Resources in pumping mode, Instructed Imbalance Energy is considered to be bid at  $+\infty$  if it is higher than the Pumping Level, and at  $-\infty$  if it is lower than the Pumping Level.

To calculate Extra-Marginal Energy, the Real-Time LMP (5-minute for market type  $m = \text{RTD}$  or 15-minute for market type  $m = \text{FMM}$ ) must be indexed against the relevant Energy Bid as follows:

$$\left. \begin{array}{l}
 \left. \begin{array}{l}
 RTLED_{i,m,h,f} = \max p \quad \therefore RTBP_{i,h}(p) < RTLMP_{i,m,h,f} \\
 RTUED_{i,m,h,f} = \min p \quad \therefore RTBP_{i,h}(p) > RTLMP_{i,m,h,f} \\
 RTLED_{i,m,h,f} = RTUED_{i,m,h,k} = PL_{i,m}
 \end{array} \right\} \begin{array}{l}
 \therefore RTCS_{i,m,h,f} \geq 0 \\
 \therefore RTCS_{i,m,h,f} = -1
 \end{array} \right\} \therefore m \in FMM \\
 \\
 \left. \begin{array}{l}
 \left. \begin{array}{l}
 RTLED_{i,m,h,k} = \max p \quad \therefore RTBP_{i,h}(p) < RTLMP_{i,m,h,k} \\
 RTUED_{i,m,h,k} = \min p \quad \therefore RTBP_{i,h}(p) > RTLMP_{i,m,h,k} \\
 RTLED_{i,m,h,k} = RTUED_{i,m,h,k} = PL_{i,m}
 \end{array} \right\} \begin{array}{l}
 \therefore RTCS_{i,m,h,k} \geq 0 \\
 \therefore RTCS_{i,m,h,k} = -1
 \end{array} \right\} \therefore m \in RTD
 \end{array} \right\} \therefore i \notin S_{NGR}$$

$$\left\{ \begin{array}{l} RTLED_{i,m,h,f} = \max p \quad \therefore RTBP_{i,h}(p) < RTLMP_{i,m,h,f} \\ RTUED_{i,m,h,f} = \min p \quad \therefore RTBP_{i,h}(p) > RTLMP_{i,m,h,f} \end{array} \right\} \therefore m \in FMM$$

$$\left\{ \begin{array}{l} RTLED_{i,m,h,k} = \max p \quad \therefore RTBP_{i,h}(p) < RTLMP_{i,m,h,k} \\ RTUED_{i,m,h,k} = \min p \quad \therefore RTBP_{i,h}(p) > RTLMP_{i,m,h,k} \end{array} \right\} \therefore m \in RTD$$

$$\left. \begin{array}{l} \left\{ \begin{array}{l} RTLED_{i,m,h,f} = \max p \quad \therefore RTBP_{i,h}(p) < RTLMP_{i,m,h,f} \\ RTUED_{i,m,h,f} = \min p \quad \therefore RTBP_{i,h}(p) > RTLMP_{i,m,h,f} \end{array} \right\} \therefore m \in FMM \\ \left\{ \begin{array}{l} RTLED_{i,m,h,k} = \max p \quad \therefore RTBP_{i,h}(p) < RTLMP_{i,m,h,k} \\ RTUED_{i,m,h,k} = \min p \quad \therefore RTBP_{i,h}(p) > RTLMP_{i,m,h,k} \end{array} \right\} \therefore m \in RTD \end{array} \right\} \therefore i \in S_{NGR}$$

RTLED and RTUED are either both equal to the Energy Bid breakpoint where the bid price jumps over the RTLMP, including the RTLEL or RTUEL, or equal to the start and end, respectively, of the Energy Bid segment with a bid price equal to the RTLMP when the resource is marginal. RTLED and RTUED are both equal to the Pumping Level for pumping mode. Also it is important to note that, when there is no Real-Time Energy Bid,

$$\left\{ \begin{array}{l} RTLED_{i,m,h,f} = RTUED_{i,m,h,f} = \max(RTSS_{i,h}, P_{MINi}) \quad \therefore i \in S_{GEN} \cup S_{TIE} \end{array} \right\} \therefore m \in FMM$$

$$\left\{ \begin{array}{l} RTLED_{i,m,h,k} = RTUED_{i,m,h,k} = \max(RTSS_{i,h}, P_{MINi}) \quad \therefore i \in S_{GEN} \cup S_{TIE} \end{array} \right\} \therefore m \in RTD$$

$$\left\{ \begin{array}{l} RTLED_{i,m,h,f} = RTUED_{i,m,h,f} = \begin{cases} \max(RTTGSS_{i,h}, G_{MINi}) & \therefore RTTGSS_{i,h} > 0 \\ \min(RTTLSS_{i,h}, L_{MINi}) & \therefore RTTLSS_{i,h} < 0 \\ 0 & \therefore RTTGSS_{i,h} = RTTLSS_{i,h} = 0 \end{cases} \end{array} \right\} \therefore i \in S_{NGR} \left. \vphantom{\left\{ \begin{array}{l} RTLED_{i,m,h,f} = RTUED_{i,m,h,f} = \begin{cases} \max(RTTGSS_{i,h}, G_{MINi}) & \therefore RTTGSS_{i,h} > 0 \\ \min(RTTLSS_{i,h}, L_{MINi}) & \therefore RTTLSS_{i,h} < 0 \\ 0 & \therefore RTTGSS_{i,h} = RTTLSS_{i,h} = 0 \end{cases} \end{array} \right\}} \right\} \therefore m \in \{FMM\}$$

$$\left\{ \begin{array}{l} RTLED_{i,m,h,k} = RTUED_{i,m,h,k} = \begin{cases} \max(RTTGSS_{i,h}, G_{MINi}) & \therefore RTTGSS_{i,h} > 0 \\ \min(RTTLSS_{i,h}, L_{MINi}) & \therefore RTTLSS_{i,h} < 0 \\ 0 & \therefore RTTGSS_{i,h} = RTTLSS_{i,h} = 0 \end{cases} \end{array} \right\} \therefore i \in S_{NGR} \left. \vphantom{\left\{ \begin{array}{l} RTLED_{i,m,h,k} = RTUED_{i,m,h,k} = \begin{cases} \max(RTTGSS_{i,h}, G_{MINi}) & \therefore RTTGSS_{i,h} > 0 \\ \min(RTTLSS_{i,h}, L_{MINi}) & \therefore RTTLSS_{i,h} < 0 \\ 0 & \therefore RTTGSS_{i,h} = RTTLSS_{i,h} = 0 \end{cases} \end{array} \right\}} \right\} \therefore m \in RTD$$

In general, RTLED and RTUED may differ in each Dispatch Interval. For the following sections, it is convenient to define the following functions:

$$\left. \begin{array}{l} RTLED_{i,m,h}(t) \equiv RTLED_{i,m,h,f} \\ RTUED_{i,m,h}(t) \equiv RTUED_{i,m,h,f} \end{array} \right\} \therefore T_{h,f-1} \leq t < T_{h,f}, \quad f = 1, 2, \dots, 4 \left. \vphantom{\begin{array}{l} RTLED_{i,m,h}(t) \equiv RTLED_{i,m,h,f} \\ RTUED_{i,m,h}(t) \equiv RTUED_{i,m,h,f} \end{array}} \right\} \therefore m \in FMM$$

$$\left. \begin{array}{l} RTLED_{i,m,h}(t) \equiv RTLED_{i,m,h,k} \\ RTUED_{i,m,h}(t) \equiv RTUED_{i,m,h,k} \end{array} \right\} \therefore T_{h,k-1} \leq t < T_{h,k}, \quad k = 1, 2, \dots, 12 \left. \vphantom{\begin{array}{l} RTLED_{i,m,h}(t) \equiv RTLED_{i,m,h,k} \\ RTUED_{i,m,h}(t) \equiv RTUED_{i,m,h,k} \end{array}} \right\} \therefore m \in RTD$$

Extra-Marginal Energy is calculated separately for each relevant Instructed Imbalance Energy subtype, as shown in the following sections.

#### C.2.1.14 Binding Exceptional Dispatch

There could be multiple Exceptional Dispatch Instructions active in a given Dispatch Interval. Nevertheless, only one at most can be binding, determined as follows:

$$\left\{ \begin{array}{l}
 ED_{BNDi,m,h,f} = \begin{cases} \max(ED_{FIXi,m,h,f}, ED_{MINi,m,h,f,j}) & \because ED_{FIXi,m,h,f}, ED_{MINi,m,h,f,j} > RTUED_{i,m,h,f} \\
 \min(ED_{FIXi,m,h,f}, ED_{MAXi,m,h,f,j}) & \because ED_{FIXi,m,h,f}, ED_{MAXi,m,h,f,j} < RTLED_{i,m,h,f} \\
 NULL & \text{otherwise} \end{cases} & \because m \in \text{FMM} \\
 \\
 ED_{BNDi,m,h,k} = \begin{cases} \max(ED_{FIXi,m,h,k}, ED_{MINi,m,h,k,j}) & \because ED_{FIXi,m,h,k}, ED_{MINi,m,h,k,j} > RTUED_{i,m,h,k} \\
 \min(ED_{FIXi,m,h,k}, ED_{MAXi,m,h,k,j}) & \because ED_{FIXi,m,h,k}, ED_{MAXi,m,h,k,j} < RTLED_{i,m,h,k} \\
 NULL & \text{otherwise} \end{cases} & \because m \in \text{RTD}
 \end{array} \right.$$

Considering any point in the unconstrained Economic Dispatch range as the Binding Exceptional Dispatch by default when one does not exist, is an algorithmic mechanism to render it irrelevant in the equations without checking for its existence.

It is assumed that Exceptional Dispatch instructions cannot conflict; therefore, a Fixed Exceptional Dispatch cannot coexist with other Fixed Exceptional Dispatches, a higher Min Exceptional Dispatch, or a lower Max Exceptional Dispatch; moreover, a Min Exceptional Dispatch cannot be higher than a Max Exceptional Dispatch.

In general, the Binding Exceptional Dispatch may differ in each Dispatch Interval. For the following sections, it is convenient to define the following function:

$$\left\{ \begin{array}{l}
 ED_{BNDi,m,h}(t) \equiv ED_{BNDi,m,h,f} \quad \because T_{h,f-1} \leq t < T_{h,f}, \quad f = 1, 2, \dots, 4 \quad \because m \in \text{FMM} \\
 \\
 ED_{BNDi,m,h}(t) \equiv ED_{BNDi,m,h,k} \quad \because T_{h,k-1} \leq t < T_{h,k}, \quad k = 1, 2, \dots, 12 \quad \because m \in \text{RTD}
 \end{array} \right.$$

The binding Exceptional Dispatch Instruction in a given Dispatch Interval (5-minute for market type  $m = \text{RTD}$  or 15-minute for market type  $m = \text{RTPD}$ ) is extended to subsequent and previous Dispatch Intervals without a binding Exceptional Dispatch Instruction while the Dispatch Operating Point ramps from/to the binding Exceptional Dispatch instruction to/from

*RTUED/RTLED* for RTD market or FMS approaches the binding Exceptional Dispatch Instruction to/from *RTUED/RTLED* for RTPD market, as follows:

$$\left\{ \begin{array}{l} ED_{BNDi,m,h}(t) = ED_{BNDi,m,h,f} \quad \therefore T_{h,f} \leq t \leq TF_{ED} \quad \therefore m \in FMM \\ ED_{BNDi,m,h}(t) = ED_{BNDi,m,h,k} \quad \therefore T_{h,k} \leq t \leq TF_{ED} \quad \therefore m \in RTD \end{array} \right.$$

$$\left\{ \begin{array}{l} ED_{BNDi,m,h}(t) = ED_{BNDi,m,h,f} \quad \therefore T_{h,f-1} > t \geq TB_{ED} \quad \therefore m \in FMM \\ ED_{BNDi,m,h}(t) = ED_{BNDi,m,h,k} \quad \therefore T_{h,k-1} > t \geq TB_{ED} \quad \therefore m \in RTD \end{array} \right.$$

Where the forward and backward Exceptional Dispatch instruction extension time limits are calculated as follows:

$$TF_{ED,m} = \left\{ \begin{array}{l} \max \left[ \max T \quad \therefore \left\{ \begin{array}{l} ED_{BNDi,m,h}(t) = NULL \\ s_{i,m}(t) = -1 \\ FMS_{i,h,f} > RTUED_{i,m,h}(t) + TOL \end{array} \right\}, \max T \quad \therefore \left\{ \begin{array}{l} ED_{BNDi,m,h}(t) = NULL \\ s_{i,m}(t) = 1 \\ FMS_{i,h,f} < RTLED_{i,m,h}(t) - TOL \end{array} \right\} \right] \quad \therefore T_{h,f} \leq t \leq T \leq T_N \quad \therefore m \in FMM \\ \max \left[ \max T \quad \therefore \left\{ \begin{array}{l} ED_{BNDi,m,h}(t) = NULL \\ s_{i,m}(t) = -1 \\ DOP_i(t) > RTUED_{i,m,h}(t) + TOL \end{array} \right\}, \max T \quad \therefore \left\{ \begin{array}{l} ED_{BNDi,m,h}(t) = NULL \\ s_{i,m}(t) = 1 \\ DOP_i(t) < RTLED_{i,m,h}(t) - TOL \end{array} \right\} \right] \quad \therefore T_{h,k} \leq t \leq T \leq T_N \quad \therefore m \in RTD \end{array} \right.$$

$$TB_{ED,m} = \left\{ \begin{array}{l} \min \left[ \min T \quad \therefore \left\{ \begin{array}{l} ED_{BNDi,m,h}(t) = NULL \\ s_{i,m}(t) = 1 \\ FMS_{i,h,f} > RTUED_{i,m,h}(t) + TOL \end{array} \right\}, \min T \quad \therefore \left\{ \begin{array}{l} ED_{BNDi,m,h}(t) = NULL \\ s_{i,m}(t) = -1 \\ FMS_{i,h,f} < RTLED_{i,m,h}(t) - TOL \end{array} \right\} \right] \quad \therefore T_{h,f-1} \geq t \geq T \geq T_0 \quad \therefore m \in FMM \\ \min \left[ \min T \quad \therefore \left\{ \begin{array}{l} ED_{BNDi,m,h}(t) = NULL \\ s_{i,m}(t) = 1 \\ DOP_i(t) > RTUED_{i,m,h}(t) + TOL \end{array} \right\}, \min T \quad \therefore \left\{ \begin{array}{l} ED_{BNDi,m,h}(t) = NULL \\ s_i(t) = -1 \\ DOP_i(t) < RTLED_{i,m,h}(t) - TOL \end{array} \right\} \right] \quad \therefore T_{h,k-1} \geq t \geq T \geq T_0 \quad \therefore m \in RTD \end{array} \right.$$

If the search reaches the end or start of the target Trading Day, it shall continue into subsequent or previous Trading Days as needed.

To complete the Exceptional Dispatch function, any remaining *NULL* sections are replaced after extensions as follows:

$$ED_{BNDi,m,h}(t) \leftarrow \frac{RTLED_{i,m,h}(t) + RTUED_{i,m,h}(t)}{2} \quad \therefore ED_{BNDi,m,h}(t) = NULL \quad \therefore m \in \{RTPD, RTD\}$$

Considering any point in the unconstrained economic dispatch range as the binding Exceptional Dispatch by default when one does not exist, is an algorithmic mechanism to render it irrelevant in the equations without checking for its existence.

### C.2.1.15 Operating Limits

For the following sections, it is convenient to define the following operating limit functions:

$$\left. \begin{array}{l} RTUOL_{i,m,h}(t) \equiv RTUOL_{i,m,h,f} \\ RTLOL_{i,m,h}(t) \equiv RTLOL_{i,m,h,f} \end{array} \right\} \therefore T_{h,f-1} \leq t < T_{h,f}, \quad f = 1, 2, \dots, 4, i \in S_{GEN} \cup S_{TIE} \rangle \therefore m \in FMM$$

$$\left. \begin{array}{l} RTUOL_{i,m,h}(t) \equiv RTUOL_{i,m,h,k} \\ RTLOL_{i,m,h}(t) \equiv RTLOL_{i,m,h,k} \end{array} \right\} \therefore T_{h,k-1} \leq t < T_{h,k}, \quad k = 1, 2, \dots, 12, i \in S_{GEN} \cup S_{TIE} \rangle \therefore m \in RTD$$

$$\left. \begin{array}{l} GRTUOL_{i,m,h}(t) \equiv GRTUOL_{i,m,h,f} \\ GRTLLOL_{i,m,h}(t) \equiv GRTLLOL_{i,m,h,f} \end{array} \right\} \therefore T_{h,f-1} \leq t < T_{h,f}, \quad f = 1, 2, \dots, 4, i \in S_{NGR} \rangle \therefore m \in FMM$$

$$\left. \begin{array}{l} GRTUOL_{i,m,h}(t) \equiv GRTUOL_{i,m,h,k} \\ GRTLLOL_{i,m,h}(t) \equiv GRTLLOL_{i,m,h,k} \end{array} \right\} \therefore T_{h,k-1} \leq t < T_{h,k}, \quad k = 1, 2, \dots, 12, i \in S_{NGR} \rangle \therefore m \in RTD$$

$$\left. \begin{array}{l} LRTUOL_{i,m,h}(t) \equiv LRTUOL_{i,m,h,f} \\ LRTLLOL_{i,m,h}(t) \equiv LRTLLOL_{i,m,h,f} \end{array} \right\} \therefore T_{h,f-1} \leq t < T_{h,f}, \quad f = 1, 2, \dots, 4, i \in S_{NGR} \rangle \therefore m \in FMM$$

$$\left. \begin{array}{l} LRTUOL_{i,m,h}(t) \equiv LRTUOL_{i,m,h,k} \\ LRTLLOL_{i,m,h}(t) \equiv LRTLLOL_{i,m,h,k} \end{array} \right\} \therefore T_{h,k-1} \leq t < T_{h,k}, \quad k = 1, 2, \dots, 12, i \in S_{NGR} \rangle \therefore m \in RTD$$

An overrated operating limit in a given Dispatch Interval is extended to subsequent and previous Dispatch Intervals while the Dispatch Operating Point ramps from/to that overrated operating limit to/from *RTUED/RTLED*, as follows:

$$\left. \begin{array}{l} RTLOL_{i,m,h}(t) \leftarrow RTLOL_{i,m,h,f} \quad \therefore T_{h,f} \leq t \leq TF_{LOL,m} \end{array} \right\} \therefore m \in FMM$$

$$\left. \begin{array}{l} RTLOL_{i,m,h}(t) \leftarrow RTLOL_{i,m,h,k} \quad \therefore T_{h,k} \leq t \leq TF_{LOL,m} \end{array} \right\} \therefore m \in RTD$$

$$\left\{ \begin{array}{l} RTLOL_{i,m,h}(t) \leftarrow RTLOL_{i,m,h,f} \quad \therefore T_{h,f-1} > t \geq TB_{LOL,m} \rangle \therefore m \in FMM \\ RTLOL_{i,m,h}(t) \leftarrow RTLOL_{i,m,h,k} \quad \therefore T_{h,k-1} > t \geq TB_{LOL,m} \rangle \therefore m \in RTD \end{array} \right.$$

$$\left\{ \begin{array}{l} GRTLOL_{i,m,h}(t) \leftarrow GRTLOL_{i,m,h,f} \quad \therefore T_{h,f} \leq t \leq TF_{GLOL,m} \rangle \therefore m \in FMM \\ GRTLOL_{i,m,h}(t) \leftarrow GRTLOL_{i,m,h,k} \quad \therefore T_{h,k} \leq t \leq TF_{GLOL,m} \rangle \therefore m \in RTD \end{array} \right.$$

$$\left\{ \begin{array}{l} GRTLOL_{i,m,h}(t) \leftarrow GRTLOL_{i,m,h,f} \quad \therefore T_{h,f-1} > t \geq TB_{GLOL,m} \rangle \therefore m \in FMM \\ GRTLOL_{i,m,h}(t) \leftarrow GRTLOL_{i,m,h,k} \quad \therefore T_{h,k-1} > t \geq TB_{GLOL,m} \rangle \therefore m \in RTD \end{array} \right.$$

$$\left\{ \begin{array}{l} LRTLOL_{i,m,h}(t) \leftarrow LRTLOL_{i,m,h,f} \quad \therefore T_{h,f} \leq t \leq TF_{LLOL,m} \rangle \therefore m \in FMM \\ LRTLOL_{i,m,h}(t) \leftarrow LRTLOL_{i,m,h,k} \quad \therefore T_{h,k} \leq t \leq TF_{LLOL,m} \rangle \therefore m \in RTD \end{array} \right.$$

$$\left\{ \begin{array}{l} LRTLOL_{i,m,h}(t) \leftarrow LRTLOL_{i,m,h,f} \quad \therefore T_{h,f-1} > t \geq TB_{LLOL,m} \rangle \therefore m \in FMM \\ LRTLOL_{i,m,h}(t) \leftarrow LRTLOL_{i,m,h,k} \quad \therefore T_{h,k-1} > t \geq TB_{LLOL,m} \rangle \therefore m \in RTD \end{array} \right.$$

Where the forward and backward overrated lower operating limit extension time limits are calculated as follows:



$$TF_{LOL,m} = \begin{cases} \max T \quad \therefore \left\{ \begin{array}{l} RTLOL_{i,m,h,f} > P_{MINi} \\ s_{i,m}(t) = -1 \\ FMS_{i,h,f} > RTUED_{i,m,h}(t) + TOL \end{array} \right\} & \therefore T_{h,f} \leq t \leq T \leq T_N \quad \therefore m \in FMM \\ \max T \quad \therefore \left\{ \begin{array}{l} RTLOL_{i,m,h,k} > P_{MINi} \\ s_{i,m}(t) = -1 \\ DOP_i(t) > RTUED_{i,m,h}(t) + TOL \end{array} \right\} & \therefore T_{h,k} \leq t \leq T \leq T_N \quad \therefore m \in RTD \end{cases}$$

$$TB_{LOL,m} = \begin{cases} \min T \quad \therefore \left\{ \begin{array}{l} RTLOL_{i,m,h,f} > P_{MINi} \\ s_{i,m}(t) = 1 \\ FMS_{i,h,f} > RTUED_{i,m,h}(t) + TOL \end{array} \right\} & \therefore T_{h,f-1} \geq t \geq T \geq T_0 \quad \therefore m \in FMM \\ \min T \quad \therefore \left\{ \begin{array}{l} RTLOL_{i,m,h,k} > P_{MINi} \\ s_{i,m}(t) = 1 \\ DOP_i(t) > RTUED_{i,m,h}(t) + TOL \end{array} \right\} & \therefore T_{h,k-1} \geq t \geq T \geq T_0 \quad \therefore m \in RTD \end{cases}$$

$$TF_{GLOL,m} = \begin{cases} \max T \quad \therefore \left\{ \begin{array}{l} GRTLOL_{i,m,h,f} > G_{MINi} \\ s_{i,m}(t) = -1 \\ FMS_{i,h,f} > RTUED_{i,m,h}(t) + TOL \end{array} \right\} & \therefore T_{h,f} \leq t \leq T \leq T_N \quad \therefore m \in FMM \\ \max T \quad \therefore \left\{ \begin{array}{l} GRTLOL_{i,m,h,k} > G_{MINi} \\ s_{i,m}(t) = -1 \\ DOP_i(t) > RTUED_{i,m,h}(t) + TOL \end{array} \right\} & \therefore T_{h,k} \leq t \leq T \leq T_N \quad \therefore m \in RTD \end{cases}$$

$$TB_{GLOL,m} = \begin{cases} \min T \quad \therefore \left\{ \begin{array}{l} GRTLOL_{i,m,h,f} > G_{MINi} \\ s_{i,m}(t) = 1 \\ FMS_{i,h,f} > RTUED_{i,m,h}(t) + TOL \end{array} \right\} & \therefore T_{h,f-1} \geq t \geq T \geq T_0 \quad \therefore m \in FMM \\ \min T \quad \therefore \left\{ \begin{array}{l} GRTLOL_{i,m,h,k} > G_{MINi} \\ s_{i,m}(t) = 1 \\ DOP_i(t) > RTUED_{i,m,h}(t) + TOL \end{array} \right\} & \therefore T_{h,k-1} \geq t \geq T \geq T_0 \quad \therefore m \in RTD \end{cases}$$

$$TF_{LLOL,m} = \begin{cases} \max T \quad \therefore \left\{ \begin{array}{l} LRTLOL_{i,m,h,f} < L_{MINi} \\ s_{i,m}(t) = 1 \\ FMS_{i,h,f} < RTLED_{i,m,h}(t) - TOL \end{array} \right\} & \therefore T_{h,f} \leq t \leq T \leq T_N \quad \therefore m \in FMM \\ \max T \quad \therefore \left\{ \begin{array}{l} LRTLOL_{i,m,h,k} < L_{MINi} \\ s_{i,m}(t) = 1 \\ DOP_i(t) < RTLED_{i,m,h}(t) - TOL \end{array} \right\} & \therefore T_{h,k} \leq t \leq T \leq T_N \quad \therefore m \in RTD \end{cases}$$

$$TB_{LLOL,m} = \begin{cases} \min T \quad \therefore \left\{ \begin{array}{l} LRTLOL_{i,m,h,f} < L_{MINi} \\ s_{i,m}(t) = -1 \\ FMS_{i,h,f} < RTLED_{i,m,h}(t) - TOL \end{array} \right\} & \therefore T_{h,f-1} \geq t \geq T \geq T_0 \quad \therefore m \in FMM \\ \min T \quad \therefore \left\{ \begin{array}{l} LRTLOL_{i,m,h,k} < L_{MINi} \\ s_{i,m}(t) = -1 \\ DOP_i(t) < RTLED_{i,m,h}(t) - TOL \end{array} \right\} & \therefore T_{h,k-1} \geq t \geq T \geq T_0 \quad \therefore m \in RTD \end{cases}$$

If the search reaches the end or start of the target Trading Day, it shall continue into subsequent or previous Trading Days as needed.

### C.2.1.16 Slope Direction

For the RTD market, the Slope Direction of the Dispatch Operating Point function is the sign of its first derivative as follows:

$$s_m(t) \equiv \text{signum}\left(\frac{dDOP(t)}{dt}\right) = \left\{ \begin{array}{ll} -1 & \text{decreasing} \\ 0 & \text{flat} \\ 1 & \text{increasing} \end{array} \right\} \therefore m \in RTD$$

For the RTD market, the Dispatch Operating Point may be discontinuous at the midpoint of each Dispatch Interval because of “vertical” corrections due to the “projected” State Estimator solution. The Slope Direction may change at these points, however, it remains constant for the first half and the second half of the Dispatch Interval. Note that the slope itself may change within these halves because of ramp rate changes; however, the slope direction does not change. Therefore, the Dispatch Operating Point Slope Direction can also be determined as follows:

$$s_{i,m,h,k}(t) \equiv \left\{ \begin{array}{l} -1 \quad \because DOP_i(T_{h,k-1}) > DOP_i\left(\frac{T_{h,k-1} + T_{h,k}}{2}\right) \\ 0 \quad \because DOP_i(T_{h,k-1}) = DOP_i\left(\frac{T_{h,k-1} + T_{h,k}}{2}\right) \\ 1 \quad \because DOP_i(T_{h,k-1}) < DOP_i\left(\frac{T_{h,k-1} + T_{h,k}}{2}\right) \end{array} \right\} \begin{array}{l} \therefore T_{h,k-1} \leq t < \frac{T_{h,k-1} + T_{h,k}}{2} \\ \\ \\ \\ \end{array} \left. \vphantom{\left\{ \begin{array}{l} -1 \\ 0 \\ 1 \end{array} \right\}} \right\} \therefore m \in RTD$$

$$\left\{ \begin{array}{l} -1 \quad \because DOP_i\left(\frac{T_{h,k-1} + T_{h,k}}{2}\right) > DOP_i(T_{h,k}) \\ 0 \quad \because DOP_i\left(\frac{T_{h,k-1} + T_{h,k}}{2}\right) = DOP_i(T_{h,k}) \\ 1 \quad \because DOP_i\left(\frac{T_{h,k-1} + T_{h,k}}{2}\right) < DOP_i(T_{h,k}) \end{array} \right\} \begin{array}{l} \therefore \frac{T_{h,k-1} + T_{h,k}}{2} < t \leq T_{h,k} \\ \\ \\ \\ \end{array}$$

For the FMM, a Ramping Fifteen Minute Schedule (RFMS) is defined as the continuous piecewise linear curve connecting consecutive *FMS*'s using their mid-interval points, i.e. dispatch results from FMM runs. The Slope Direction of the Ramping Fifteen Minute Schedule (RFMS) function is the sign of its first derivative as follows:

$$s_m(t) \equiv \text{signum}\left(\frac{dRFMS(t)}{dt}\right) = \left\{ \begin{array}{l} -1 \quad \text{decreasing} \\ 0 \quad \text{flat} \\ 1 \quad \text{increasing} \end{array} \right\} \therefore m \in FMM$$

For the FMM, the Ramping Fifteen Minute Schedule (RFMS) may change at the midpoint of each 15-minute Dispatch Interval because of FMS change direction. The Slope Direction may change at these points, however, it remains constant for the first half and the second half of the 15-minute Dispatch Interval. The Dispatch Operating Point Slope Direction can also be determined as follows:

$$s_{i,m,h,f}(t) \equiv \left\{ \begin{array}{l} -1 \quad \because FMS_i(T_{h,f-1}) > FMS_i(T_{h,f}) \\ 0 \quad \because FMS_i(T_{h,f-1}) = FMS_i(T_{h,f}) \\ 1 \quad \because FMS_i(T_{h,f-1}) < FMS_i(T_{h,f}) \end{array} \right\} \quad \because T_{h,f-1} \leq t < \frac{T_{h,f-1} + T_{h,f}}{2}$$

$$\left\{ \begin{array}{l} -1 \quad \because FMS_i(T_{h,f}) > FMS_i(T_{h,f+1}) \\ 0 \quad \because FMS_i(T_{h,f}) = FMS_i(T_{h,f+1}) \\ 1 \quad \because FMS_i(T_{h,f}) < FMS_i(T_{h,f+1}) \end{array} \right\} \quad \because \frac{T_{h,f-1} + T_{h,f}}{2} < t \leq T_{h,f}$$

$$\left. \vphantom{\begin{array}{l} -1 \\ 0 \\ 1 \end{array}} \right\} \because m \in FMM$$

### C.2.1.17 Instructed Imbalance Energy Stack

Figure 5 illustrates how the various Instructed Imbalance Energy subtypes stack.

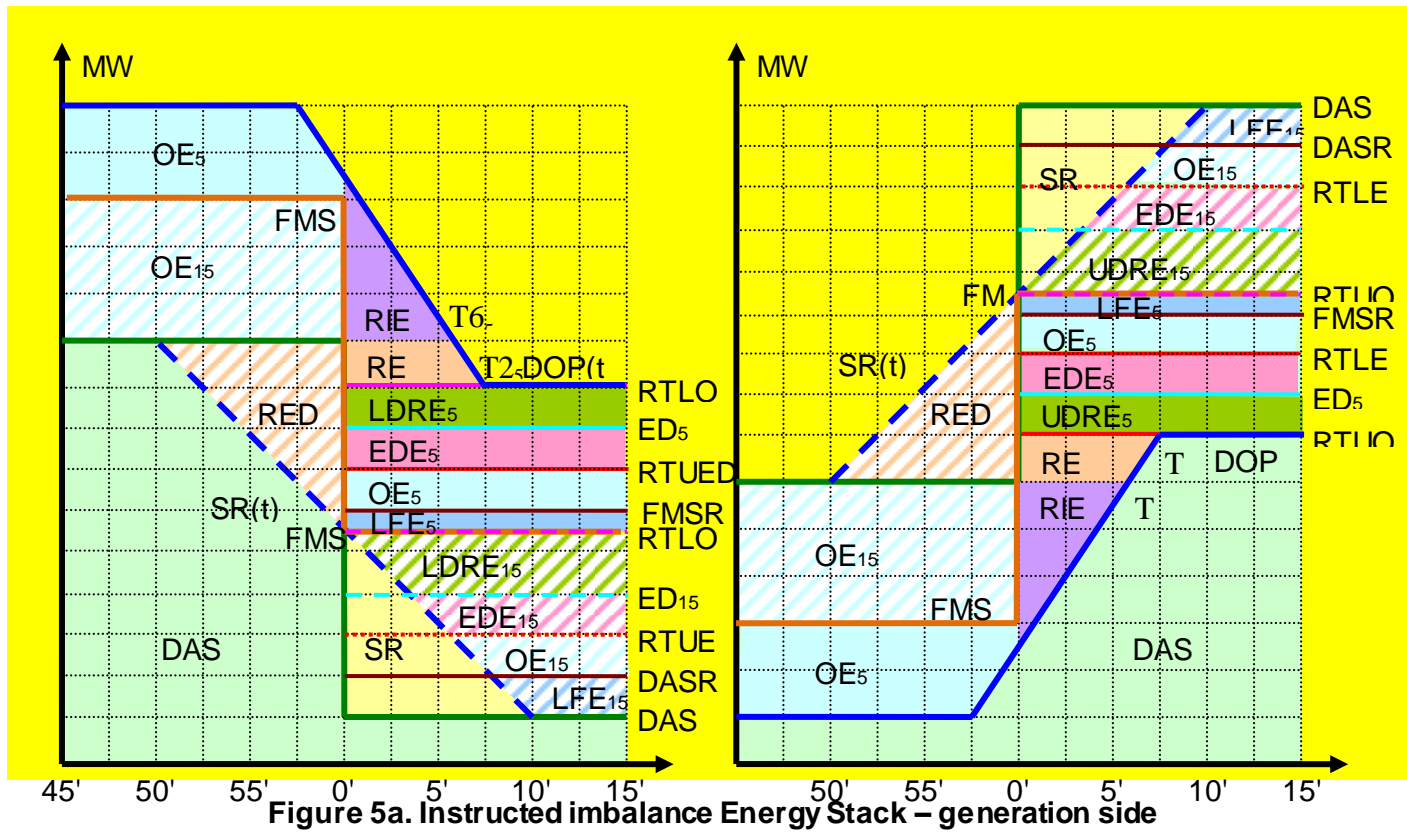
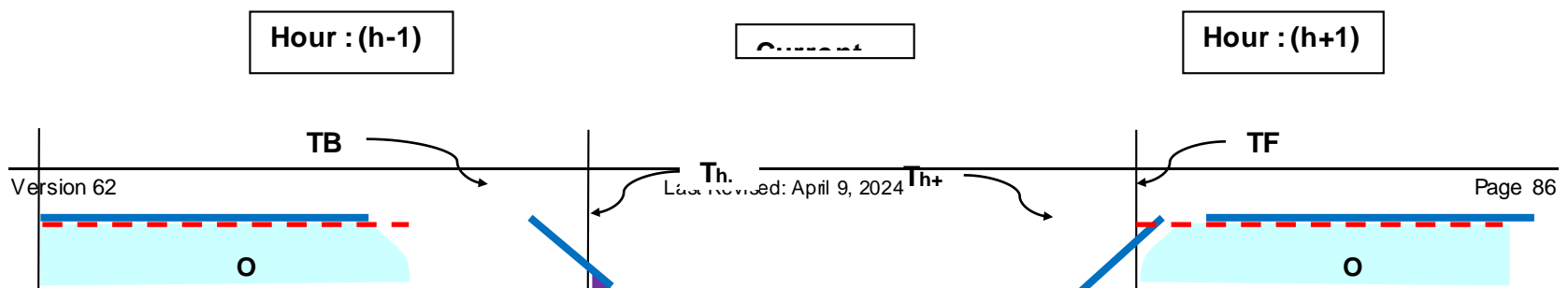

Figure 5a. Instructed imbalance Energy Stack – generation side

$$i \in S_{GEN} \cup S_{NGR}$$



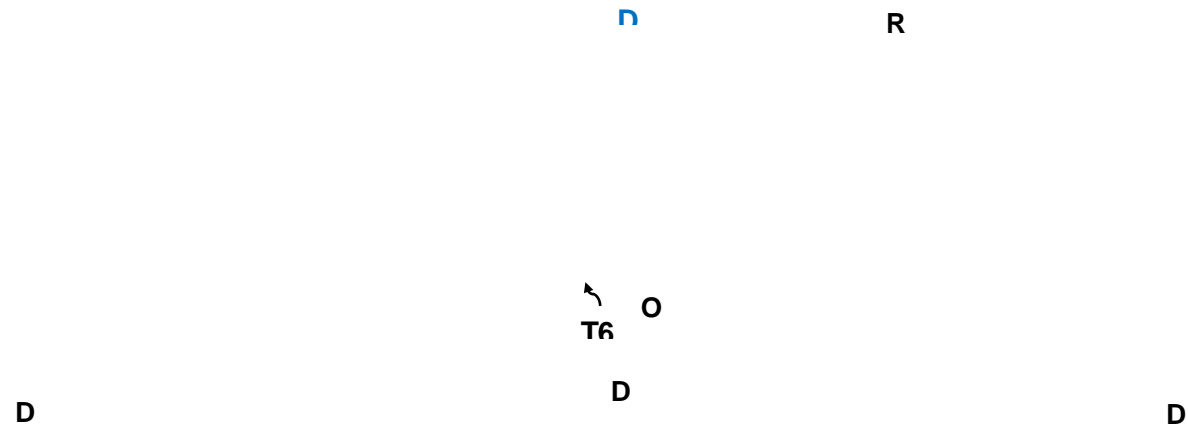
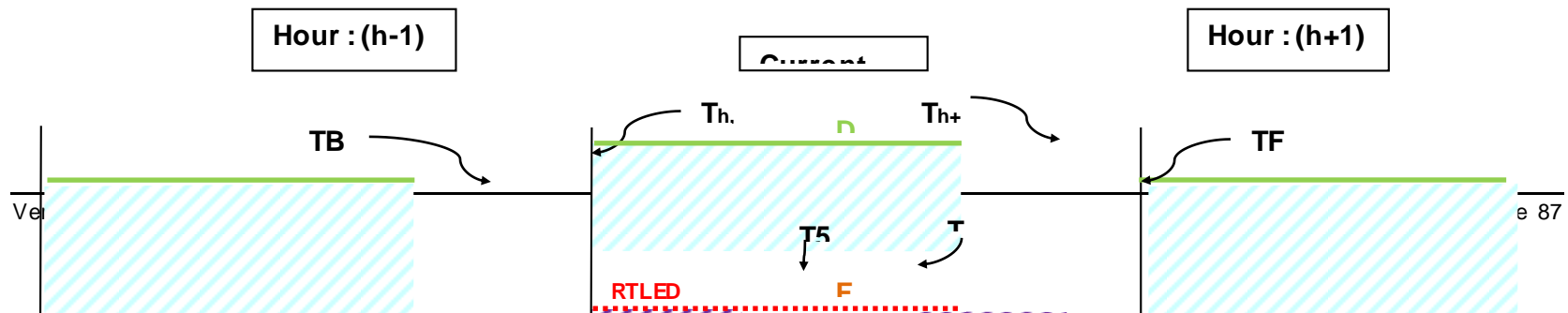

Figure 5b Instructed Imbalance Energy Stack for Incremental Residual Energy for a Generating Resource.

$$i \in S_{GEN} \cup S_{NGR}$$



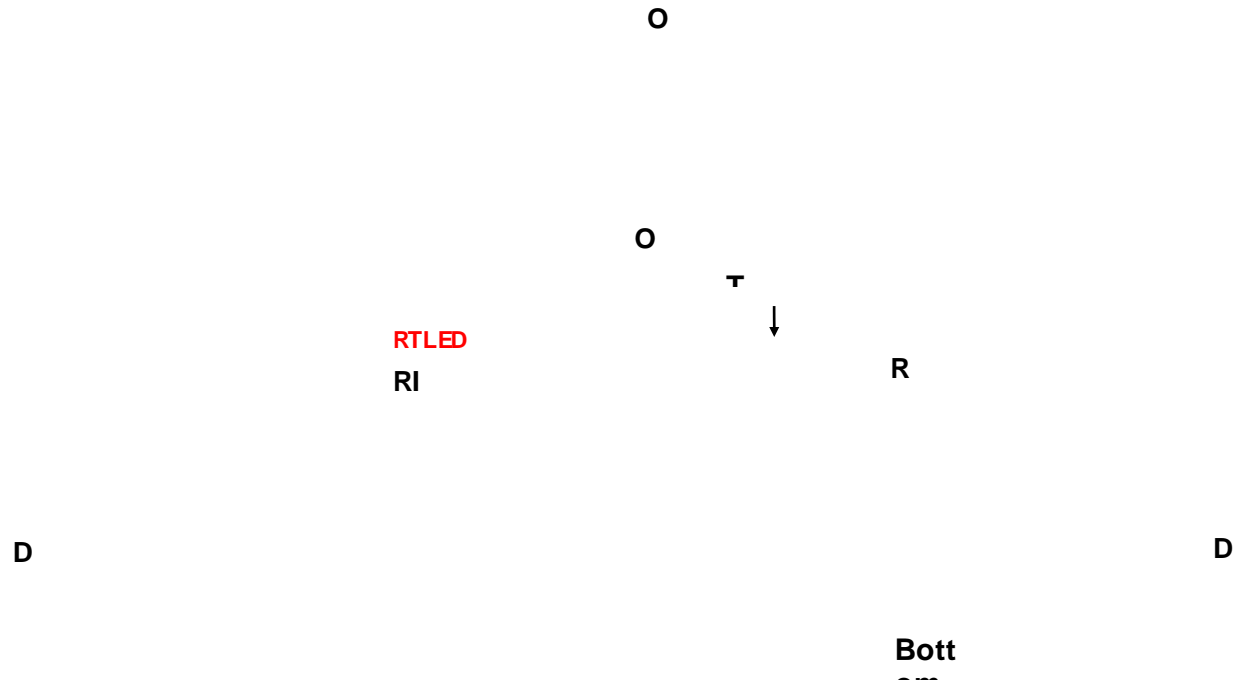
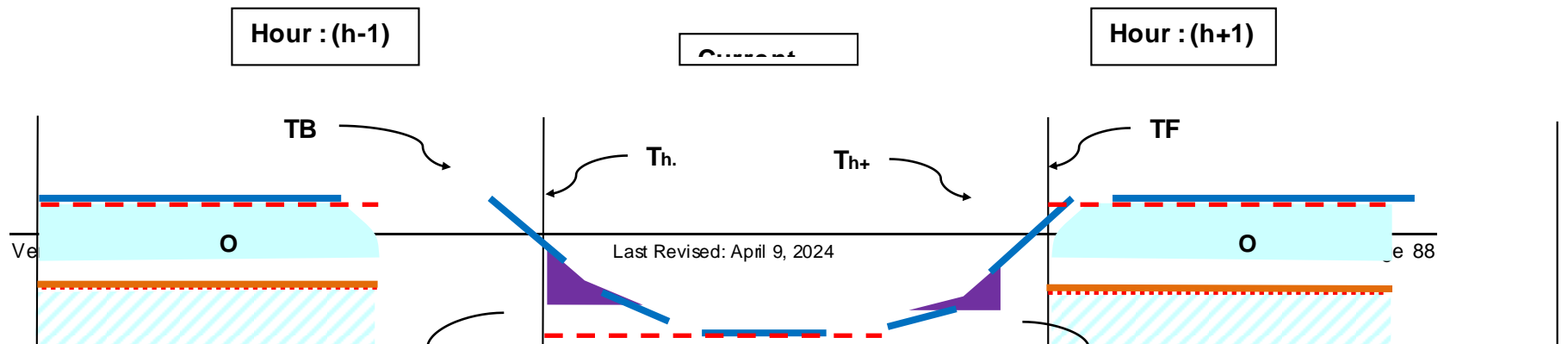
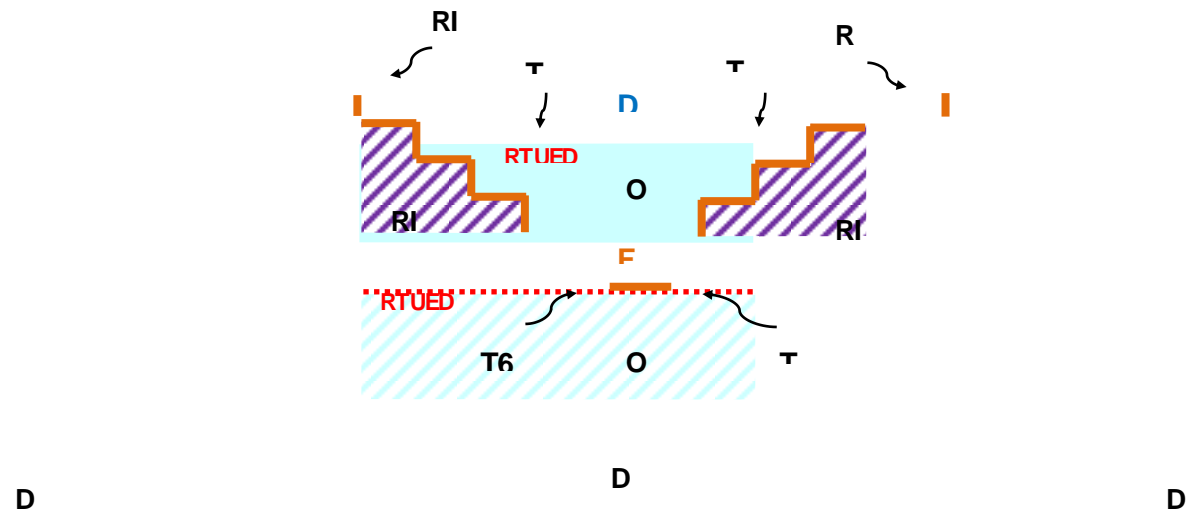

Figure 5c Instructed Imbalance Energy Stack for Decremental Residual Energy for a Generating Resource

$$i \in S_{GEN} \cup S_{NGR}$$

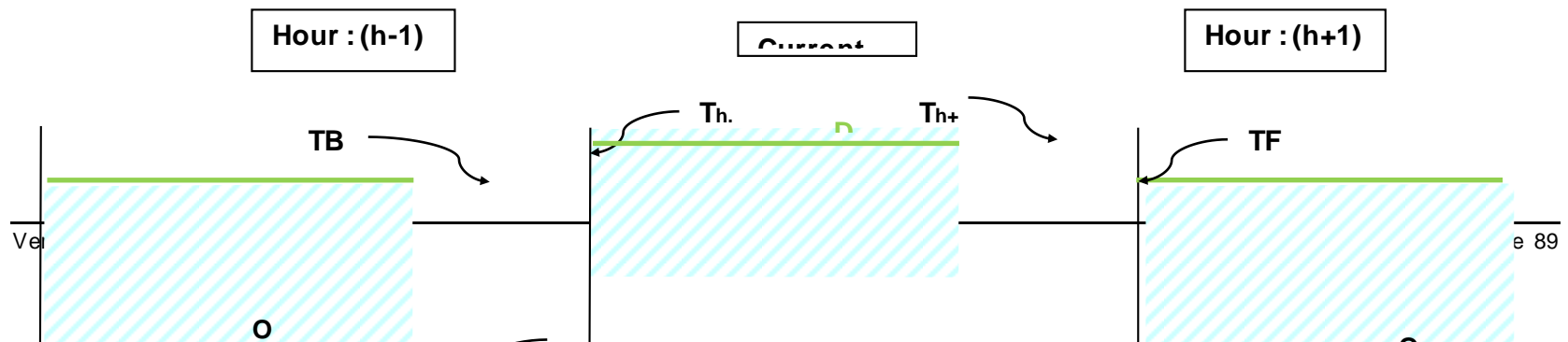

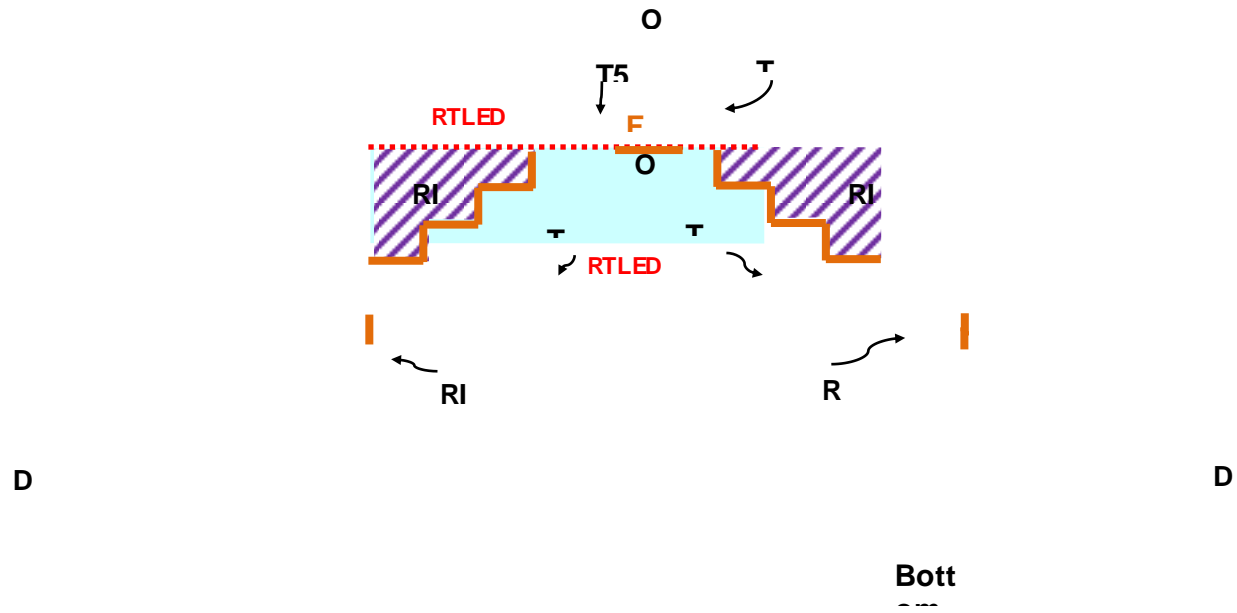



**Figure 5d Instructed Imbalance Energy Stack for Incremental Residual Energy for a Generating Resource (RIE Overlapping Case)**

$$i \in S_{GEN} \cup S_{NGR}$$





**Figure 5e Instructed Imbalance Energy Stack for Decremental Residual Energy for a Generating Resource (RIE Overlapping Case)**

$$i \in S_{GEN} \cup S_{NGR}$$

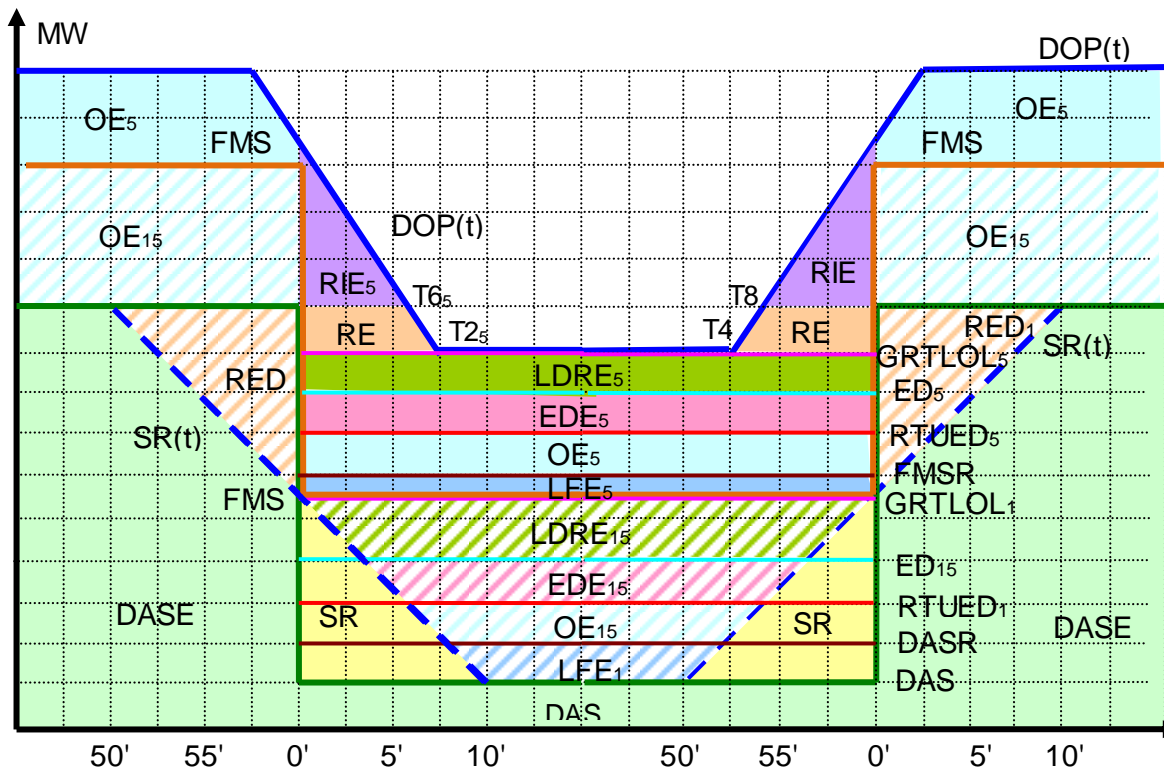

Figure 5f Instructed Imbalance Energy Stack for a NGR. Generation side, RTD dispatch greater than DA schedule.

$$i \in S_{NGR}$$

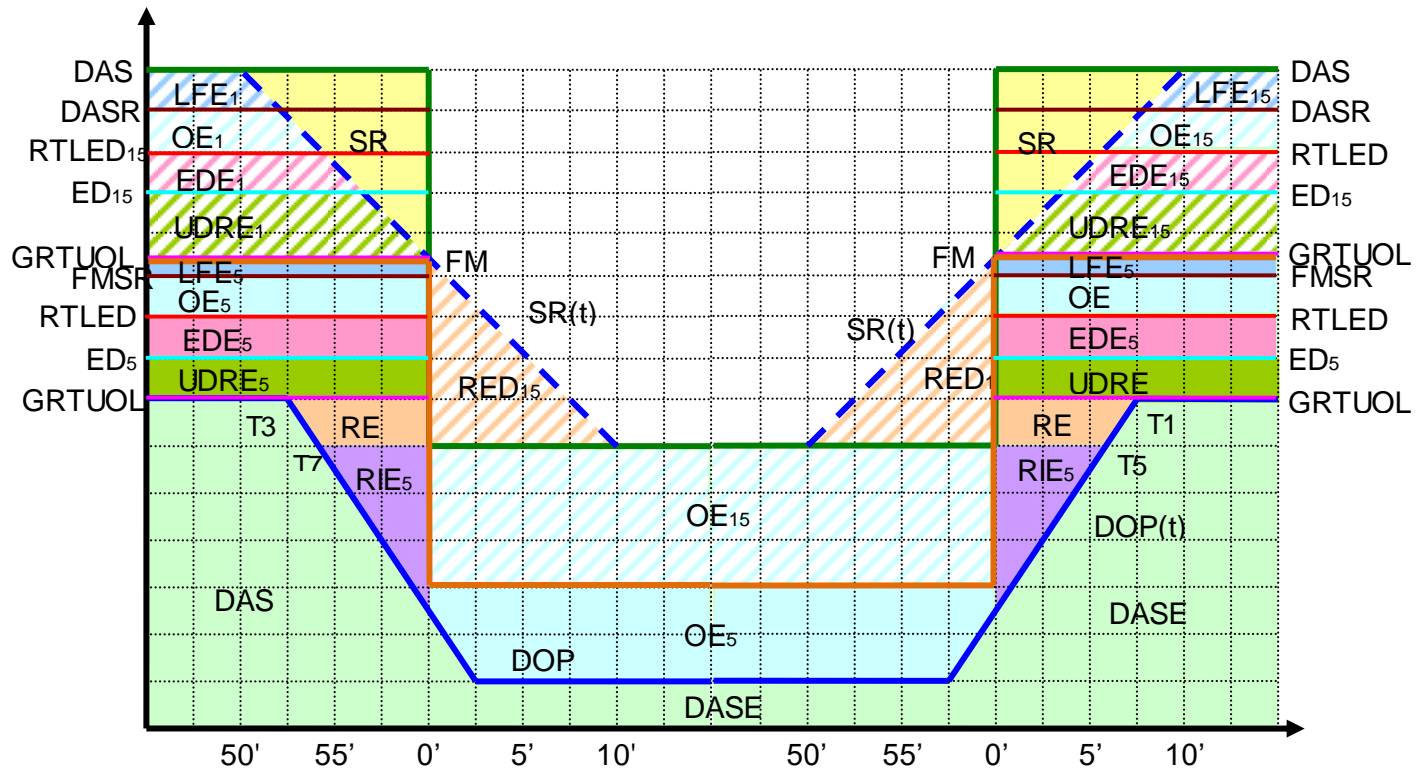

Figure 5g Instructed Imbalance Energy Stack for a NGR. Generation side, RTD dispatch less than DA schedule.

$$i \in S_{NGR}$$

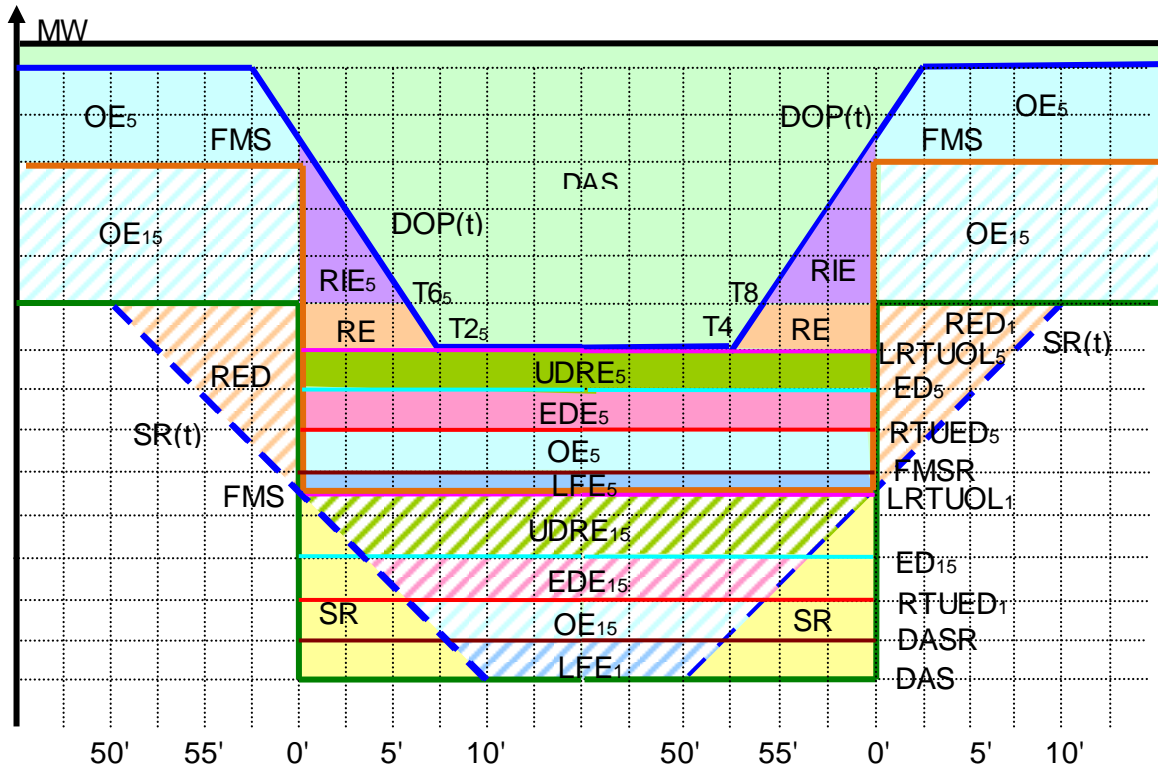

Figure 5h Instructed Imbalance Energy Stack for a NGR. Load side, RTD dispatch greater than DA schedule.

$$i \in S_{NGR}$$

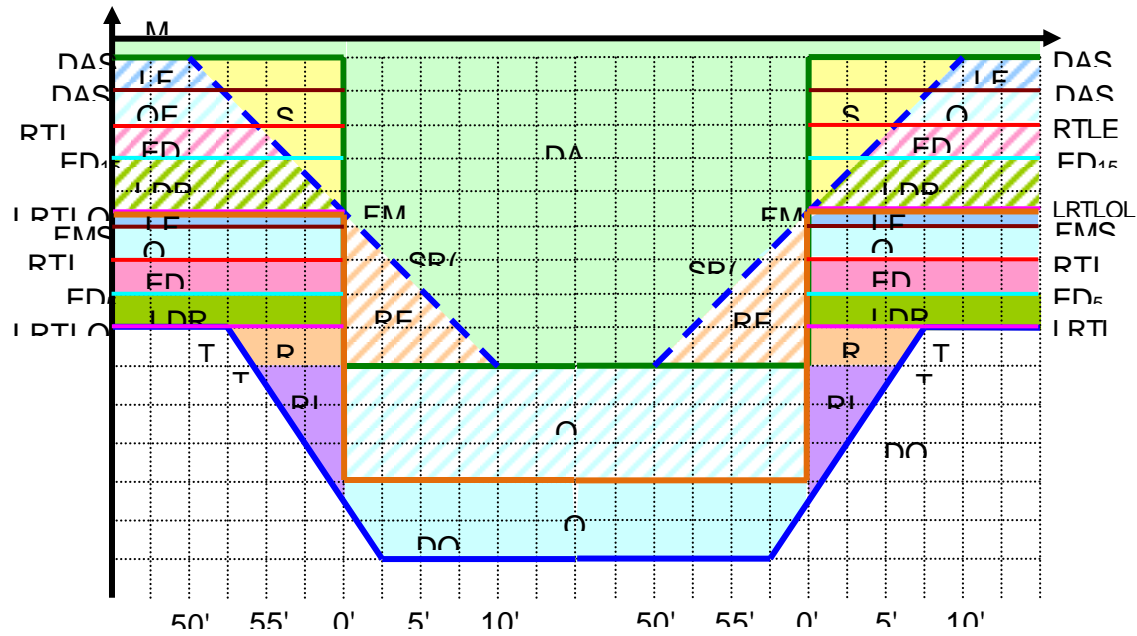

Figure 5i Instructed Imbalance Energy Stack for a NGR. Load side, RTD dispatch less than DA schedule.

$$i \in S_{NGR}$$



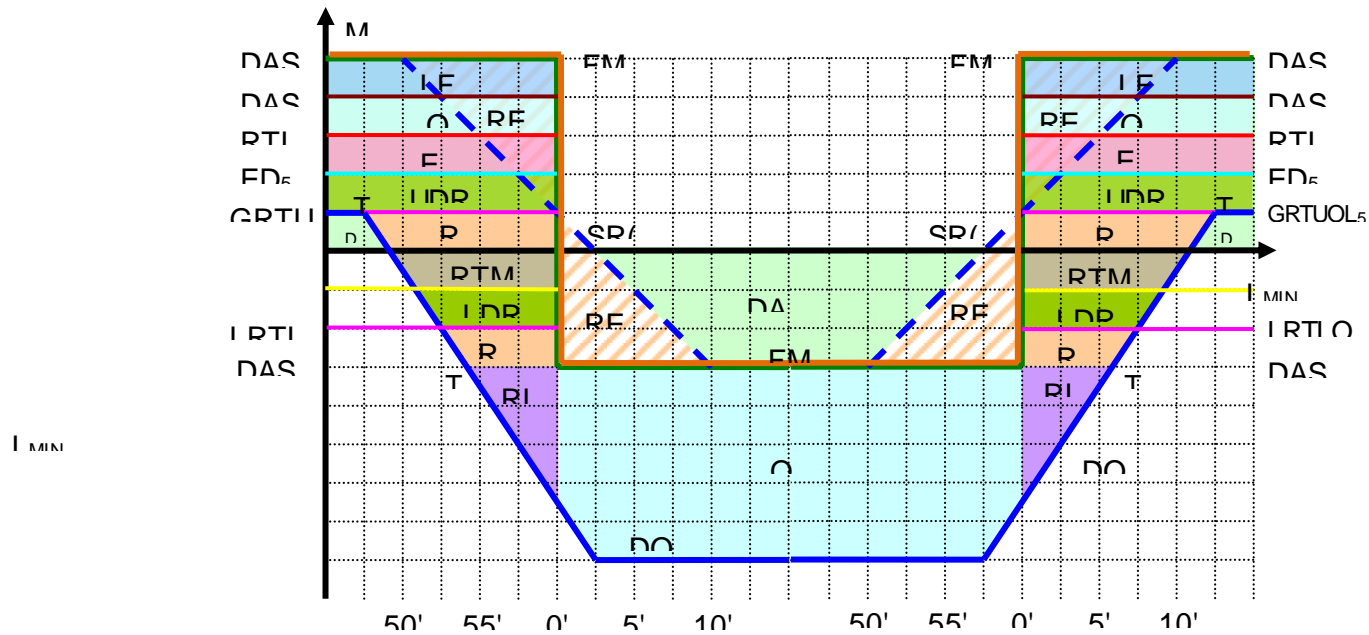

Figure 5k Instructed Imbalance Energy Stack for a NGR. RTD dispatch mainly on load side with some on generation side, DA schedule on generation side.

$$i \in S_{NGR}$$



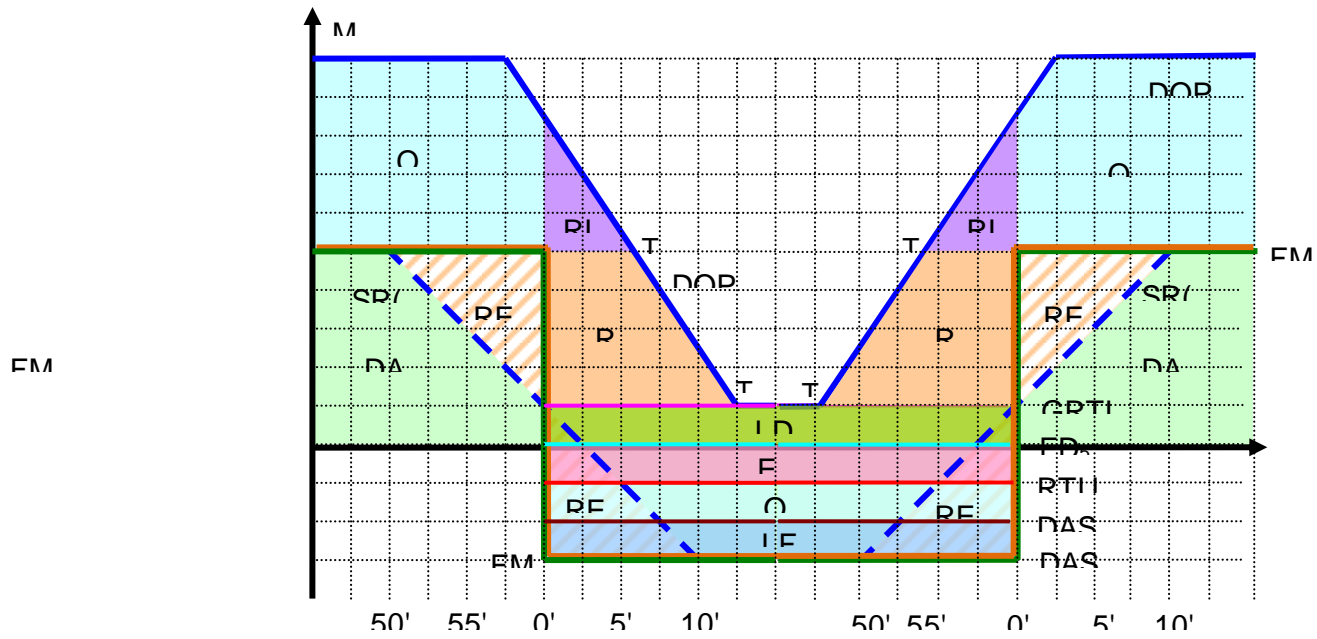

Figure 5I Instructed Imbalance Energy Stack for a NGR. Similar to item j above, but RTD dispatch stays on generation side.

$$i \in S_{NGR}$$

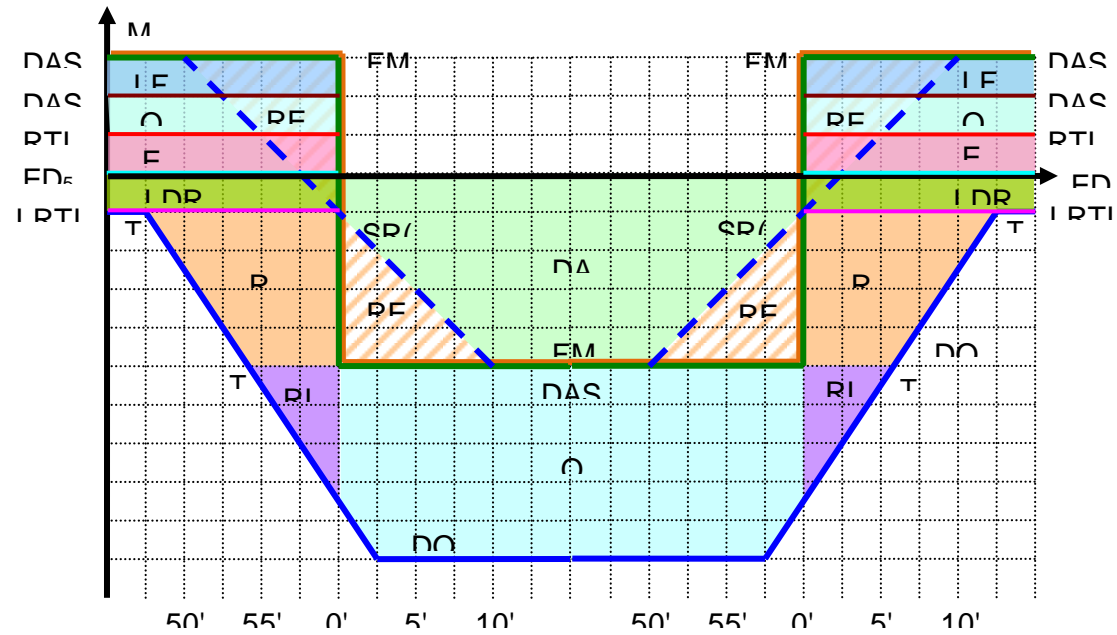

Figure 5m Instructed Imbalance Energy Stack for a NGR. Similar to item k above, but RTD dispatch stays on load side.

$$i \in S_{NGR}$$

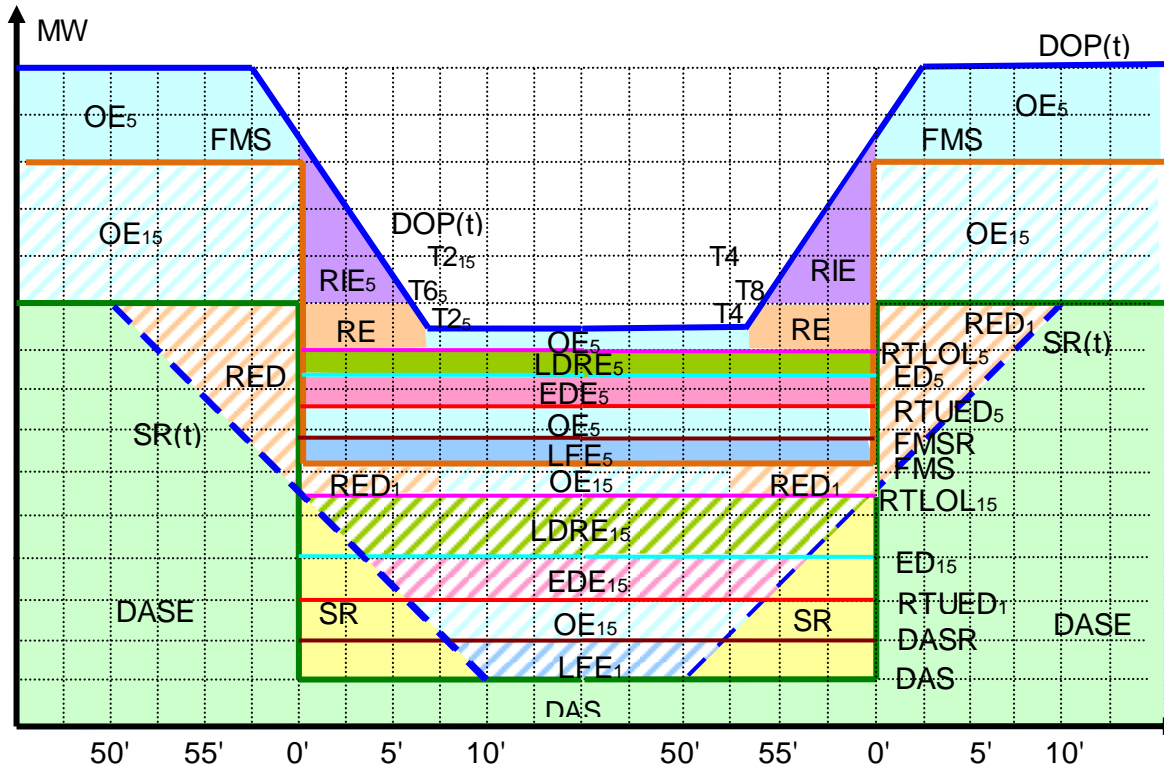

Figure 5n. Instructed Imbalance Energy Stack for Generating Resource. Special OE Case. RTD dispatch greater than DA schedule.

$$i \in S_{GEN} \cup S_{NGR}$$

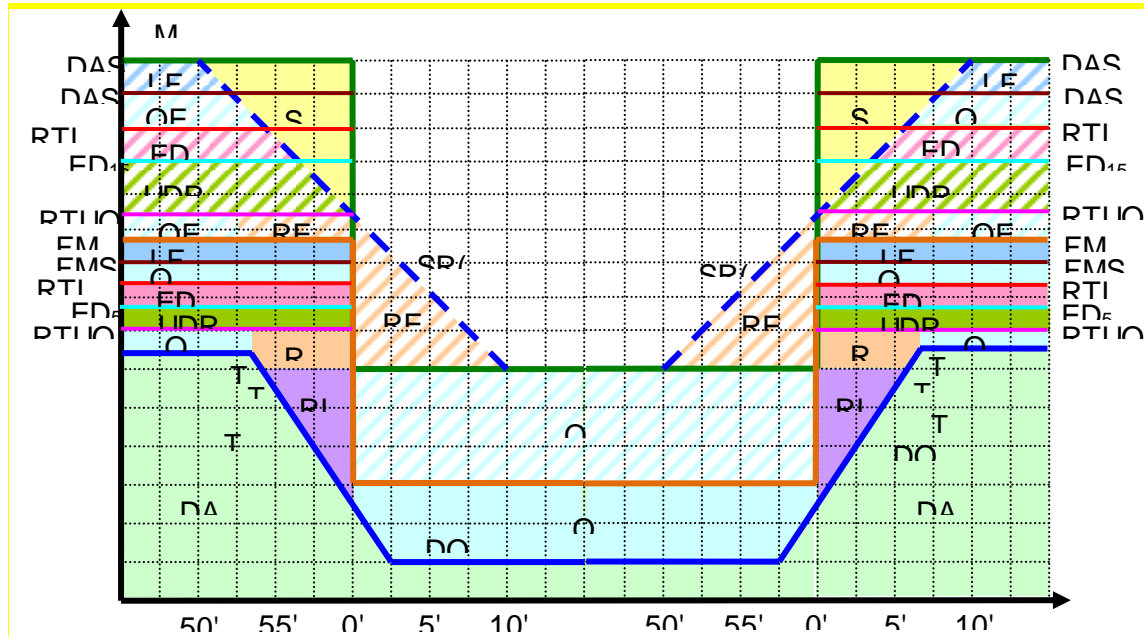

Figure 5o Instructed Imbalance Energy Stack for Generating Resource. Special OE Case. RTD dispatch less than DA schedule.

$$i \in S_{GEN} \cup S_{NGR}$$

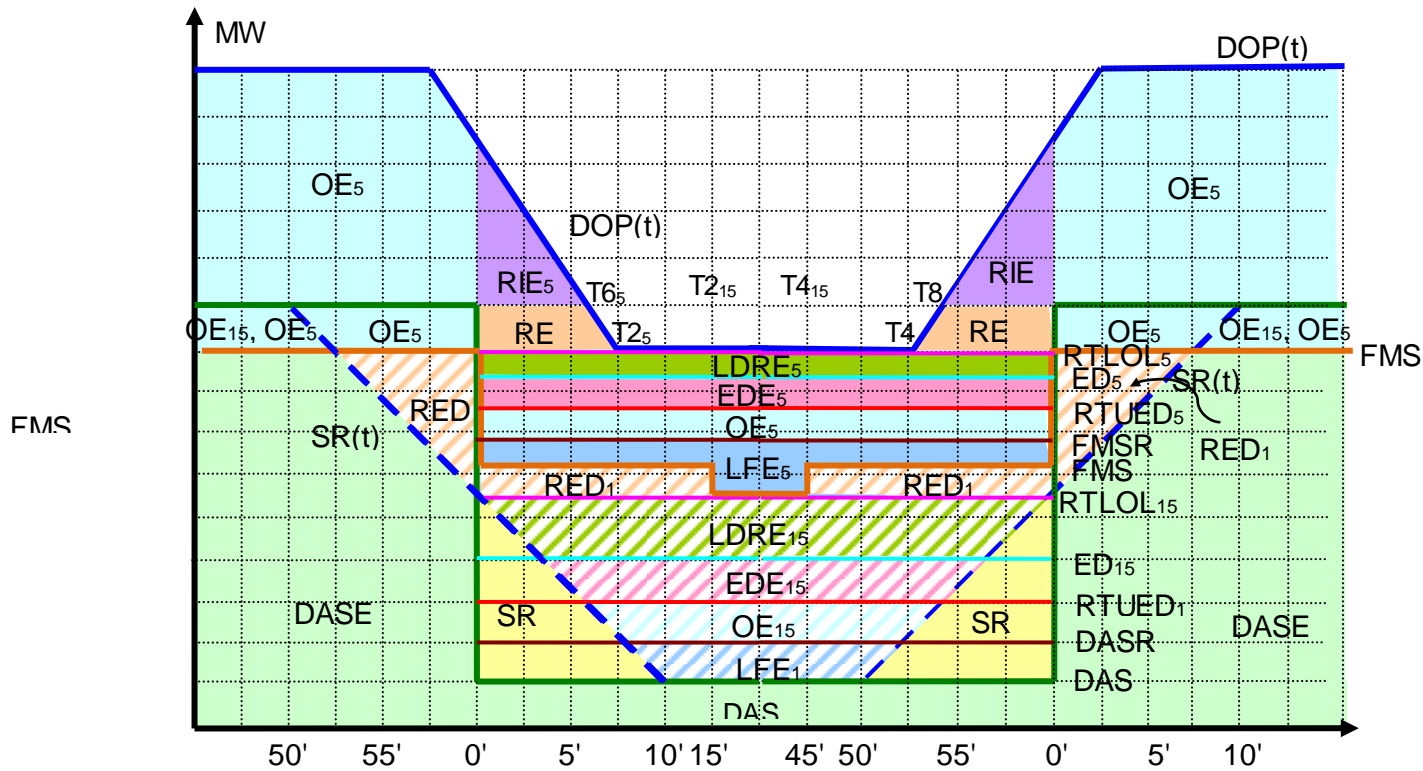

Figure 5p Instructed Imbalance Energy Stack for Generating Resource. Special RED Case. RTD dispatch greater than DA schedule.

$$i \in S_{GEN} \cup S_{NGR}$$

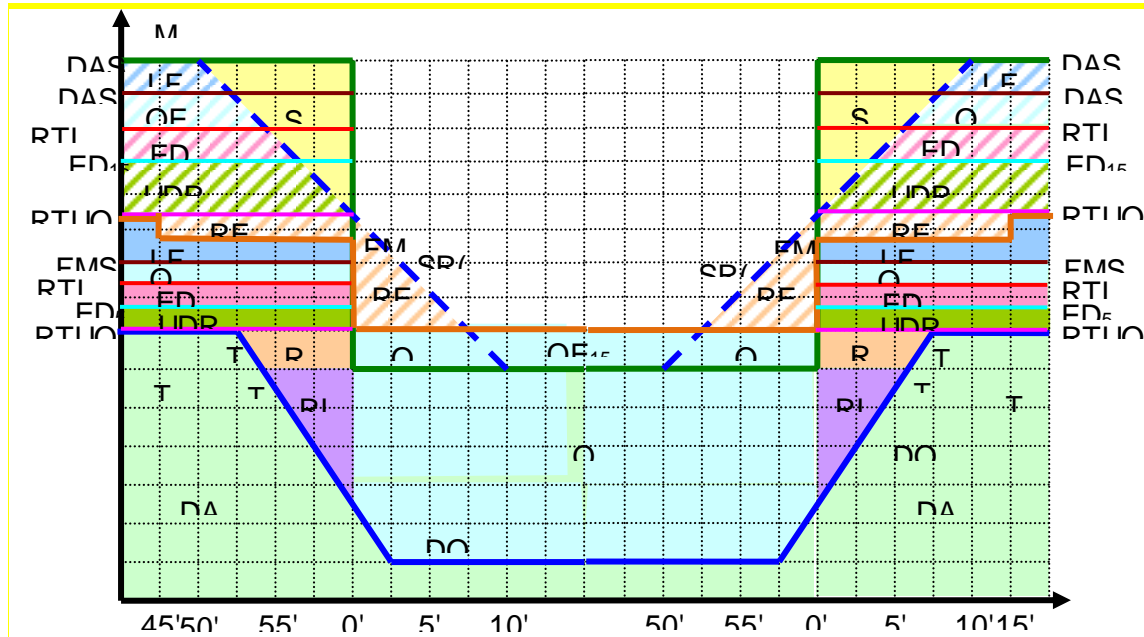

Figure 5q Instructed Imbalance Energy Stack for Generating Resource. Special RED Case. RTD dispatch less than DA schedule.

$$i \in S_{GEN} \cup S_{NGR}$$

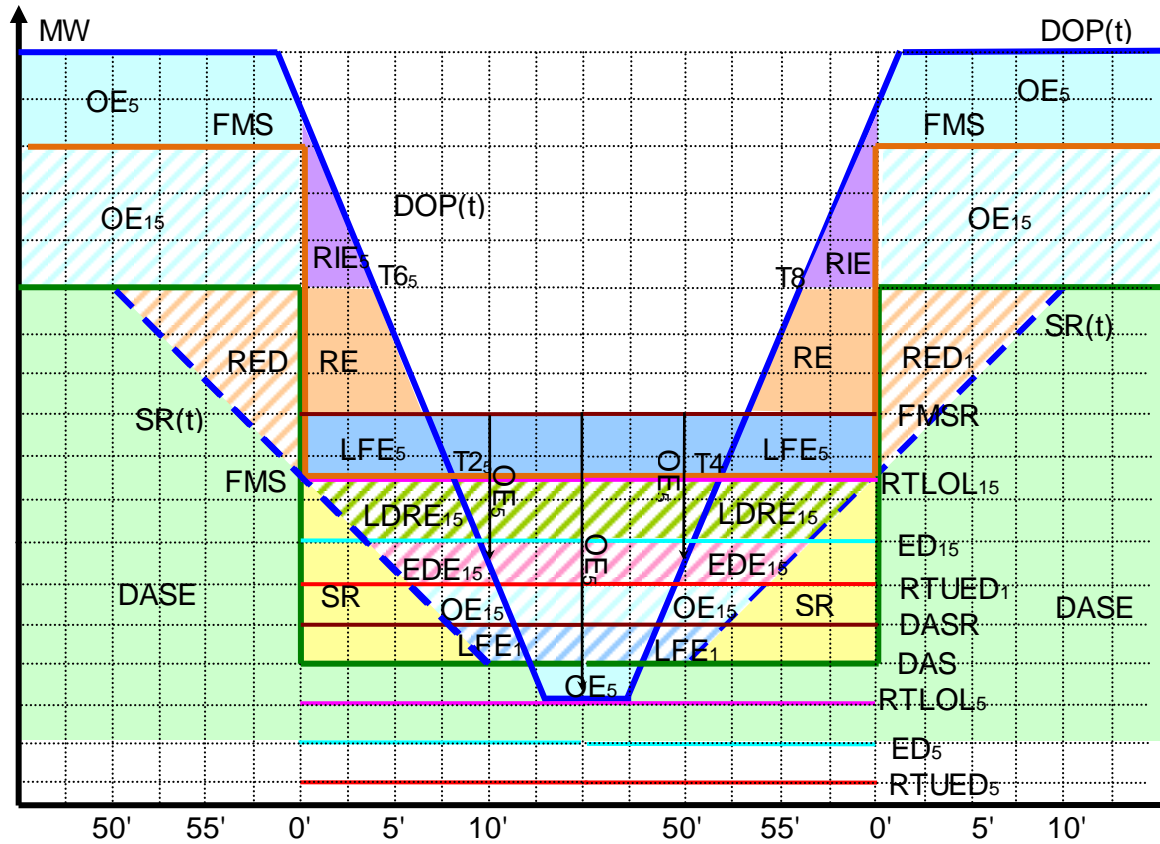

Figure 5r Instructed Imbalance Energy Stack for Generating Resource. Special DRE & EDE Case. At various intervals RTD dispatch is either greater than or less than DA schedule.  $i \in S_{GEN} \cup S_{NGR}$

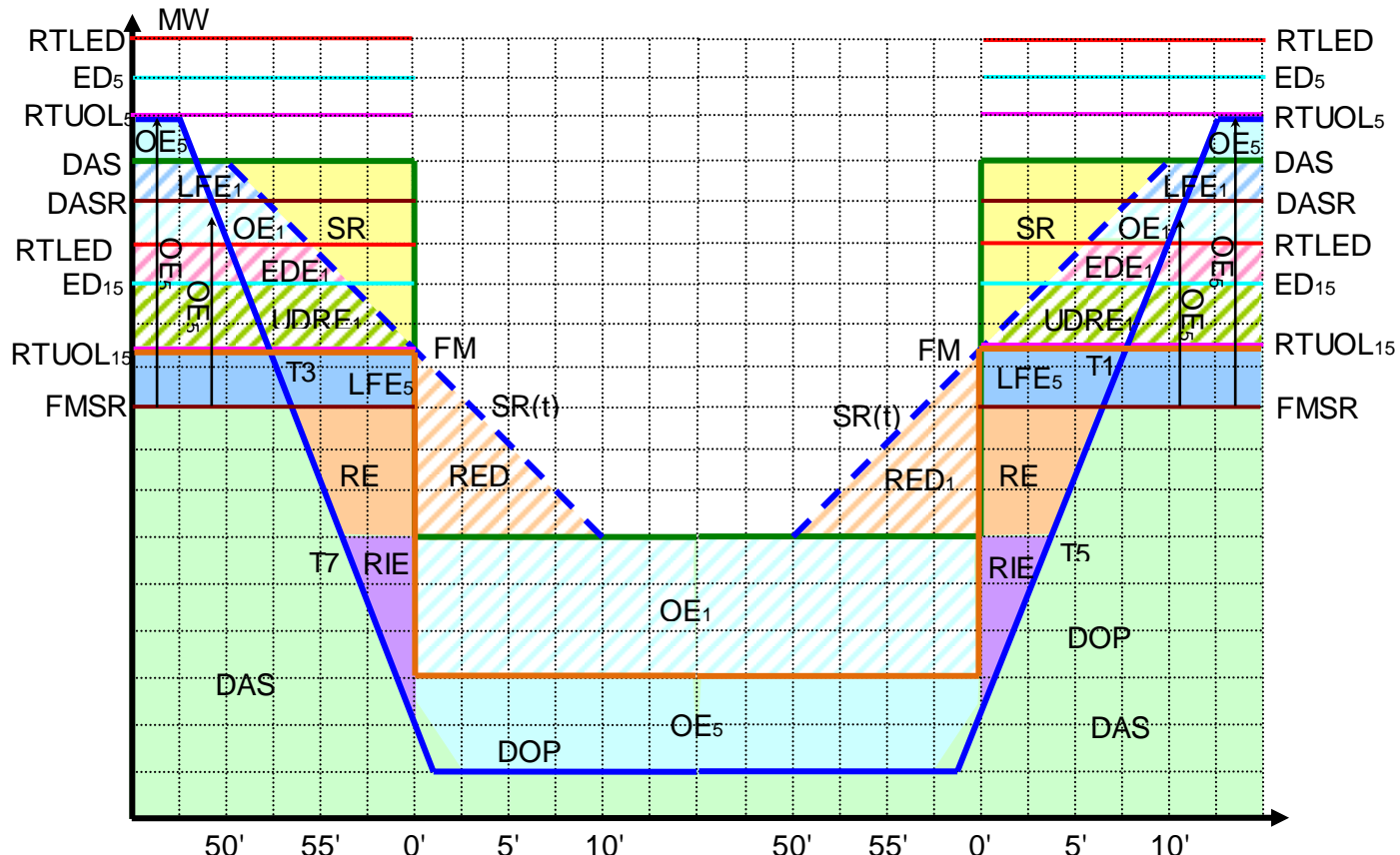

Figure 5s Instructed Imbalance Energy Stack for Generating Resource. Special DRE & EDE Case. At various intervals  $i \in S_{GEN} \cup S_{NGR}$  RTD dispatch is either less than or greater than DA schedule.



### C.2.1.18 Ramping Energy Deviation

The Ramping Energy Deviation is the sum of the Overlapping Ramping Energy Deviation that overlaps (and cancels) with Standard Ramping Energy and the Non-overlapping Ramping Energy Deviation:

$$\left\{ \begin{array}{l} RED_{i,m,h,f} = ORED_{i,m,h,f} + NRED_{i,m,h,f} \quad \therefore m \in FMM \\ RED_{i,m,h,k} = ORED_{i,m,h,k} + NRED_{i,m,h,k} \quad \therefore m \in RTD \end{array} \right\} \therefore i \in S_{GEN}$$

$$RED_{i,h,k} = RED_{i,FMM,h,f} + RED_{i,RTD,h,k} \quad \therefore i \in S_{GEN}$$

$$\left\{ \begin{array}{l} RED_{i,m,h,f} = ORED_{i,m,h,f} + GNRED_{i,m,h,f} + LNRED_{i,m,h,f} \quad \therefore m \in FMM \\ RED_{i,m,h,k} = ORED_{i,m,h,k} + GNRED_{i,m,h,k} + LNRED_{i,m,h,k} \quad \therefore m \in RTD \end{array} \right\} \therefore i \in S_{NGR}$$

$$RED_{i,h,k} = RED_{i,FMM,h,f} + RED_{i,RTD,h,k} \quad \therefore i \in S_{NGR}$$

The total RED shall be settled as 5 minute RTD values.

The Overlapping Ramping Energy Deviation is calculated as follows:

$$\left\{ \begin{array}{l}
 \left. \begin{array}{l}
 ORED_{i,m,h,f} = \begin{cases} \int_{T_{h,f-1}}^{T_{h,f}} \frac{\min(0, \max(FMS_{i,h,f}, DAS_{i,h}) - SR_{i,h}(t))}{3600} dt & \because SR_{i,h}(t) > DAS_{i,h} \\
 \int_{T_{h,f-1}}^{T_{h,f}} \frac{\max(0, \min(FMS_{i,h,f}, DAS_{i,h}) - SR_{i,h}(t))}{3600} dt & \because SR_{i,h}(t) < DAS_{i,h} \end{cases} \\
 f = 1,2,3,4 \quad \because m \in FMM
 \end{array} \right\} \\
 ORED_{i,m,h,k} = 0 \quad \quad \quad k = 1,2,11,12 \quad \because m \in RTD
 \end{array} \right. \Rightarrow \because i \notin S_{HPD} \cup S_{TIE} \cup S_{ECA}$$

The Non-overlapping Ramping Energy Deviation may occur at the start and/or end of the Trading Hour, and only for as long as the Dispatch Operating Point Slope Direction remains increasing or decreasing, as the relevant case may be. The Non-overlapping Ramping Energy Deviation can be determined by searching forward from the start of the Trading Hour and backward from the end of the Trading Hour as follows:

$$\begin{aligned}
 NRED_{i,m,h} = & \left\{ \begin{aligned} & \int_{T_{h,0}^1}^{T_{h,0}^2} \frac{\min(0, \max(FMS_{i,h}(t), DAS_{i,h-1})) - \min(RTUOL_{i,m,h}(t), ED_{BNDi,m,h}(t), RTLED_{i,m,h}(t), DASR_{i,h}(t), SR_{i,h}(t)))}{3600} dt \quad \because DAS_{i,h-1} < DAS_{i,h} \\ & \int_{T_{h,0}^2}^{T_{h,0}^3} \frac{\max(0, \min(FMS_{i,h}(t), DAS_{i,h-1})) - \max(RTLOL_{i,m,h}(t), ED_{BNDi,m,h}(t), RTUED_{i,m,h}(t), DASR_{i,h}(t), SR_{i,h}(t)))}{3600} dt \quad \because DAS_{i,h-1} > DAS_{i,h} \end{aligned} \right\} + \\
 & \left\{ \begin{aligned} & \int_{T_{h,0}^3}^{T_{h,0}^4} \frac{\min(0, \max(FMS_{i,h}(t), DAS_{i,h+1})) - \min(RTUOL_{i,m,h}(t), ED_{BNDi,m,h}(t), RTLED_{i,m,h}(t), DASR_{i,h}(t), SR_{i,h}(t)))}{3600} dt \quad \because DAS_{i,h+1} < DAS_{i,h} \\ & \int_{T_{h,0}^4}^{T_{h,0}^5} \frac{\max(0, \min(FMS_{i,h}(t), DAS_{i,h+1})) - \max(RTLOL_{i,m,h}(t), ED_{BNDi,m,h}(t), RTUED_{i,m,h}(t), DASR_{i,h}(t), SR_{i,h}(t)))}{3600} dt \quad \because DAS_{i,h+1} > DAS_{i,h} \end{aligned} \right\} \\
 & \therefore m \in FMM, \therefore i \in S_{NGR} \cup S_{HPD} \cup S_{TIE} \cup S_{ECA} \cup S_{HDR}
 \end{aligned}$$

$$\begin{aligned}
 NRED_{i,m,h} = & \left\{ \begin{aligned} & \int_{T_{h,0}^1}^{T_{h,0}^2} \frac{\min(0, \max(DOP_i(t), DAS_{i,h-1})) - \min(RTUOL_{i,m,h}(t), ED_{BNDi,m,h}(t), RTLED_{i,m,h}(t), FMSR_{i,h}(t), FMS_{i,h}(t)))}{3600} dt \quad \because DAS_{i,h-1} < DAS_{i,h} \\ & \int_{T_{h,0}^2}^{T_{h,0}^3} \frac{\max(0, \min(DOP_i(t), DAS_{i,h-1})) - \max(RTLOL_{i,m,h}(t), ED_{BNDi,m,h}(t), RTUED_{i,m,h}(t), FMSR_{i,h}(t), FMS_{i,h}(t)))}{3600} dt \quad \because DAS_{i,h-1} > DAS_{i,h} \end{aligned} \right\} + \\
 & \left\{ \begin{aligned} & \int_{T_{h,0}^3}^{T_{h,0}^4} \frac{\min(0, \max(DOP_i(t), DAS_{i,h+1})) - \min(RTUOL_{i,m,h}(t), ED_{BNDi,m,h}(t), RTLED_{i,m,h}(t), FMSR_{i,h}(t), FMS_{i,h}(t)))}{3600} dt \quad \because DAS_{i,h+1} < DAS_{i,h} \\ & \int_{T_{h,0}^4}^{T_{h,0}^5} \frac{\max(0, \min(DOP_i(t), DAS_{i,h+1})) - \max(RTLOL_{i,m,h}(t), ED_{BNDi,m,h}(t), RTUED_{i,m,h}(t), FMSR_{i,h}(t), FMS_{i,h}(t)))}{3600} dt \quad \because DAS_{i,h+1} > DAS_{i,h} \end{aligned} \right\} \\
 & \therefore m \in RTD, \therefore i \in S_{NGR} \cup S_{HPD} \cup S_{TIE} \cup S_{ECA} \cup S_{HDR}
 \end{aligned}$$

$$GNRED_{i,m,h} = \left\{ \begin{array}{l} \int_{T_{h,0}}^{T_m^1} \frac{\min(0, \max(0, FMS_{i,h}(t), DAS_{i,h-1})) - \min(GRTUOL_{i,m,h}(t), ED_{BNDi,m,h}(t), RTLED_{i,m,h}(t), DASR_{i,h}(t), SR_{i,h}(t)))}{3600} dt \quad \because DAS_{i,h-1} < DAS_{i,h} \\ \int_{T_{h,0}}^{T_m^2} \frac{\max(0, \min(FMS_{i,h}(t), DAS_{i,h-1})) - \max(GRTLLOL_{i,m,h}(t), ED_{BNDi,m,h}(t), RTUED_{i,m,h}(t), DASR_{i,h}(t), SR_{i,h}(t)))}{3600} dt \quad \because DAS_{i,h-1} > DAS_{i,h} \end{array} \right\} + \\
\left\{ \begin{array}{l} \int_{T_{h+1,0}}^{T_m^3} \frac{\min(0, \max(0, FMS_{i,h}(t), DAS_{i,h+1})) - \min(GRTUOL_{i,m,h}(t), ED_{BNDi,m,h}(t), RTLED_{i,m,h}(t), DASR_{i,h}(t), SR_{i,h}(t)))}{3600} dt \quad \because DAS_{i,h+1} < DAS_{i,h} \\ \int_{T_{h+1,0}}^{T_m^4} \frac{\max(0, \min(FMS_{i,h}(t), DAS_{i,h+1})) - \max(GRTLLOL_{i,m,h}(t), ED_{BNDi,m,h}(t), RTUED_{i,m,h}(t), DASR_{i,h}(t), SR_{i,h}(t)))}{3600} dt \quad \because DAS_{i,h+1} > DAS_{i,h} \end{array} \right\} \\
\therefore m \in FMM, \therefore i \in S_{NGR}$$

$$GNRED_{i,m,h} = \left\{ \begin{array}{l} \int_{T_{h,0}}^{T_m^1} \frac{\min(0, \max(0, DOP_i(t), DAS_{i,h-1})) - \min(GRTUOL_{i,m,h}(t), ED_{BNDi,m,h}(t), RTLED_{i,m,h}(t), FMSR_{i,h}(t), FMS_{i,h}(t)))}{3600} dt \quad \because DAS_{i,h-1} < DAS_{i,h} \\ \int_{T_{h,0}}^{T_m^2} \frac{\max(0, \min(DOP_i(t), DAS_{i,h-1})) - \max(GRTLLOL_{i,m,h}(t), ED_{BNDi,m,h}(t), RTUED_{i,m,h}(t), FMSR_{i,h}(t), FMS_{i,h}(t)))}{3600} dt \quad \because DAS_{i,h-1} > DAS_{i,h} \end{array} \right\} + \\
\left\{ \begin{array}{l} \int_{T_{h+1,0}}^{T_m^3} \frac{\min(0, \max(0, DOP_i(t), DAS_{i,h+1})) - \min(GRTUOL_{i,m,h}(t), ED_{BNDi,m,h}(t), RTLED_{i,m,h}(t), FMSR_{i,h}(t), FMS_{i,h}(t)))}{3600} dt \quad \because DAS_{i,h+1} < DAS_{i,h} \\ \int_{T_{h+1,0}}^{T_m^4} \frac{\max(0, \min(DOP_i(t), DAS_{i,h+1})) - \max(GRTLLOL_{i,m,h}(t), ED_{BNDi,m,h}(t), RTUED_{i,m,h}(t), FMSR_{i,h}(t), FMS_{i,h}(t)))}{3600} dt \quad \because DAS_{i,h+1} > DAS_{i,h} \end{array} \right\} \\
\therefore m \in RTD, \therefore i \in S_{NGR}$$

$$\begin{aligned}
 LNRED_{i,m,h} = & \left\{ \int_{T_{h,0}}^{T_1^m} \frac{\min(0, \max(FMS_{i,h}(t), DAS_{i,h-1}) - \min(LRTL_{i,m,h}(t), ED_{BNDi,m,h}(t), RTLED_{i,m,h}(t), DASR_{i,h}(t), SR_{i,h}(t)))}{3600} dt \quad \because DAS_{i,h-1} < DAS_{i,h} \right. \\
 & \left. + \int_{T_{h,0}}^{T_2^m} \frac{\max(0, \min(0, FMS_{i,h}(t), DAS_{i,h-1}) - \max(LRTUOL_{i,m,h}(t), ED_{BNDi,m,h}(t), RTUED_{i,m,h}(t), DASR_{i,h}(t), SR_{i,h}(t)))}{3600} dt \quad \because DAS_{i,h-1} > DAS_{i,h} \right\} \\
 & \left\{ \int_{T_{h+1,0}}^{T_3^m} \frac{\min(0, \max(FMS_{i,h}(t), DAS_{i,h+1}) - \min(LRTL_{i,m,h}(t), ED_{BNDi,m,h}(t), RTLED_{i,m,h}(t), DASR_{i,h}(t), SR_{i,h}(t)))}{3600} dt \quad \because DAS_{i,h+1} < DAS_{i,h} \right. \\
 & \left. + \int_{T_{h+1,0}}^{T_4^m} \frac{\max(0, \min(0, FMS_{i,h}(t), DAS_{i,h+1}) - \max(LRTUOL_{i,m,h}(t), ED_{BNDi,m,h}(t), RTUED_{i,m,h}(t), DASR_{i,h}(t), SR_{i,h}(t)))}{3600} dt \quad \because DAS_{i,h+1} > DAS_{i,h} \right\} \\
 & \therefore m \in FMM, \therefore i \in S_{NGR}
 \end{aligned}$$

$$\begin{aligned}
 LNRED_{i,m,h} = & \left\{ \int_{T_{h,0}}^{T_1^m} \frac{\min(0, \max(DOP_i(t), DAS_{i,h-1}) - \min(LRTL_{i,m,h}(t), ED_{BNDi,m,h}(t), RTLED_{i,m,h}(t), FMSR_{i,h}(t), FMS_{i,h}(t)))}{3600} dt \quad \because DAS_{i,h-1} < DAS_{i,h} \right. \\
 & \left. + \int_{T_{h,0}}^{T_2^m} \frac{\max(0, \min(0, DOP_i(t), DAS_{i,h-1}) - \max(LRTUOL_{i,m,h}(t), ED_{BNDi,m,h}(t), RTUED_{i,m,h}(t), FMSR_{i,h}(t), FMS_{i,h}(t)))}{3600} dt \quad \because DAS_{i,h-1} > DAS_{i,h} \right\} \\
 & \left\{ \int_{T_{h+1,0}}^{T_3^m} \frac{\min(0, \max(DOP_i(t), DAS_{i,h+1}) - \min(LRTL_{i,m,h}(t), ED_{BNDi,m,h}(t), RTLED_{i,m,h}(t), FMSR_{i,h}(t), FMS_{i,h}(t)))}{3600} dt \quad \because DAS_{i,h+1} < DAS_{i,h} \right. \\
 & \left. + \int_{T_{h+1,0}}^{T_4^m} \frac{\max(0, \min(0, DOP_i(t), DAS_{i,h+1}) - \max(LRTUOL_{i,m,h}(t), ED_{BNDi,m,h}(t), RTUED_{i,m,h}(t), FMSR_{i,h}(t), FMS_{i,h}(t)))}{3600} dt \quad \because DAS_{i,h+1} > DAS_{i,h} \right\} \\
 & \therefore m \in RTD, \therefore i \in S_{NGR}
 \end{aligned}$$

Where the integration terminating times are determined as follows for all resources:

$$\left. \begin{array}{l}
T1_m = \max T \quad \therefore \left\{ \begin{array}{l} s_{i,m}(t) = 1 \\ FMS_{i,h}(t) < \min(ED_{BNDi,m,h}(t), RTLED_{i,m,h}(t), SR_{i,h}(t)) - TOL \end{array} \right\} \quad \therefore T_{h,0} \leq t \leq T \leq T_{h+1,0} \\
T2_m = \max T \quad \therefore \left\{ \begin{array}{l} s_{i,m}(t) = -1 \\ FMS_{i,h}(t) > \max(ED_{BNDi,m,h}(t), RTUED_{i,m,h}(t), SR_{i,h}(t)) + TOL \end{array} \right\} \quad \therefore T_{h,0} \leq t \leq T \leq T_{h+1,0} \\
T3_m = \min T \quad \therefore \left\{ \begin{array}{l} s_{i,m}(t) = -1 \\ FMS_{i,h}(t) < \min(ED_{BNDi,m,h}(t), RTLED_{i,m,h}(t), SR_{i,h}(t)) - TOL \end{array} \right\} \quad \therefore T_{h+1,0} \geq t \geq T \geq T_{h,0} \\
T4_m = \min T \quad \therefore \left\{ \begin{array}{l} s_{i,m}(t) = 1 \\ FMS_{i,h}(t) > \max(ED_{BNDi,m,h}(t), RTUED_{i,m,h}(t), SR_{i,h}(t)) + TOL \end{array} \right\} \quad \therefore T_{h+1,0} \geq t \geq T \geq T_{h,0}
\end{array} \right\} \quad \therefore m \in FMM$$

$$\left. \begin{array}{l}
T1_m = \max T \quad \therefore \left\{ \begin{array}{l} s_{i,m}(t) = 1 \\ DOP_i(t) < \min(ED_{BNDi,m,h}(t), RTLED_{i,m,h}(t), FMS_{i,h}(t)) - TOL \end{array} \right\} \quad \therefore T_{h,0} \leq t \leq T \leq T_{h+1,0} \\
T2_m = \max T \quad \therefore \left\{ \begin{array}{l} s_{i,m}(t) = -1 \\ DOP_i(t) > \max(ED_{BNDi,m,h}(t), RTUED_{i,m,h}(t), FMS_{i,h}(t)) + TOL \end{array} \right\} \quad \therefore T_{h,0} \leq t \leq T \leq T_{h+1,0} \\
T3_m = \min T \quad \therefore \left\{ \begin{array}{l} s_{i,m}(t) = -1 \\ DOP_i(t) < \min(ED_{BNDi,m,h}(t), RTLED_{i,m,h}(t), FMS_{i,h}(t)) - TOL \end{array} \right\} \quad \therefore T_{h+1,0} \geq t \geq T \geq T_{h,0} \\
T4_m = \min T \quad \therefore \left\{ \begin{array}{l} s_{i,m}(t) = 1 \\ DOP_i(t) > \max(ED_{BNDi,m,h}(t), RTUED_{i,m,h}(t), FMS_{i,h}(t)) + TOL \end{array} \right\} \quad \therefore T_{h+1,0} \geq t \geq T \geq T_{h,0}
\end{array} \right\} \quad \therefore m \in RTD$$

### C.2.1.19 Residual Imbalance Energy

The Residual Imbalance Energy may occur at the start and/or end of the Trading Hour, and only for as long as the Slope Direction of either the Ramping FMS for FMM, or Dispatch Operating Point for RTD market, as applicable, remains increasing or decreasing, as the relevant case may be. The Residual Imbalance Energy at the top and bottom of the Trading Hour can be determined by searching forward from the start of the Trading Hour and backward from the end of the Trading Hour as follows:

$$\left\{ \begin{array}{l} RIE_{i,m,h,f} = TRIE_{i,m,h,f} + BRIE_{i,m,h,f} \quad \therefore m \in FMM \\ RIE_{i,m,h,k} = TRIE_{i,m,h,k} + BRIE_{i,m,h,k} \quad \therefore m \in RTD \end{array} \right\} \therefore i \notin S_{NGR} \cup S_{HPD} \cup S_{TIE} \cup S_{ECA} \quad \color{yellow}\blacksquare$$

$$RIE_{i,h,k} = RIE_{i,FMM,h,f} + RIE_{i,RTD,h,k} \quad \therefore i \notin S_{NGR} \cup S_{HPD} \cup S_{TIE} \cup S_{ECA} \quad \color{yellow}\blacksquare$$

The total RIE shall be settled as 5 minute RTD values.

$$TRIE_{i,m,h} = \left\{ \begin{array}{l} \int_{T_{h,0}}^{T_{h,0}^{5m}} \frac{\min(0, FMS_{i,h}(t) - \min(DAS_{i,h-1}, DAS_{i,h}, RTUOL_{i,m,h}(t), ED_{BNDi,m,h}(t), RTLED_{i,m,h}(t), DASR_{i,h}(t), SR_{i,h}(t)))}{3600} dt \quad \therefore FMS_{i,h}(T_{h,0}) < DAS_{i,h} \\ \int_{T_{h,0}}^{T_{h,0}^{6m}} \frac{\max(0, FMS_{i,h}(t) - \max(DAS_{i,h-1}, DAS_{i,h}, RTLOL_{i,m,h}(t), ED_{BNDi,m,h}(t), RTUED_{i,m,h}(t), DASR_{i,h}(t), SR_{i,h}(t)))}{3600} dt \quad \therefore FMS_{i,h}(T_{h,0}) > DAS_{i,h} \end{array} \right\} \\ \therefore m \in FMM, \therefore i \notin S_{NGR} \cup S_{HPD} \cup S_{TIE} \cup S_{ECA} \quad \color{yellow}\blacksquare$$

$$TRIE_{i,m,h} = \left\{ \begin{array}{l} \int_{T_{h,0}}^{T_{h,0}^{5m}} \frac{\min(0, DOP_i(t) - \min(DAS_{i,h-1}, DAS_{i,h}, RTUOL_{i,m,h}(t), ED_{BNDi,m,h}(t), RTLED_{i,m,h}(t), FMSR_{i,h}(t), FMS_{i,h}(t)))}{3600} dt \quad \therefore DOP_i(T_{h,0}) < DAS_{i,h} \\ \int_{T_{h,0}}^{T_{h,0}^{6m}} \frac{\max(0, DOP_i(t) - \max(DAS_{i,h-1}, DAS_{i,h}, RTLOL_{i,m,h}(t), ED_{BNDi,m,h}(t), RTUED_{i,m,h}(t), FMSR_{i,h}(t), FMS_{i,h}(t)))}{3600} dt \quad \therefore DOP_i(T_{h,0}) > DAS_{i,h} \end{array} \right\} \\ \therefore m \in RTD, \therefore i \notin S_{NGR} \cup S_{HPD} \cup S_{TIE} \cup S_{ECA} \quad \color{yellow}\blacksquare$$

$$BRIE_{i,m,h} = \begin{cases} \int_{T_{h+1,0}}^{T_{7m}} \frac{\min(0, FMS_{i,h}(t) - \min(DAS_{i,h+1}, DAS_{i,h}, RTUOL_{i,m,h}(t), ED_{BNDi,m,h}(t), RTLED_{i,m,h}(t), DASR_{i,h}(t), SR_{i,h}(t)))}{3600} dt & \because FMS_{i,h}(T_{h+1,0}) < DAS_{i,h} \\ \int_{T_{8m}}^{T_{h+1,0}} \frac{\max(0, FMS_{i,h}(t) - \max(DAS_{i,h+1}, DAS_{i,h}, RTLOL_{i,m,h}(t), ED_{BNDi,m,h}(t), RTUED_{i,m,h}(t), DASR_{i,h}(t), SR_{i,h}(t)))}{3600} dt & \because FMS_{i,h}(T_{h+1,0}) > DAS_{i,h} \end{cases}$$

$\therefore m \in FMM, \therefore i \notin S_{NGR} \cup S_{HPD} \cup S_{TIE} \cup S_{ECA}$  

$$BRIE_{i,m,h} = \begin{cases} \int_{T_{h+1,0}}^{T_{7m}} \frac{\min(0, DOP_i(t) - \min(DAS_{i,h+1}, DAS_{i,h}, RTUOL_{i,m,h}(t), ED_{BNDi,m,h}(t), RTLED_{i,m,h}(t), FMSR_{i,h}(t), FMS_{i,h}(t)))}{3600} dt & \because DOP_i(T_{h+1,0}) < DAS_{i,h} \\ \int_{T_{8m}}^{T_{h+1,0}} \frac{\max(0, DOP_i(t) - \max(DAS_{i,h+1}, DAS_{i,h}, RTLOL_{i,m,h}(t), ED_{BNDi,m,h}(t), RTUED_{i,m,h}(t), FMSR_{i,h}(t), FMS_{i,h}(t)))}{3600} dt & \because DOP_i(T_{h+1,0}) > DAS_{i,h} \end{cases}$$

$\therefore m \in RTD, \therefore i \notin S_{NGR} \cup S_{HPD} \cup S_{TIE} \cup S_{ECA}$  

$$\left\{ \begin{array}{l} RIE_{i,m,h,f} = GTRIE_{i,m,h,f} + LTRIE_{i,m,h,f} + GBRIE_{i,m,h,f} + LBRIE_{i,m,h,f} \quad \because m \in FMM \\ RIE_{i,m,h,k} = GTRIE_{i,m,h,k} + LTRIE_{i,m,h,k} + GBRIE_{i,m,h,k} + LBRIE_{i,m,h,k} \quad \because m \in RTD \end{array} \right\} \because i \in S_{NGR}$$

$$RIE_{i,h,k} = RIE_{i,FMM,h,f} + RIE_{i,RTD,h,k} \quad \because i \in S_{NGR}$$

The total RED shall be settled as 5 minute RTD values.



$$GTRIE_{i,m,h} = \left\{ \begin{array}{l} \int_{T_{h,0}}^{T_{h,0}^{5m}} \frac{\min(0, \max(0, FMS_{i,h}(t)) - \min(DAS_{i,h-1}, DAS_{i,h}, GRTUOL_{i,m,h}(t), ED_{BNDi,m,h}(t), RTLED_{i,m,h}(t), DASR_{i,h}(t)))}{3600} dt \quad \because FMS_{i,h}(T_{h,0}) < DAS_{i,h} \\ \int_{T_{h,0}}^{T_{h,0}^{6m}} \frac{\max(0, FMS_{i,h}(t) - \max(DAS_{i,h-1}, DAS_{i,h}, GRTLLOL_{i,m,h}(t), ED_{BNDi,m,h}(t), RTUED_{i,m,h}(t), DASR_{i,h}(t)))}{3600} dt \quad \because FMS_{i,h}(T_{h,0}) > DAS_{i,h} \end{array} \right\}$$

$\therefore m \in FMM, \therefore i \in S_{NGR}$

$$GTRIE_{i,m,h} = \left\{ \begin{array}{l} \int_{T_{h,0}}^{T_{h,0}^{5m}} \frac{\min(0, \max(0, DOP_i(t)) - \min(DAS_{i,h-1}, DAS_{i,h}, GRTUOL_{i,m,h}(t), ED_{BNDi,m,h}(t), RTLED_{i,m,h}(t), FMSR_{i,h}(t)))}{3600} dt \quad \because DOP_i(T_{h,0}) < DAS_{i,h} \\ \int_{T_{h,0}}^{T_{h,0}^{6m}} \frac{\max(0, DOP_i(t) - \max(DAS_{i,h-1}, DAS_{i,h}, GRTLLOL_{i,m,h}(t), ED_{BNDi,m,h}(t), RTUED_{i,m,h}(t), FMSR_{i,h}(t)))}{3600} dt \quad \because DOP_i(T_{h,0}) > DAS_{i,h} \end{array} \right\}$$

$\therefore m \in RTD, \therefore i \in S_{NGR}$

$$LTRIE_{i,m,h} = \left\{ \begin{array}{l} \int_{T_{h,0}}^{T_{h,0}^{5m}} \frac{\min(0, FMS_{i,h}(t) - \min(DAS_{i,h-1}, DAS_{i,h}, LRTLLOL_{i,m,h}(t), ED_{BNDi,m,h}(t), RTLED_{i,m,h}(t), DASR_{i,h}(t)))}{3600} dt \quad \because FMS_{i,h}(T_{h,0}) < DAS_{i,h} \\ \int_{T_{h,0}}^{T_{h,0}^{6m}} \frac{\max(0, \min(0, FMS_{i,h}(t)) - \max(DAS_{i,h-1}, DAS_{i,h}, LRTUOL_{i,m,h}(t), ED_{BNDi,m,h}(t), RTUED_{i,m,h}(t), DASR_{i,h}(t)))}{3600} dt \quad \because FMS_{i,h}(T_{h,0}) > DAS_{i,h} \end{array} \right\}$$

$\therefore m \in FMM, \therefore i \in S_{NGR}$

$$LTRIE_{i,m,h} = \left\{ \begin{array}{l} \int_{T_{h,0}}^{T_{h,0}^{5m}} \frac{\min(0, DOP_i(t) - \min(DAS_{i,h-1}, DAS_{i,h}, LRTLLOL_{i,m,h}(t), ED_{BNDi,m,h}(t), RTLED_{i,m,h}(t), FMSR_{i,h}(t)))}{3600} dt \quad \because DOP_i(T_{h,0}) < DAS_{i,h} \\ \int_{T_{h,0}}^{T_{h,0}^{6m}} \frac{\max(0, \min(0, DOP_i(t)) - \max(DAS_{i,h-1}, DAS_{i,h}, LRTUOL_{i,m,h}(t), ED_{BNDi,m,h}(t), RTUED_{i,m,h}(t), FMSR_{i,h}(t)))}{3600} dt \quad \because DOP_i(T_{h,0}) > DAS_{i,h} \end{array} \right\}$$

$\therefore m \in RTD, \therefore i \in S_{NGR}$

$$GBRIE_{i,m,h} = \left\{ \begin{array}{l} \int_{T_{h+1,0}}^{T_{7m}} \frac{\min(0, \max(0, FMS_{i,h}(t)) - \min(DAS_{i,h+1}, DAS_{i,h}, GRTUOL_{i,m,h}(t), ED_{BNDi,m,h}(t), RTLED_{i,m,h}(t), DASR_{i,h}(t)))}{3600} dt \quad \because FMS_{i,h}(T_{h+1,0}) < DAS_{i,h} \\ \int_{T_{8m}}^{T_{h+1,0}} \frac{\max(0, FMS_{i,h}(t) - \max(DAS_{i,h+1}, DAS_{i,h}, GRTLOL_{i,m,h}(t), ED_{BNDi,m,h}(t), RTUED_{i,m,h}(t), DASR_{i,h}(t)))}{3600} dt \quad \because FMS_{i,h}(T_{h+1,0}) > DAS_{i,h} \end{array} \right\}$$

$\therefore m \in FMM, \therefore i \in S_{NGR}$

$$GBRIE_{i,m,h} = \left\{ \begin{array}{l} \int_{T_{h+1,0}}^{T_{7m}} \frac{\min(0, \max(0, DOP_i(t)) - \min(DAS_{i,h+1}, DAS_{i,h}, GRTUOL_{i,m,h}(t), ED_{BNDi,m,h}(t), RTLED_{i,m,h}(t), FMSR_{i,h}(t)))}{3600} dt \quad \because DOP_i(T_{h+1,0}) < DAS_{i,h} \\ \int_{T_{8m}}^{T_{h+1,0}} \frac{\max(0, DOP_i(t) - \max(DAS_{i,h+1}, DAS_{i,h}, GRTLOL_{i,m,h}(t), ED_{BNDi,m,h}(t), RTUED_{i,m,h}(t), FMSR_{i,h}(t)))}{3600} dt \quad \because DOP_i(T_{h+1,0}) > DAS_{i,h} \end{array} \right\}$$

$\therefore m \in RTD, \therefore i \in S_{NGR}$

$$LBRIE_{i,m,h} = \left\{ \begin{array}{l} \int_{T_{h+1,0}}^{T_{7m}} \frac{\min(0, FMS_{i,h}(t) - \min(DAS_{i,h+1}, DAS_{i,h}, LRTLLOL_{i,m,h}(t), ED_{BNDi,m,h}(t), RTLED_{i,m,h}(t), DASR_{i,h}(t)))}{3600} dt \quad \because FMS_{i,h}(T_{h+1,0}) < DAS_{i,h} \\ \int_{T_{8m}}^{T_{h+1,0}} \frac{\max(0, \min(0, FMS_{i,h}(t)) - \max(DAS_{i,h+1}, DAS_{i,h}, LRTUOL_{i,m,h}(t), ED_{BNDi,m,h}(t), RTUED_{i,m,h}(t), DASR_{i,h}(t)))}{3600} dt \quad \because FMS_{i,h}(T_{h+1,0}) > DAS_{i,h} \end{array} \right\}$$

$\therefore m \in FMM, \therefore i \in S_{NGR}$

$$LBRIE_{i,m,h} = \left\{ \begin{array}{l} \int_{T_{h+1,0}}^{T_{7m}} \frac{\min(0, DOP_i(t) - \min(DAS_{i,h+1}, DAS_{i,h}, LRTLLOL_{i,m,h}(t), ED_{BNDi,m,h}(t), RTLED_{i,m,h}(t), FMSR_{i,h}(t)))}{3600} dt \quad \because DOP_i(T_{h+1,0}) < DAS_{i,h} \\ \int_{T_{8m}}^{T_{h+1,0}} \frac{\max(0, \min(0, DOP_i(t)) - \max(DAS_{i,h+1}, DAS_{i,h}, LRTUOL_{i,m,h}(t), ED_{BNDi,m,h}(t), RTUED_{i,m,h}(t), FMSR_{i,h}(t)))}{3600} dt \quad \because DOP_i(T_{h+1,0}) > DAS_{i,h} \end{array} \right\}$$

$\therefore m \in RTD, \therefore i \in S_{NGR}$

Where the integration terminating times are determined as follows for all resources:

$$\left. \begin{array}{l}
T5_m = \max T \quad \therefore \left\{ \begin{array}{l} s_{i,m}(t) = 1 \\ FMS_{i,h}(t) < \min(DAS_{i,h-1}, DAS_{i,h}, ED_{BNDi,m,h}(t), RTLED_{i,m,h}(t)) - TOL \end{array} \right\} \quad \therefore T_{h,0} \leq t \leq T \leq T_{h+1,0} \\
T6_m = \max T \quad \therefore \left\{ \begin{array}{l} s_{i,m}(t) = -1 \\ FMS_{i,h}(t) > \max(DAS_{i,h-1}, DAS_{i,h}, ED_{BNDi,m,h}(t), RTUED_{i,m,h}(t)) + TOL \end{array} \right\} \quad \therefore T_{h,0} \leq t \leq T \leq T_{h+1,0} \\
T7_m = \min T \quad \therefore \left\{ \begin{array}{l} s_{i,m}(t) = -1 \\ FMS_{i,h}(t) < \min(DAS_{i,h+1}, DAS_{i,h}, ED_{BNDi,m,h}(t), RTLED_{i,m,h}(t)) - TOL \end{array} \right\} \quad \therefore T_{h+1,0} \geq t \geq T \geq T_{h,0} \\
T8_m = \min T \quad \therefore \left\{ \begin{array}{l} s_{i,m}(t) = 1 \\ FMS_{i,h}(t) > \max(DAS_{i,h+1}, DAS_{i,h}, ED_{BNDi,m,h}(t), RTUED_{i,m,h}(t)) + TOL \end{array} \right\} \quad \therefore T_{h+1,0} \geq t \geq T \geq T_{h,0}
\end{array} \right\} \quad \therefore m \in FMM$$
  

$$\left. \begin{array}{l}
T5_m = \max T \quad \therefore \left\{ \begin{array}{l} s_{i,m}(t) = 1 \\ DOP_i(t) < \min(DAS_{i,h-1}, DAS_{i,h}, ED_{BNDi,m,h}(t), RTLED_{i,m,h}(t)) - TOL \end{array} \right\} \quad \therefore T_{h,0} \leq t \leq T \leq T_{h+1,0} \\
T6_m = \max T \quad \therefore \left\{ \begin{array}{l} s_{i,m}(t) = -1 \\ DOP_i(t) > \max(DAS_{i,h-1}, DAS_{i,h}, ED_{BNDi,m,h}(t), RTUED_{i,m,h}(t)) + TOL \end{array} \right\} \quad \therefore T_{h,0} \leq t \leq T \leq T_{h+1,0} \\
T7_m = \min T \quad \therefore \left\{ \begin{array}{l} s_{i,m}(t) = -1 \\ DOP_i(t) < \min(DAS_{i,h+1}, DAS_{i,h}, ED_{BNDi,m,h}(t), RTLED_{i,m,h}(t)) - TOL \end{array} \right\} \quad \therefore T_{h+1,0} \geq t \geq T \geq T_{h,0} \\
T8_m = \min T \quad \therefore \left\{ \begin{array}{l} s_{i,m}(t) = 1 \\ DOP_i(t) > \max(DAS_{i,h+1}, DAS_{i,h}, ED_{BNDi,m,h}(t), RTUED_{i,m,h}(t)) + TOL \end{array} \right\} \quad \therefore T_{h+1,0} \geq t \geq T \geq T_{h,0}
\end{array} \right\} \quad \therefore m \in RTD$$

$\therefore i \notin S_{HPD} \cup S_{TIE}$  

The 15-minute Trading Interval Reference for *TRIE*, *GTRIE*, and *LTRIE* is the one that includes  $t$  or ends at the backward terminating time going beyond hourly boundaries, calculated as follows:

$$TB_{ref,m} = \left\{ \begin{array}{l} \min \left( \begin{array}{l} \min T \quad \therefore \left\{ \begin{array}{l} s_{i,m}(t) = 1 \\ FMS_{i,h}(t) < \min(DAS_{i,h-1}, DAS_{i,h}, ED_{BNDi,m,h}(t), RTLED_{i,m,h}(t)) - TOL \end{array} \right\} \\ \min T \quad \therefore \left\{ \begin{array}{l} s_{i,m}(t) = -1 \\ FMS_{i,h}(t) > \max(DAS_{i,h-1}, DAS_{i,h}, ED_{BNDi,m,h}(t), RTUED_{i,m,h}(t)) + TOL \end{array} \right\} \end{array} \right) \quad \therefore T_{h,0} \geq t \geq T \geq T_0 \quad \therefore m \in FMM \\ \min \left( \begin{array}{l} \min T \quad \therefore \left\{ \begin{array}{l} s_{i,m}(t) = 1 \\ DOP_i(t) < \min(DAS_{i,h-1}, DAS_{i,h}, ED_{BNDi,m,h}(t), RTLED_{i,m,h}(t)) - TOL \end{array} \right\} \\ \min T \quad \therefore \left\{ \begin{array}{l} s_{i,m}(t) = -1 \\ DOP_i(t) > \max(DAS_{i,h-1}, DAS_{i,h}, ED_{BNDi,m,h}(t), RTUED_{i,m,h}(t)) + TOL \end{array} \right\} \end{array} \right) \quad \therefore T_{h,0} \geq t \geq T \geq T_0 \quad \therefore m \in RTD \end{array} \right.$$

Note:  $TB_{ref,m}$  can be different between FMM and RTD.

The 15-minute Trading Interval Reference for *BRIE*, *GBRIE*, and *LBRIE* is the one that includes or starts at the forward terminating time going beyond hourly boundaries, calculated as follows:

$$TF_{ref,m} = \left\{ \begin{array}{l} \max \left( \begin{array}{l} \max T \quad \therefore \left\{ \begin{array}{l} s_{i,m}(t) = -1 \\ DOP_i(t) < \min(DAS_{i,h+1}, DAS_{i,h}, ED_{BNDi,m,h}(t), RTLED_{i,m,h}(t)) - TOL \end{array} \right\} \\ \max T \quad \therefore \left\{ \begin{array}{l} s_{i,m}(t) = 1 \\ DOP_i(t) > \max(DAS_{i,h+1}, DAS_{i,h}, ED_{BNDi,m,h}(t), RTUED_{i,m,h}(t)) + TOL \end{array} \right\} \end{array} \right) \quad \therefore T_{h+1,0} \leq t \leq T \leq T_N \quad \therefore m \in FMM \\ \max \left( \begin{array}{l} \max T \quad \therefore \left\{ \begin{array}{l} s_{i,m}(t) = -1 \\ DOP_i(t) < \min(DAS_{i,h+1}, DAS_{i,h}, ED_{BNDi,m,h}(t), RTLED_{i,m,h}(t)) - TOL \end{array} \right\} \\ \max T \quad \therefore \left\{ \begin{array}{l} s_{i,m}(t) = 1 \\ DOP_i(t) > \max(DAS_{i,h+1}, DAS_{i,h}, ED_{BNDi,m,h}(t), RTUED_{i,m,h}(t)) + TOL \end{array} \right\} \end{array} \right) \quad \therefore T_{h+1,0} \leq t \leq T \leq T_N \quad \therefore m \in RTD \end{array} \right.$$

Note:  $TF_{ref,m}$  can be different between FMM and RTD.

If the search reaches the end or start of the target Trading Day, it shall continue into subsequent or previous Trading Days as needed.

Note: In the above  $TB_{ref}$  and  $TF_{ref}$  formulae,  $h$  is the current hour where the conditions for the search are evaluated and it shall be decremented or incremented accordingly as the search proceeds to previous or subsequent hours.

The 15-minute mitigated Energy Bid of the 15-minute Trading Interval Reference shall be used in the settlement of Residual Imbalance Energy, except as noted in section **Error! Reference source not found.**

### C.2.1.20 De-rate Energy

The De-rate Energy is the sum of the Lower De-rate Energy due to Minimum Load overrates and the Upper De-rate Energy due to Maximum Capacity de-rates:

$$\left\{ \begin{array}{l} DRE_{i,m,h,f} = LDRE_{i,m,h,f} + UDRE_{i,m,h,f} \quad \therefore m \in FMM \\ DRE_{i,m,h,k} = LDRE_{i,m,h,k} + UDRE_{i,m,h,k} \quad \therefore m \in RTD \end{array} \right\} \therefore i \in S_{GEN} \cup S_{HPD}$$

The De-rate Energy for NGR is the sum of the Lower De-rate Energy due to GMIN/LMIN overrates and the Upper De-rate Energy due to GMAX/LMAX de-rates:

$$\left\{ \begin{array}{l} DRE_{i,m,h,f} = GLDRE_{i,m,h,f} + GUDRE_{i,m,h,f} + LLDRE_{i,m,h,f} + LUDRE_{i,m,h,f} \quad \therefore m \in FMM \\ DRE_{i,m,h,k} = GLDRE_{i,m,h,k} + GUDRE_{i,m,h,k} + LLDRE_{i,m,h,k} + LUDRE_{i,m,h,k} \quad \therefore m \in RTD \end{array} \right\} \therefore i \in S_{NGR}$$

The Lower De-rate Energy, including any overlap with LFE or BED, but excluding SRE, is calculated as follows:

$$\left\{ \begin{array}{l} LDRE_{i,m,h,f} = \int_{T_{h,f-1}}^{T_{h,f}} \frac{\max(0, \min(FMS_{i,h}(t), RTLOL_{i,m,h}(t)) - \max(ED_{BNDi,m,h}(t), RTUED_{i,m,h}(t), DASR_{i,h}(t), DAS_{i,h}(t)))}{3600} dt \quad \therefore m \in FMM \\ LDRE_{i,m,h,k} = \int_{T_{h,k-1}}^{T_{h,k}} \frac{\max(0, \min(DOP_i(t), RTLOL_{i,m,h}(t)) - \max(ED_{BNDi,m,h}(t), RTUED_{i,m,h}(t), FMSR_{i,h}(t), FMS_{i,h}(t)))}{3600} dt \quad \therefore m \in RTD \end{array} \right\} \therefore i \in S_{GEN} \cap S_{HPD}$$

$$\left\{ \begin{array}{l} LDRE_{i,m,h,f} = \left\{ \int_{T_{h,f-1}}^{T_{h,f}} \frac{\max(0, \min(FMS_{i,h}(t), RTLOL_{i,m,h}(t)) - \max(ED_{BNDi,m,h}(t), RTUED_{i,m,h}(t), DASR_{i,h}(t), DAS_{i,h}(t), SR_{i,h}(t)))}{3600} dt + \int_{T_{h,f-1}}^{T_{h,f}} \frac{\max(0, \min(FMS_{i,h}(t), RTLOL_{i,m,h}(t), DAS_{i,h}(t), SR_{i,h}(t)) - \max(ED_{BNDi,m,h}(t), RTUED_{i,m,h}(t), DASR_{i,h}(t)))}{3600} dt \right\} \therefore m \in FMM \\ LDRE_{i,m,h,k} = \left\{ \int_{T_{h,k-1}}^{T_{h,k}} \frac{\max(0, \min(DOP_i(t), RTLOL_{i,m,h}(t)) - \max(ED_{BNDi,m,h}(t), RTUED_{i,m,h}(t), FMSR_{i,h}(t), FMS_{i,h}(t)))}{3600} dt + \int_{T_{h,k-1}}^{T_{h,k}} \frac{\max(0, \min(DOP_i(t), RTLOL_{i,m,h}(t), FMS_{i,h}(t)) - \max(ED_{BNDi,m,h}(t), RTUED_{i,m,h}(t), FMSR_{i,h}(t)))}{3600} dt \right\} \therefore m \in RTD \end{array} \right\} \therefore i \in S_{GEN} - S_{HPD}$$

$$\left\{ \begin{array}{l} GLDRE_{i,m,h,f} = \left\{ \int_{T_{h,f-1}}^{T_{h,f}} \frac{\max(0, \min(FMS_{i,h}(t), GRTLOL_{i,m,h}(t)) - \max(G_{MINi}, ED_{BNDi,m,h}(t), RTUED_{i,m,h}(t), DASR_{i,h}(t), DAS_{i,h}(t), SR_{i,h}(t)))}{3600} dt + \int_{T_{h,f-1}}^{T_{h,f}} \frac{\max(0, \min(FMS_{i,h}(t), GRTLOL_{i,m,h}(t), DAS_{i,h}(t), SR_{i,h}(t)) - \max(G_{MINi}, ED_{BNDi,m,h}(t), RTUED_{i,m,h}(t), DASR_{i,h}(t)))}{3600} dt \right\} \therefore m \in FMM \\ GLDRE_{i,m,h,k} = \left\{ \int_{T_{h,k-1}}^{T_{h,k}} \frac{\max(0, \min(DOP_i(t), GRTLOL_{i,m,h}(t)) - \max(G_{MINi}, ED_{BNDi,m,h}(t), RTUED_{i,m,h}(t), FMSR_{i,h}(t), FMS_{i,h}(t)))}{3600} dt + \int_{T_{h,k-1}}^{T_{h,k}} \frac{\max(0, \min(DOP_i(t), GRTLOL_{i,m,h}(t), FMS_{i,h}(t)) - \max(G_{MINi}, ED_{BNDi,m,h}(t), RTUED_{i,m,h}(t), FMSR_{i,h}(t)))}{3600} dt \right\} \therefore m \in RTD \end{array} \right\} \therefore i \in S_{NGR}$$

$$\begin{aligned}
 LLDRE_{i,m,h,f} &= \left\{ \begin{aligned} &\int_{T_{h,f-1}}^{T_{h,f}} \frac{\min(0, \max(FMS_{i,h}(t), LRTL_{i,m,h}(t)) - \min(L_{MINi}, ED_{BNDi,m,h}(t), RTLED_{i,m,h}(t), DASR_{i,h}(t), DAS_{i,h}(t), SR_{i,h}(t)))}{3600} dt + \\ &\int_{T_{h,f-1}}^{T_{h,f}} \frac{\min(0, \max(FMS_{i,h}(t), LRTL_{i,m,h}(t), DAS_{i,h}(t), SR_{i,h}(t)) - \min(L_{MINi}, ED_{BNDi,m,h}(t), RTLED_{i,m,h}(t), DASR_{i,h}(t)))}{3600} dt \end{aligned} \right\} \begin{array}{l} \therefore m \in FMM \\ \therefore i \in S_{NGR} \end{array} \\
 LLDRE_{i,m,h,k} &= \left\{ \begin{aligned} &\int_{T_{h,k-1}}^{T_{h,k}} \frac{\min(0, \max(DOP_i(t), LRTL_{i,m,h}(t)) - \min(L_{MINi}, ED_{BNDi,m,h}(t), RTLED_{i,m,h}(t), FMSR_{i,h}(t), FMS_{i,h}(t)))}{3600} dt + \\ &\int_{T_{h,k-1}}^{T_{h,k}} \frac{\min(0, \max(DOP_i(t), LRTL_{i,m,h}(t), FMS_{i,h}(t)) - \min(L_{MINi}, ED_{BNDi,m,h}(t), RTLED_{i,m,h}(t), FMSR_{i,h}(t)))}{3600} dt \end{aligned} \right\} \begin{array}{l} \therefore m \in RTD \\ \therefore i \in S_{NGR} \end{array}
 \end{aligned}$$

The Upper De-rate Energy, including any overlap with LFE or BED, but excluding SRE, is calculated as follows:

$$\begin{aligned}
 \left\{ \begin{aligned} UDRE_{i,m,h,f} &= \int_{T_{h,f-1}}^{T_{h,f}} \frac{\min(0, \max(FMS_{i,h}(t), RTUOL_{i,m,h}(t)) - \min(ED_{BNDi,m,h}(t), RTLED_{i,m,h}(t), DASR_{i,h}(t), DAS_{i,h}(t)))}{3600} dt \quad \therefore m \in FMM \\ UDRE_{i,m,h,k} &= \int_{T_{h,k-1}}^{T_{h,k}} \frac{\min(0, \max(DOP_i(t), RTUOL_{i,m,h}(t)) - \min(ED_{BNDi,m,h}(t), RTLED_{i,m,h}(t), FMSR_{i,h}(t), FMS_{i,h}(t)))}{3600} dt \quad \therefore m \in RTD \end{aligned} \right\} \therefore i \in S_{GEN} \cap S_{HPD}
 \end{aligned}$$

$$\begin{aligned}
 UDRE_{i,m,h,f} &= \left\{ \begin{array}{l} \int_{T_{h,f-1}}^{T_{h,f}} \frac{\min(0, \max(FMS_{i,h}(t), RTUOL_{i,m,h}(t)) - \min(ED_{BNDi,m,h}(t), RTLED_{i,m,h}(t), DASR_{i,h}(t), DAS_{i,h}, SR_{i,h}(t)))}{3600} dt + \\ \int_{T_{h,f-1}}^{T_{h,f}} \frac{\min(0, \max(FMS_{i,h}(t), RTUOL_{i,m,h}(t), DAS_{i,h}, SR_{i,h}(t)) - \min(ED_{BNDi,m,h}(t), RTLED_{i,m,h}(t), DASR_{i,h}(t)))}{3600} dt \end{array} \right\} \begin{array}{l} \therefore m \in FMM \\ \therefore i \in S_{GEN} - S_{HPD} \end{array} \\
 UDRE_{i,m,h,k} &= \left\{ \begin{array}{l} \int_{T_{h,k-1}}^{T_{h,k}} \frac{\min(0, \max(DOP_i(t), RTUOL_{i,m,h}(t)) - \min(ED_{BNDi,m,h}(t), RTLED_{i,m,h}(t), FMSR_{i,h}(t), FMS_{i,h}(t)))}{3600} dt + \\ \int_{T_{h,k-1}}^{T_{h,k}} \frac{\min(0, \max(DOP_i(t), RTUOL_{i,m,h}(t), FMS_{i,h}(t)) - \min(ED_{BNDi,m,h}(t), RTLED_{i,m,h}(t), FMSR_{i,h}(t)))}{3600} dt \end{array} \right\} \begin{array}{l} \therefore m \in RTD \\ \therefore i \in S_{GEN} - S_{HPD} \end{array}
 \end{aligned}$$

$$\begin{aligned}
 GUDRE_{i,m,h,f} &= \left\{ \begin{array}{l} \int_{T_{h,f-1}}^{T_{h,f}} \frac{\min(0, \max(FMS_{i,h}(t), GRTUOL_{i,m,h}(t)) - \min(ED_{BNDi,m,h}(t), RTLED_{i,m,h}(t), DASR_{i,h}(t), DAS_{i,h}, SR_{i,h}(t)))}{3600} dt + \\ \int_{T_{h,f-1}}^{T_{h,f}} \frac{\min(0, \max(FMS_{i,h}(t), GRTUOL_{i,m,h}(t), DAS_{i,h}, SR_{i,h}(t)) - \min(ED_{BNDi,m,h}(t), RTLED_{i,m,h}(t), DASR_{i,h}(t)))}{3600} dt \end{array} \right\} \begin{array}{l} \therefore m \in FMM \\ \therefore i \in S_{NGR} \end{array} \\
 GUDRE_{i,m,h,k} &= \left\{ \begin{array}{l} \int_{T_{h,k-1}}^{T_{h,k}} \frac{\min(0, \max(DOP_i(t), GRTUOL_{i,m,h}(t)) - \min(ED_{BNDi,m,h}(t), RTLED_{i,m,h}(t), FMSR_{i,h}(t), FMS_{i,h}(t)))}{3600} dt + \\ \int_{T_{h,k-1}}^{T_{h,k}} \frac{\min(0, \max(DOP_i(t), GRTUOL_{i,m,h}(t), FMS_{i,h}(t)) - \min(ED_{BNDi,m,h}(t), RTLED_{i,m,h}(t), FMSR_{i,h}(t)))}{3600} dt \end{array} \right\} \begin{array}{l} \therefore m \in RTD \\ \therefore i \in S_{NGR} \end{array}
 \end{aligned}$$



$$\begin{aligned}
 LUDRE_{i,m,h,f} &= \left\{ \begin{aligned} &\int_{T_{h,f-1}}^{T_{h,f}} \frac{\max(0, \min(FMS_{i,h}(t), LRTUOL_{i,m,h}(t)) - \max(ED_{BNDi,m,h}(t), RTUED_{i,m,h}(t), DASR_{i,h}(t), DAS_{i,h}(t), SR_{i,h}(t)))}{3600} dt + \\ &\int_{T_{h,f-1}}^{T_{h,f}} \frac{\max(0, \min(FMS_{i,h}(t), LRTUOL_{i,m,h}(t), DAS_{i,h}(t), SR_{i,h}(t)) - \max(ED_{BNDi,m,h}(t), RTUED_{i,m,h}(t), DASR_{i,h}(t)))}{3600} dt \end{aligned} \right\} \begin{array}{l} \therefore m \in FMM \\ \therefore i \in S_{NGR} \end{array} \\
 LUDRE_{i,m,h,k} &= \left\{ \begin{aligned} &\int_{T_{h,k-1}}^{T_{h,k}} \frac{\max(0, \min(DOP_i(t), LRTUOL_{i,m,h}(t)) - \max(ED_{BNDi,m,h}(t), RTUED_{i,m,h}(t), FMSR_{i,h}(t), FMS_{i,h}(t)))}{3600} dt + \\ &\int_{T_{h,k-1}}^{T_{h,k}} \frac{\max(0, \min(DOP_i(t), LRTUOL_{i,m,h}(t), FMS_{i,h}(t)) - \max(ED_{BNDi,m,h}(t), RTUED_{i,m,h}(t), FMSR_{i,h}(t)))}{3600} dt \end{aligned} \right\} \begin{array}{l} \therefore m \in RTD \\ \therefore i \in S_{NGR} \end{array}
 \end{aligned}$$

### C.2.1.21 Exceptional Dispatch Energy

The Exceptional Dispatch Energy, including any overlap with LFE or BED, but excluding SRE and RTPe, is calculated as follows:

$$EDE_{i,m,f} = \left\{ \begin{aligned} &\int_{T_{h,f-1}}^{T_{h,f}} \frac{\max(0, \min(FMS_{i,h}(t), ED_{BNDi,m,h}(t)) - \max(0, RTUED_{i,m,h}(t), DASR_{i,h}(t), DAS_{i,h}(t)))}{3600} dt \quad \therefore ED_{BNDi,h}(t) > DASR_{i,h}(t) \\ &\int_{T_{h,f-1}}^{T_{h,f}} \frac{\min(0, \max(0, FMS_{i,h}(t), ED_{BNDi,m,h}(t)) - \min(RTLED_{i,m,h}(t), DASR_{i,h}(t), DAS_{i,h}(t)))}{3600} dt \quad \therefore ED_{BNDi,h}(t) < DASR_{i,h}(t) \end{aligned} \right\} \therefore m \in FMM, \therefore i \in S_{HPD}$$

$$EDE_{i,m,h,k} = \left\{ \begin{array}{l} \int_{T_{h,k-1}}^{T_{h,k}} \frac{\max(0, \min(DOP_i(t), ED_{BNDi,m,h}(t)) - \max(0, RTUED_{i,m,h}(t), FMSR_{i,h}(t), FMS_{i,h}(t)))}{3600} dt \quad \because ED_{BNDi,h}(t) > FMSR_{i,h}(t) \\ \int_{T_{h,k-1}}^{T_{h,k}} \frac{\min(0, \max(0, DOP_i(t), ED_{BNDi,m,h}(t)) - \min(RTLED_{i,m,h}(t), FMSR_{i,h}(t), FMS_{i,h}(t)))}{3600} dt \quad \because ED_{BNDi,h}(t) < FMSR_{i,h}(t) \end{array} \right\} \quad \because m \in RTD, \therefore i \in S_{HPD}$$

∪ SHDR

$$EDE_{i,m,h,f} = \left\{ \begin{array}{l} \int_{T_{h,f-1}}^{T_{h,f}} \frac{\max(0, \min(FMS_{i,h}(t), ED_{BNDi,m,h}(t)) - \max(0, RTUED_{i,m,h}(t), DASR_{i,h}(t), DAS_{i,h}(t), SR_{i,h}(t)))}{3600} dt + \\ \int_{T_{h,f-1}}^{T_{h,f}} \frac{\max(0, \min(FMS_{i,h}(t), ED_{BNDi,m,h}(t), DAS_{i,h}, SR_{i,h}(t)) - \max(0, RTUED_{i,m,h}(t), DASR_{i,h}(t)))}{3600} dt \quad \because ED_{BNDi,m,h}(t) > DASR_{i,h}(t) \\ \int_{T_{h,f-1}}^{T_{h,f}} \frac{\min(0, \max(0, FMS_{i,h}(t), ED_{BNDi,m,h}(t)) - \min(RTLED_{i,m,h}(t), DASR_{i,h}(t), DAS_{i,h}, SR_{i,h}(t)))}{3600} dt + \\ \int_{T_{h,f-1}}^{T_{h,f}} \frac{\min(0, \max(0, FMS_{i,h}(t), ED_{BNDi,m,h}(t), DAS_{i,h}, SR_{i,h}(t)) - \min(RTLED_{i,m,h}(t), DASR_{i,h}(t)))}{3600} dt \quad \because ED_{BNDi,m,h}(t) < DASR_{i,h}(t) \end{array} \right\} \quad \because m \in FMM, \therefore i \notin S_{NGR} \cup S_{HPD}$$

$$EDE_{i,m,h,k} = \left\{ \begin{array}{l} \int_{T_{h,k-1}}^{T_{h,k}} \frac{\max(0, \min(DOP_i(t), ED_{BNDi,m,h}(t)) - \max(0, RTUED_{i,m,h}(t), FMSR_{i,h}(t), FMS_{i,h}(t)))}{3600} dt + \\ \int_{T_{h,k-1}}^{T_{h,k}} \frac{\max(0, \min(DOP_i(t), ED_{BNDi,m,h}(t), FMS_{i,h}(t)) - \max(0, RTUED_{i,m,h}(t), FMSR_{i,h}(t)))}{3600} dt \quad \because ED_{BNDi,m,h}(t) > FMSR_{i,h}(t) \\ \int_{T_{h,k-1}}^{T_{h,k}} \frac{\min(0, \max(0, DOP_i(t), ED_{BNDi,m,h}(t)) - \min(RTLED_{i,m,h}(t), FMSR_{i,h}(t), FMS_{i,h}(t)))}{3600} dt + \\ \int_{T_{h,k-1}}^{T_{h,k}} \frac{\min(0, \max(0, DOP_i(t), ED_{BNDi,m,h}(t), FMS_{i,h}(t)) - \min(RTLED_{i,m,h}(t), FMSR_{i,h}(t)))}{3600} dt \quad \because ED_{BNDi,m,h}(t) < FMSR_{i,h}(t) \end{array} \right\} \quad \because m \in RTD, \therefore i \notin S_{NGR} \cup S_{HPD}$$

$$\begin{aligned}
EDE_{i,m,h,f} = & \left\{ \begin{array}{l}
\int_{T_{h,f-1}}^{T_{h,f}} \frac{\max(0, \min(FMS_{i,h}(t), ED_{BNDi,m,h}(t)) - \max(G_{MINi}, RTUED_{i,m,h}(t), DASR_{i,h}(t), DAS_{i,h}, SR_{i,h}(t)))}{3600} dt + \\
\int_{T_{h,f-1}}^{T_{h,f}} \frac{\max(0, \min(FMS_{i,h}(t), ED_{BNDi,m,h}(t), DAS_{i,h}, SR_{i,h}(t)) - \max(G_{MINi}, RTUED_{i,m,h}(t), DASR_{i,h}(t)))}{3600} dt + \\
\int_{T_{h,f-1}}^{T_{h,f}} \frac{\max(0, \min(0, FMS_{i,h}(t), ED_{BNDi,m,h}(t)) - \max(RTUED_{i,m,h}(t), DASR_{i,h}(t), DAS_{i,h}, SR_{i,h}(t)))}{3600} dt + \\
\int_{T_{h,f-1}}^{T_{h,f}} \frac{\max(0, \min(0, FMS_{i,h}(t), ED_{BNDi,m,h}(t), DAS_{i,h}, SR_{i,h}(t)) - \max(RTUED_{i,m,h}(t), DASR_{i,h}(t)))}{3600} dt \\
\int_{T_{h,f-1}}^{T_{h,f}} \frac{\min(0, \max(FMS_{i,h}(t), ED_{BNDi,m,h}(t)) - \min(L_{MINi}, RTLED_{i,m,h}(t), DASR_{i,h}(t), DAS_{i,h}, SR_{i,h}(t)))}{3600} dt + \\
\int_{T_{h,f-1}}^{T_{h,f}} \frac{\min(0, \max(FMS_{i,h}(t), ED_{BNDi,m,h}(t), DAS_{i,h}, SR_{i,h}(t)) - \min(L_{MINi}, RTLED_{i,m,h}(t), DASR_{i,h}(t)))}{3600} dt + \\
\int_{T_{h,f-1}}^{T_{h,f}} \frac{\min(0, \max(0, FMS_{i,h}(t), ED_{BNDi,m,h}(t)) - \min(RTLED_{i,m,h}(t), DASR_{i,h}(t), DAS_{i,h}, SR_{i,h}(t)))}{3600} dt + \\
\int_{T_{h,f-1}}^{T_{h,f}} \frac{\min(0, \max(0, FMS_{i,h}(t), ED_{BNDi,m,h}(t), DAS_{i,h}, SR_{i,h}(t)) - \min(RTLED_{i,m,h}(t), DASR_{i,h}(t)))}{3600} dt
\end{array} \right\}
\end{aligned}$$

$\left. \begin{array}{l} \because ED_{BNDi,m,h}(t) > DASR_{i,h}(t) \\ \\ \\ \\ \\ \\ \because ED_{BNDi,m,h}(t) < DASR_{i,h}(t) \end{array} \right\} \therefore m \in FMM, \therefore i \in S_{NGR}$

$$\begin{aligned}
EDE_{i,m,h,k} = & \left. \begin{aligned}
& \int_{T_{h,k-1}}^{T_{h,k}} \frac{\max(0, \min(DOP_i(t), ED_{BNDi,m,h}(t)) - \max(G_{MINi}, RTUED_{i,m,h}(t), FMSR_{i,h}(t), FMS_{i,h}(t)))}{3600} dt + \\
& \int_{T_{h,k-1}}^{T_{h,k}} \frac{\max(0, \min(DOP_i(t), ED_{BNDi,m,h}(t), FMS_{i,h}(t)) - \max(G_{MINi}, RTUED_{i,m,h}(t), FMSR_{i,h}(t)))}{3600} dt + \\
& \int_{T_{h,k-1}}^{T_{h,k}} \frac{\max(0, \min(0, DOP_i(t), ED_{BNDi,m,h}(t)) - \max(RTUED_{i,m,h}(t), FMSR_{i,h}(t), FMS_{i,h}(t)))}{3600} dt + \\
& \int_{T_{h,k-1}}^{T_{h,k}} \frac{\max(0, \min(0, DOP_i(t), ED_{BNDi,m,h}(t), FMS_{i,h}(t)) - \max(RTUED_{i,m,h}(t), FMSR_{i,h}(t)))}{3600} dt \\
& \int_{T_{h,k-1}}^{T_{h,k}} \frac{\min(0, \max(DOP_i(t), ED_{BNDi,m,h}(t)) - \min(L_{MINi}, RTLED_{i,m,h}(t), FMSR_{i,h}(t), FMS_{i,h}(t)))}{3600} dt + \\
& \int_{T_{h,k-1}}^{T_{h,k}} \frac{\min(0, \max(DOP_i(t), ED_{BNDi,m,h}(t), FMS_{i,h}(t)) - \min(L_{MINi}, RTLED_{i,m,h}(t), FMSR_{i,h}(t)))}{3600} dt + \\
& \int_{T_{h,k-1}}^{T_{h,k}} \frac{\min(0, \max(0, DOP_i(t), ED_{BNDi,m,h}(t)) - \min(RTLED_{i,m,h}(t), FMSR_{i,h}(t), FMS_{i,h}(t)))}{3600} dt + \\
& \int_{T_{h,k-1}}^{T_{h,k}} \frac{\min(0, \max(0, DOP_i(t), ED_{BNDi,m,h}(t), FMS_{i,h}(t)) - \min(RTLED_{i,m,h}(t), FMSR_{i,h}(t)))}{3600} dt
\end{aligned} \right\} \begin{aligned}
& \because ED_{BNDi,m,h}(t) > FMSR_{i,h}(t) \\
& \\
& \\
& \\
& \\
& \\
& \because ED_{BNDi,m,h}(t) < FMSR_{i,h}(t)
\end{aligned} \left. \vphantom{\int_{T_{h,k-1}}^{T_{h,k}}} \right\} \because m \in RTD, \therefore i \in S_{NGR}
\end{aligned}$$

### C.2.1.22 Optimal Energy

Any Instructed Imbalance Energy that remains unaccounted is Optimal Energy:

$$\left. \begin{aligned}
OE_{i,m,h,f} &= IIE_{i,m,h,f} - BED_{i,m,h,f} - SRE_{i,h,f} - LFE_{i,m,h,f} - RTPE_{i,m,h,f} - RTMLE_{i,m,h,f} - RED_{i,m,h,f} - RIE_{i,m,h,f} - DRE_{i,m,h,f} - EDE_{i,m,h,f} & \because m \in FMM \\
OE_{i,m,h,k} &= IIE_{i,m,h,k} - BED_{i,m,h,k} - LFE_{i,m,h,k} - RTPE_{i,m,h,k} - RTMLE_{i,m,h,k} - RED_{i,m,h,k} - RIE_{i,m,h,k} - DRE_{i,m,h,k} - EDE_{i,m,h,k} & \because m \in RTD
\end{aligned} \right\} \because i \notin S_{NGR}$$

$$\left. \begin{aligned}
OE_{i,m,h,f} &= IIE_{i,m,h,f} - BED_{i,m,h,f} - SRE_{i,h,f} - LFE_{i,m,h,f} - RTMGE_{i,m,h,f} - RTMLE_{i,m,h,f} - RED_{i,m,h,f} - RIE_{i,m,h,f} - DRE_{i,m,h,f} - EDE_{i,m,h,f} & \because m \in FMM \\
OE_{i,m,h,k} &= IIE_{i,m,h,k} - BED_{i,m,h,k} - LFE_{i,m,h,k} - RTMGE_{i,m,h,k} - RTMLE_{i,m,h,k} - RED_{i,m,h,k} - RIE_{i,m,h,k} - DRE_{i,m,h,k} - EDE_{i,m,h,k} & \because m \in RTD
\end{aligned} \right\} \because i \in S_{NGR}$$

For Non-Dynamic System Resources, and Proxy Demand Resources electing to be dispatched in Hourly Blocks or fifteen (15) minute intervals, the Optimal Energy is calculated as the sum of the extra-marginal and infra-marginal portions as follows:

$$OE_{i,m,h,f} = \left\{ \begin{array}{l} \int_{T_{h,f-1}}^{T_{h,f}} \frac{\max(0, FMS_{i,h}(t) - \max(0, RTLOL_{i,m,h}(t), ED_{BNDi,m,h}(t), RTUED_{i,m,h}(t), DASR_{i,h}(t)))}{3600} dt + \\ \int_{T_{h,f-1}}^{T_{h,f}} \frac{\max(0, \min(FMS_{i,h}(t), RTUED_{i,m,h}(t)) - \max(P_{MINi}, DASR_{i,h}(t)))}{3600} dt + \\ \int_{T_{h,f-1}}^{T_{h,f}} \frac{\min(0, \max(0, FMS_{i,h}(t)) - \min(RTUOL_{i,m,h}(t), ED_{BNDi,m,h}(t), RTLED_{i,m,h}(t), DASR_{i,h}(t)))}{3600} dt + \\ \int_{T_{h,f-1}}^{T_{h,f}} \frac{\min(0, \max(0, FMS_{i,h}(t), RTLED_{i,m,h}(t)) - DASR_{i,h}(t))}{3600} dt \end{array} \right\} \begin{array}{l} \therefore m \in FMM \\ \therefore i \in S_{HPD} \end{array}$$

$$OE_{i,m,h,k} = \left\{ \begin{array}{l} \int_{T_{h,k-1}}^{T_{h,k}} \frac{\max(0, DOP_i(t) - \max(0, RTLOL_{i,m,h}(t), ED_{BNDi,m,h}(t), RTUED_{i,m,h}(t), FMSR_{i,h}(t)))}{3600} dt + \\ \int_{T_{h,k-1}}^{T_{h,k}} \frac{\max(0, \min(DOP_i(t), RTUED_{i,m,h}(t)) - \max(P_{MINi}, FMSR_{i,h}(t)))}{3600} dt + \\ \int_{T_{h,k-1}}^{T_{h,k}} \frac{\min(0, \max(0, DOP_i(t)) - \min(RTUOL_{i,m,h}(t), ED_{BNDi,m,h}(t), RTLED_{i,m,h}(t), FMSR_{i,h}(t)))}{3600} dt + \\ \int_{T_{h,k-1}}^{T_{h,k}} \frac{\min(0, \max(0, DOP_i(t), RTLED_{i,m,h}(t)) - FMSR_{i,h}(t))}{3600} dt \end{array} \right\} \begin{array}{l} \therefore m \in RTD \\ \therefore i \in S_{HPD} \end{array}$$



For non-generator resources (NGRs), for which SRE/RED/RIE may exist, the Optimal Energy is calculated as the sum of the extra-marginal and infra-marginal portions that may overlap, but excluding SRE/RED/RIE and RTPE. The Non-overlapping Optimal Energy is calculated as follows:

$$\begin{aligned}
 GNOE_{i,m,h,f} &= \left. \begin{aligned}
 &\int_{\max(T_{h,f-1}, T2_m, T6_m)}^{\min(T_{h,f}, T4_m, T8_m)} \frac{\max(0, FMS_{i,h}(t) - \max(GRTL0L_{i,m,h}(t), ED_{BNDi,m,h}(t), RTUED_{i,m,h}(t), DASR_{i,h}(t), DAS_{i,h}(t), SR_{i,h}(t)))}{3600} dt + \\
 &\int_{T_{h,f-1}}^{T_{h,k}} \frac{\max(0, \min(FMS_{i,h}(t), RTUED_{i,m,h}(t)) - \max(G_{MINi}, DASR_{i,m,h}(t), DAS_{i,h}(t), SR_{i,h}(t)))}{3600} dt + \\
 &\int_{\max(T_{h,f-1}, T1_m, T5_m)}^{\min(T_{h,f}, T3_m, T7_m)} \frac{\min(0, \max(G_{MINi}, FMS_{i,h}(t)) - \min(GRTUOL_{i,m,h}(t), ED_{BNDi,m,h}(t), RTLED_{i,m,h}(t), DASR_{i,h}(t), DAS_{i,h}(t), SR_{i,h}(t)))}{3600} dt + \\
 &\int_{T_{h,f-1}}^{T_{h,f}} \frac{\min(0, \max(G_{MINi}, FMS_{i,h}(t), RTLED_{i,m,h}(t)) - \min(DASR_{i,h}(t), DAS_{i,h}(t), SR_{i,h}(t)))}{3600} dt
 \end{aligned} \right\} \begin{array}{l} \therefore m \in FMM \\ \therefore i \in S_{NGR} \end{array} \\
 \\
 GNOE_{i,m,h,k} &= \left. \begin{aligned}
 &\int_{\max(T_{h,k-1}, T2_m, T6_m)}^{\min(T_{h,k}, T4_m, T8_m)} \frac{\max(0, DOP_i(t) - \max(GRTL0L_{i,m,h}(t), ED_{BNDi,m,h}(t), RTUED_{i,m,h}(t), FMSR_{i,h}(t), FMS_{i,h}(t)))}{3600} dt + \\
 &\int_{T_{h,k-1}}^{T_{h,k}} \frac{\max(0, \min(DOP_i(t), RTUED_{i,m,h}(t)) - \max(G_{MINi}, FMSR_{i,m,h}(t), FMS_{i,h}(t)))}{3600} dt + \\
 &\int_{\max(T_{h,k-1}, T1_m, T5_m)}^{\min(T_{h,k}, T3_m, T7_m)} \frac{\min(0, \max(G_{MINi}, DOP_i(t)) - \min(GRTUOL_{i,m,h}(t), ED_{BNDi,m,h}(t), RTLED_{i,m,h}(t), FMSR_{i,h}(t), FMS_{i,h}(t)))}{3600} dt + \\
 &\int_{T_{h,k-1}}^{T_{h,k}} \frac{\min(0, \max(G_{MINi}, DOP_i(t), RTLED_{i,m,h}(t)) - \min(FMSR_{i,h}(t), FMS_{i,h}(t)))}{3600} dt
 \end{aligned} \right\} \begin{array}{l} \therefore m \in RTD \\ \therefore i \in S_{NGR} \end{array}
 \end{aligned}$$

$$\begin{aligned}
 LNOE_{i,m,h,f} &= \left\{ \begin{aligned} &\int_{\max(T_{h,f-1}, T_{2m}, T_{6m})}^{\min(T_{h,f}, T_{4m}, T_{8m})} \frac{\min(0, FMS_{i,h}(t) - \min(LRTL_{i,m,h}(t), ED_{BNDi,m,h}(t), RTLED_{i,m,h}(t), DASR_{i,h}(t), DAS_{i,h}, SR_{i,h}(t)))}{3600} dt + \\ &\int_{T_{h,f-1}}^{T_{h,f}} \frac{\min(0, \max(FMS_{i,h}(t), RTLED_{i,m,h}(t)) - \min(L_{MINi}, DASR_{i,h}(t), DAS_{i,h}, SR_{i,h}(t)))}{3600} dt + \\ &\int_{\max(T_{h,f-1}, T_{1m}, T_{5m})}^{\min(T_{h,f}, T_{3m}, T_{7m})} \frac{\max(0, \min(L_{MINi}, FMS_{i,h}(t)) - \max(LRTUOL_{i,m,h}(t), ED_{BNDi,m,h}(t), RTUED_{i,m,h}(t), DASR_{i,h}(t), DAS_{i,h}, SR_{i,h}(t)))}{3600} dt + \\ &\int_{T_{h,f-1}}^{T_{h,f}} \frac{\max(0, \min(L_{MINi}, FMS_{i,h}(t), RTUED_{i,m,h}(t)) - \max(DASR_{i,h}(t), DAS_{i,h}, SR_{i,h}(t)))}{3600} dt \end{aligned} \right\} \begin{array}{l} \therefore m \in FMM \\ \therefore i \in S_{NGR} \end{array} \\
 LNOE_{i,m,h,k} &= \left\{ \begin{aligned} &\int_{\max(T_{h,k-1}, T_{2m}, T_{6m})}^{\min(T_{h,k}, T_{4m}, T_{8m})} \frac{\min(0, DOP_i(t) - \min(LRTL_{i,m,h}(t), ED_{BNDi,m,h}(t), RTLED_{i,m,h}(t), FMSR_{i,h}(t), FMS_{i,h}(t)))}{3600} dt + \\ &\int_{T_{h,k-1}}^{T_{h,k}} \frac{\min(0, \max(DOP_i(t), RTLED_{i,m,h}(t)) - \min(L_{MINi}, FMSR_{i,h}(t), FMS_{i,h}(t)))}{3600} dt + \\ &\int_{\max(T_{h,k-1}, T_{1m}, T_{5m})}^{\min(T_{h,k}, T_{3m}, T_{7m})} \frac{\max(0, \min(L_{MINi}, DOP_i(t)) - \max(LRTUOL_{i,m,h}(t), ED_{BNDi,m,h}(t), RTUED_{i,m,h}(t), FMSR_{i,h}(t), FMS_{i,h}(t)))}{3600} dt + \\ &\int_{T_{h,k-1}}^{T_{h,k}} \frac{\max(0, \min(L_{MINi}, DOP_i(t), RTUED_{i,m,h}(t)) - \max(FMSR_{i,h}(t), FMS_{i,h}(t)))}{3600} dt \end{aligned} \right\} \begin{array}{l} \therefore m \in RTD \\ \therefore i \in S_{NGR} \end{array}
 \end{aligned}$$

The Overlapping Optimal Energy, which may exist for Load Following Resources, is calculated as follows:



$$\begin{aligned}
 OOE_{i,m,h,f} &= \left\{ \begin{aligned} &\int_{T_{h,f-1}}^{T_{h,f}} \frac{\max(0, \min(FMS_{i,h}(t), DAS_{i,h}, SR_{i,h}(t)) - \max(0, RTLOL_{i,m,h}(t), ED_{BNDi,m,h}(t), RTUED_{i,m,h}(t), DASR_{i,h}(t)))}{3600} dt + \\ &\int_{T_{h,f-1}}^{T_{h,f}} \frac{\max(0, \min(FMS_{i,h}(t), RTUED_{i,m,h}(t), DAS_{i,h}, SR_{i,h}(t)) - \max(P_{MINi}, DASR_{i,h}(t)))}{3600} dt + \\ &\int_{T_{h,f-1}}^{T_{h,f}} \frac{\min(0, \max(0, FMS_{i,h}(t), DAS_{i,h}, SR_{i,h}(t)) - \min(RTUOL_{i,m,h}(t), ED_{BNDi,m,h}(t), RTLED_{i,m,h}(t), DASR_{i,h}(t)))}{3600} dt + \\ &\int_{T_{h,f-1}}^{T_{h,f}} \frac{\min(0, \max(0, FMS_{i,h}(t), RTLED_{i,m,h}(t), DAS_{i,h}, SR_{i,h}(t)) - DASR_{i,h}(t))}{3600} dt \end{aligned} \right\} \begin{array}{l} \therefore m \in FMM \\ \therefore i \in S_{MSS} - S_{NGR} \end{array} \\
 OOE_{i,m,h,k} &= \left\{ \begin{aligned} &\int_{T_{h,k-1}}^{T_{h,k}} \frac{\max(0, \min(DOP_i(t), FMS_{i,h}(t)) - \max(0, RTLOL_{i,m,h}(t), ED_{BNDi,m,h}(t), RTUED_{i,m,h}(t), FMSR_{i,h}(t)))}{3600} dt + \\ &\int_{T_{h,k-1}}^{T_{h,k}} \frac{\max(0, \min(DOP_i(t), RTUED_{i,m,h}(t), FMS_{i,h}(t)) - \max(P_{MINi}, FMSR_{i,h}(t)))}{3600} dt + \\ &\int_{T_{h,k-1}}^{T_{h,k}} \frac{\min(0, \max(0, DOP_i(t), FMS_{i,h}(t)) - \min(RTUOL_{i,m,h}(t), ED_{BNDi,m,h}(t), RTLED_{i,m,h}(t), FMSR_{i,h}(t)))}{3600} dt + \\ &\int_{T_{h,k-1}}^{T_{h,k}} \frac{\min(0, \max(0, DOP_i(t), RTLED_{i,m,h}(t), FMS_{i,h}(t)) - FMSR_{i,h}(t))}{3600} dt \end{aligned} \right\} \begin{array}{l} \therefore m \in RTD \\ \therefore i \in S_{MSS} - S_{NGR} \end{array}
 \end{aligned}$$

The Overlapping Optimal Energy, which may exist for Non-Generator Resources, is calculated as follows:

$$\begin{aligned}
 GOOE_{i,m,h,f} &= \left\{ \begin{aligned} &\int_{T_{h,f-1}}^{T_{h,f}} \frac{\max(0, \min(FMS_{i,h}(t), DAS_{i,h}, SR_{i,h}(t)) - \max(GRTLLOL_{i,m,h}(t), ED_{BNDi,m,h}(t), RTUED_{i,m,h}(t), DASR_{i,h}(t)))}{3600} dt + \\ &\int_{T_{h,f-1}}^{T_{h,f}} \frac{\max(0, \min(FMS_{i,h}(t), RTUED_{i,m,h}(t), DAS_{i,h}, SR_{i,h}(t)) - \max(G_{MINi}, DASR_{i,m,h}(t)))}{3600} dt + \\ &\int_{T_{h,f-1}}^{T_{h,f}} \frac{\min(0, \max(G_{MINi}, FMS_{i,h}(t), DAS_{i,h}, SR_{i,h}(t)) - \min(GRTUOL_{i,m,h}(t), ED_{BNDi,m,h}(t), RTLED_{i,m,h}(t), DASR_{i,m,h}(t)))}{3600} dt + \\ &\int_{T_{h,f-1}}^{T_{h,f}} \frac{\min(0, \max(G_{MINi}, FMS_{i,h}(t), RTLED_{i,m,h}(t), DAS_{i,h}, SR_{i,h}(t)) - DASR_{i,m,h}(t))}{3600} dt \end{aligned} \right\} \begin{array}{l} \therefore m \in FMM \\ \therefore i \in S_{MSS} - S_{NGR} \end{array} \\
 \\
 GOOE_{i,m,h,k} &= \left\{ \begin{aligned} &\int_{T_{h,k-1}}^{T_{h,k}} \frac{\max(0, \min(DOP_i(t), FMS_{i,h}(t)) - \max(GRTLLOL_{i,m,h}(t), ED_{BNDi,m,h}(t), RTUED_{i,m,h}(t), FMSR_{i,h}(t)))}{3600} dt + \\ &\int_{T_{h,k-1}}^{T_{h,k}} \frac{\max(0, \min(DOP_i(t), RTUED_{i,m,h}(t), FMS_{i,h}(t)) - \max(G_{MINi}, FMSR_{i,m,h}(t)))}{3600} dt + \\ &\int_{T_{h,k-1}}^{T_{h,k}} \frac{\min(0, \max(G_{MINi}, DOP_i(t), FMS_{i,h}(t)) - \min(GRTUOL_{i,m,h}(t), ED_{BNDi,m,h}(t), RTLED_{i,m,h}(t), FMSR_{i,m,h}(t)))}{3600} dt + \\ &\int_{T_{h,k-1}}^{T_{h,k}} \frac{\min(0, \max(G_{MINi}, DOP_i(t), RTLED_{i,m,h}(t), FMS_{i,h}(t)) - FMSR_{i,m,h}(t))}{3600} dt \end{aligned} \right\} \begin{array}{l} \therefore m \in RTD \\ \therefore i \in S_{MSS} - S_{NGR} \end{array}
 \end{aligned}$$

$$\begin{aligned}
LOOE_{i,m,h,f} &= \left. \begin{aligned} &\int_{T_{h,f-1}}^{T_{h,f}} \frac{\min(0, \max(FMS_{i,h}(t), DAS_{i,h}, SR_{i,h}(t)) - \min(LRTLOL_{i,m,h}(t), ED_{BNDi,m,h}(t), RTLED_{i,m,h}(t), DASR_{i,h}(t)))}{3600} dt + \\ &\int_{T_{h,f-1}}^{T_{h,f}} \frac{\min(0, \max(FMS_{i,h}(t), RTLED_{i,m,h}(t), DAS_{i,h}, SR_{i,h}(t)) - \min(L_{MINi}, DASR_{i,h}(t)))}{3600} dt + \\ &\int_{T_{h,f-1}}^{T_{h,f}} \frac{\max(0, \min(L_{MINi}, FMS_{i,h}(t), DAS_{i,h}, SR_{i,h}(t)) - \max(LRTUOL_{i,m,h}(t), ED_{BNDi,m,h}(t), RTUED_{i,m,h}(t), DASR_{i,h}(t)))}{3600} dt + \\ &\int_{T_{h,f-1}}^{T_{h,f}} \frac{\max(0, \min(L_{MINi}, FMS_{i,h}(t), RTUED_{i,m,h}(t), DAS_{i,h}, SR_{i,h}(t)) - DASR_{i,m,h}(t))}{3600} dt \end{aligned} \right\} \begin{aligned} &\therefore m \in FMM \\ &\therefore i \in S_{MSS} - S_{NGR} \end{aligned} \\
LOOE_{i,m,h,k} &= \left. \begin{aligned} &\int_{T_{h,k-1}}^{T_{h,k}} \frac{\min(0, \max(DOP_i(t), FMS_{i,h}(t)) - \min(LRTLOL_{i,m,h}(t), ED_{BNDi,m,h}(t), RTLED_{i,m,h}(t), FMSR_{i,h}(t)))}{3600} dt + \\ &\int_{T_{h,k-1}}^{T_{h,k}} \frac{\min(0, \max(DOP_i(t), RTLED_{i,m,h}(t), FMS_{i,h}(t)) - \min(L_{MINi}, FMSR_{i,h}(t)))}{3600} dt + \\ &\int_{T_{h,k-1}}^{T_{h,k}} \frac{\max(0, \min(L_{MINi}, DOP_i(t), FMS_{i,h}(t)) - \max(LRTUOL_{i,m,h}(t), ED_{BNDi,m,h}(t), RTUED_{i,m,h}(t), FMSR_{i,h}(t)))}{3600} dt + \\ &\int_{T_{h,k-1}}^{T_{h,k}} \frac{\max(0, \min(L_{MINi}, DOP_i(t), RTUED_{i,m,h}(t), FMS_{i,h}(t)) - FMSR_{i,m,h}(t))}{3600} dt \end{aligned} \right\} \begin{aligned} &\therefore m \in RTD \\ &\therefore i \in S_{MSS} - S_{NGR} \end{aligned}
\end{aligned}$$

For all resources except NGRs, the Optimal Energy is the sum of Overlapping and Non-overlapping Optimal Energy as follows:

$$\left. \begin{aligned} &OE_{i,m,h,f} = OOE_{i,m,h,f} + NOE_{i,m,h,f} \quad \therefore m \in FMM \\ &OE_{i,m,h,k} = OOE_{i,m,h,k} + NOE_{i,m,h,k} \quad \therefore m \in RTD \end{aligned} \right\} \therefore i \notin S_{NGR} \cup S_{HPD} \cup S_{TIE} \cup S_{ECA} \quad \blacksquare$$

For NGRs, the Optimal Energy is the sum of Overlapping and Non-overlapping Optimal Energy as follows:

$$\left\{ \begin{array}{l} OE_{i,m,h,f} = GOOE_{i,m,h,f} + LOOE_{i,m,h,f} + GNOE_{i,m,h,f} + LNOE_{i,m,h,f} \quad \therefore m \in FMM \\ OE_{i,m,h,k} = GOOE_{i,m,h,k} + LOOE_{i,m,h,k} + GNOE_{i,m,h,k} + LNOE_{i,m,h,k} \quad \therefore m \in RTD \end{array} \right\} \therefore i \in S_{NGR}$$

### C.2.1.23 RMR Energy

The calculation of RMR energy is not dependent and/or related to any other Expected Energy calculation. It is calculated to fulfill the RMR contractual settlement requirement. It is calculated as the total energy under the RMR MW, which is calculated as it follows,

Based on the MPM process, the RMR MW level will be determined per RMR resource (including condition 1 and condition 2) for a given time in the following three steps,

Step 1,

If RT RMR Requirement  $\diamond 0$  Then

$$RMR\_MW = DOP$$

Else If DA RMR Requirement  $\diamond 0$  Then

$$RMR\_MW = \min(\max(IFM\_commitment, RUC\_commitment, STUC\_commitment), DOP)$$

End If

Step 2,

If there exists RMR Exceptional Dispatch Instruction other than RMRS Then

$$RMR\_MW = \max(RMR\_Exceptional\_Dispatch, RMR\_MW)$$

Else if RMR Exceptional Dispatch Instruction is “RMRS” Then

If RMR instruction is a “MAX” instruction Then

- Indicating that this resource is the original RMR resource being substituted
- RMR\_MW should be increased for RMR energy calculation

$$RMR\_MW = RMR\_MW + (IFM\_Commitment - RMR\_Exceptional\_Dispatch)$$

Else -- This is the substituting resources

-- RMR\_MW should be decreased for RMR energy calculation

$$RMR\_MW = RMR\_MW - (RMR\_Exceptional\_Dispatch - IFM\_Commitment)$$

End If

End If

Step 3,

$$RMR\_MW = \min(MNDC, RMR\_MW)$$

Where:

*RMR\_MW* is the RMR MW level used in RMR energy calculation (time variant because it is tied to the DOP);

*RT RMR Requirement* The RMR requirement MW determined by Real-Time MPM process. (15-minute);

- DA RMR Requirement* The RMR requirement MW determined by Day-Ahead MPM process. (hourly);
- IFM\_Commitment* BINDING commitment schedule MW from IFM. Assume zero if none exists (hourly);
- RUC\_Commitment* BINDING commitment schedule MW from RUC. Assume zero if none exists (hourly);
- STUC\_Commitment* BINDING commitment schedule MW from RTM through the short term unit commitment process. Assume zero if non exists (15 minute);
- DOP* Dispatch Operating Point from RTM;
- RMR Exceptional Dispatch* The Exceptional Dispatch MW when the Exceptional Dispatch Energy code is one of the four types: “RMRR”, “RMRS”, “RMRT”, “RMRV” – This can be simplified as essentially all Exceptional Dispatch Energy code beginning with the letters “RMR”;
- Previous DOT* Dispatch Operating Target (MW) for the previous 5-minute interval from RTM (5-minute);
- MNDC* RMR Contractual Capacity defined in MF for RMR resources. It can be less or equal to the Pmax;

#### C.2.1.24 EE treatment for EIM resources

1. Calculate BASE energy for all EIM resources:  $BASE_{i,h} = BSEIM_{i,h} \times 1hr \therefore i \in S_{EIM}$
2. For participating EIM resources, calculate real-time EE as indicated in the above sections C.2.1.1.7 through C.2.1.1.23, except replace the following terms:
  - a. Replace *DAS* with *BSEIM*, i.e. all RT energy is relative to the BASE schedule. EIM resources do not directly participate in the DA market, thus do not have a *DAS*.

- b. Replace *ED* with *MD*.

For non-participating EIM resources, calculation of real-time EE is the same as for participating EIM resources. Since the non-participating EIM resource does not submit energy bids, the EE calculation will be performed using the Default Energy Bid of the resource.

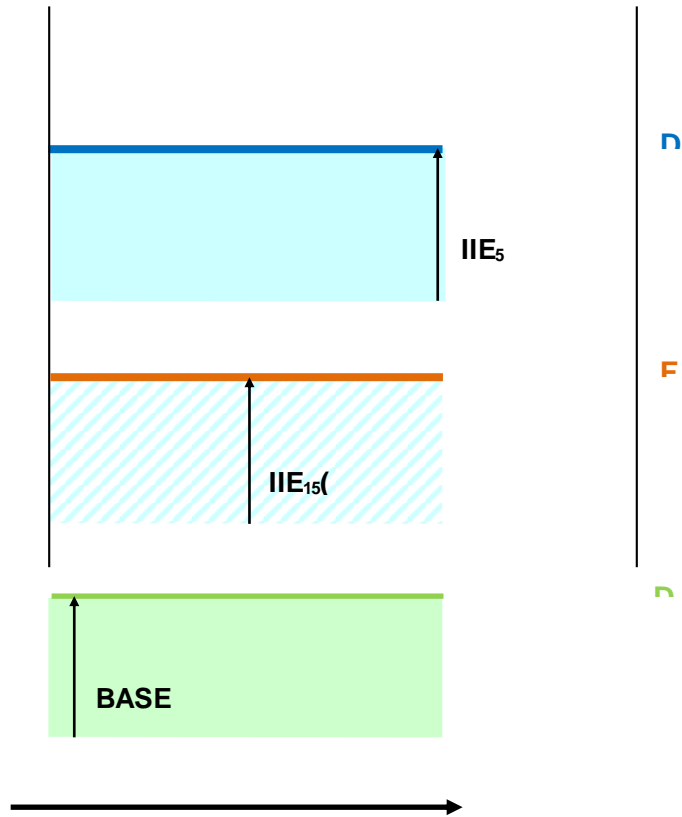



**Figure 5t Expected energy for an EIM Participating Resource.**  $i \in S_{EIMPR}$ 

3. Special rule when a BASE schedule is submitted below  $P_{MIN}$  and above zero for purposes of submitting startup energy. To support settlement of startup energy, Total Expected Energy (TEE) is set equal to BASE energy, assuming startup energy is equivalent to the BASE schedule.
  - a. Calculate BASE energy per item 1 above.
  - b. Set TEE = BASE energy.

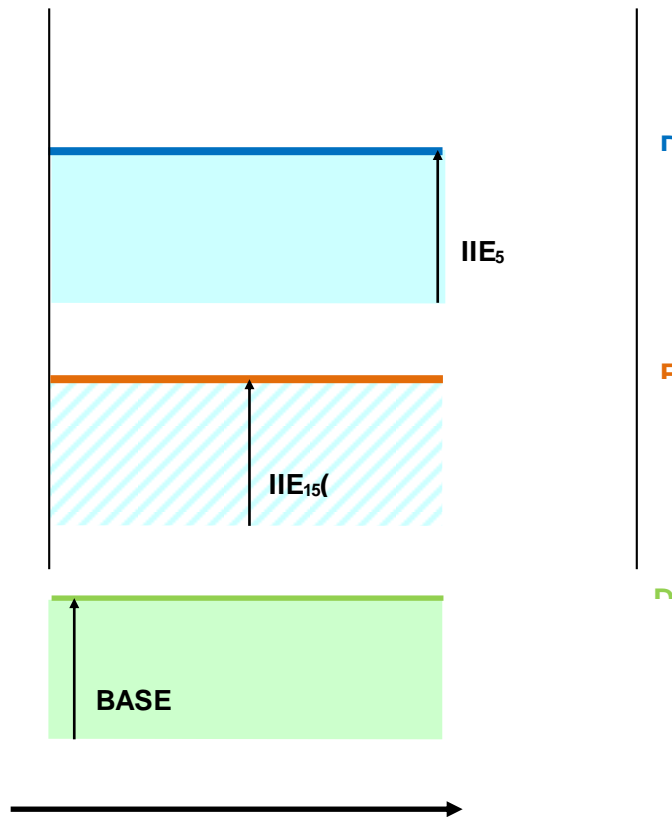

Figure 5t Expected energy for an EIM Participating Resource.  $i \in S_{EIMPR}$

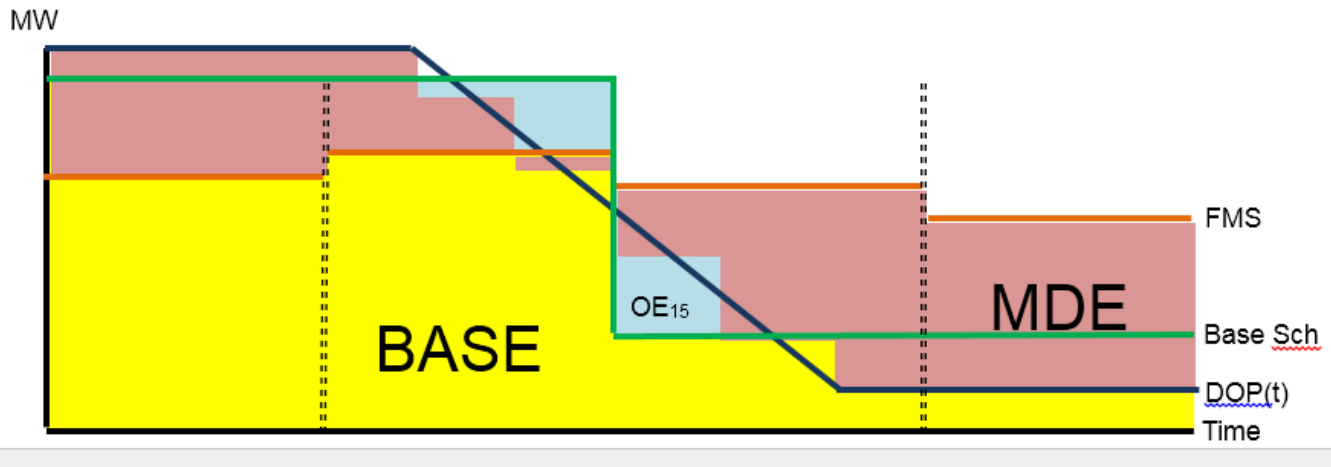

Figure 5u Expected energy for an EIM non-participating resource with MDE.  $i \in S_{EIMNPR}$

C.2.1.25 Total Expected Energy

$$TEE_{i,h,k} = \int_{T_{h,k-1}}^{T_{h,k}} \frac{DOP_i(t)}{3600} dt$$

C.2.1.26 Ramping Dispatch Operating Target

$$RDOT_i(t) \equiv DOT_{l-1} + \frac{DOT_l - DOT_{l-1}}{T_l - T_{l-1}} (t - T_{l-1}) \quad \therefore T_{l-1} \leq t \leq T_l$$

### C.2.1.27 Total Target Expected Energy

$$TTEE_{i,h,k} = \int_{T_{h,k-1}}^{T_{h,k}} \frac{RDOT_i(t)}{3600} dt$$

### C.2.1.28 Ramping Tolerance

$$RAMPT_{i,h,k} = TTEE_{i,h,k} - TEE_{i,h,k}$$













### C.2.1.29 Exceptional Dispatch Energy and Its Pricing

In expected energy allocation, the bid prices used for Exceptional Dispatch Energy will be based on CAISO tariff section 11.5.6 depending on the individual Exceptional Dispatch Instruction type. Furthermore, after the appropriate Energy Bid prices are allocated, the Exceptional Dispatch Energy determined by the extended Exceptional Dispatch Instruction as described in C2.1.1.15 will be re-classified as Optimal Energy with its Bid prices determined by Exceptional Dispatch rules.

### C.2.1.30 Energy Type Legend

CAISO uses the following legend to identify the different types of Energy:

# Legend

 DA Schedule	 Load Following Instruction <sup>†</sup>
 Dispatch Operating Point	 Exceptional Dispatch Instruction
 Locational Marginal Price	 Reference Schedule
 IFM Energy	 Load Following Energy
 Standard Ramping Energy	
 Ramping Energy Deviation	
 Optimal Energy	
 Residual Imbalance Energy	
 Exceptional Dispatch	

### C.2.1.31 General Imbalance Energy Calculation Rules

Following rules apply to all Dynamic System Resources that are not MSS Load Following and not System Resources. Following are the main rules,

- θ Energy types with the same sign stack up; they do not overlap
- θ Energy types with opposite signs overlap
- θ Standard Ramping Energy is always present and it may overlap with DA Schedule Energy
- θ Ramping Energy Deviation may only overlap with Standard Ramping Energy and/or DA Schedule Energy
- θ Residual Energy may only overlap with DA Schedule Energy

Optimal and Exceptional Dispatch Energy do not overlap with each other, but they may overlap with DA Schedule Energy.

Note: for illustration purposes, only energy from Day-Ahead and Real-Time Dispatch schedules are shown. Assume Fifteen-Minute Market Schedules equal Real-Time Dispatch.

Exhibit C-1 illustrates the DA Energy breakdown. It assumes that there is a DA Self-Schedule and Energy Bid for the corresponding resource. It also assumes that the resource has a non-zero Pmin.

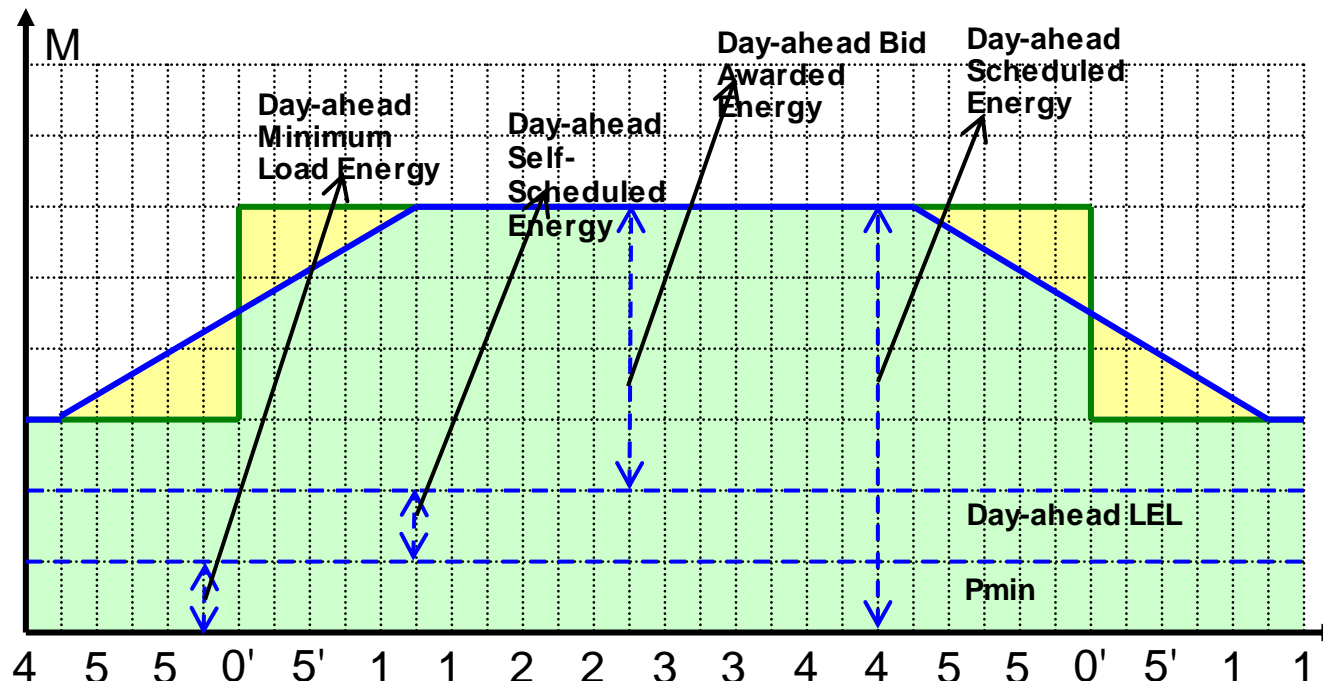
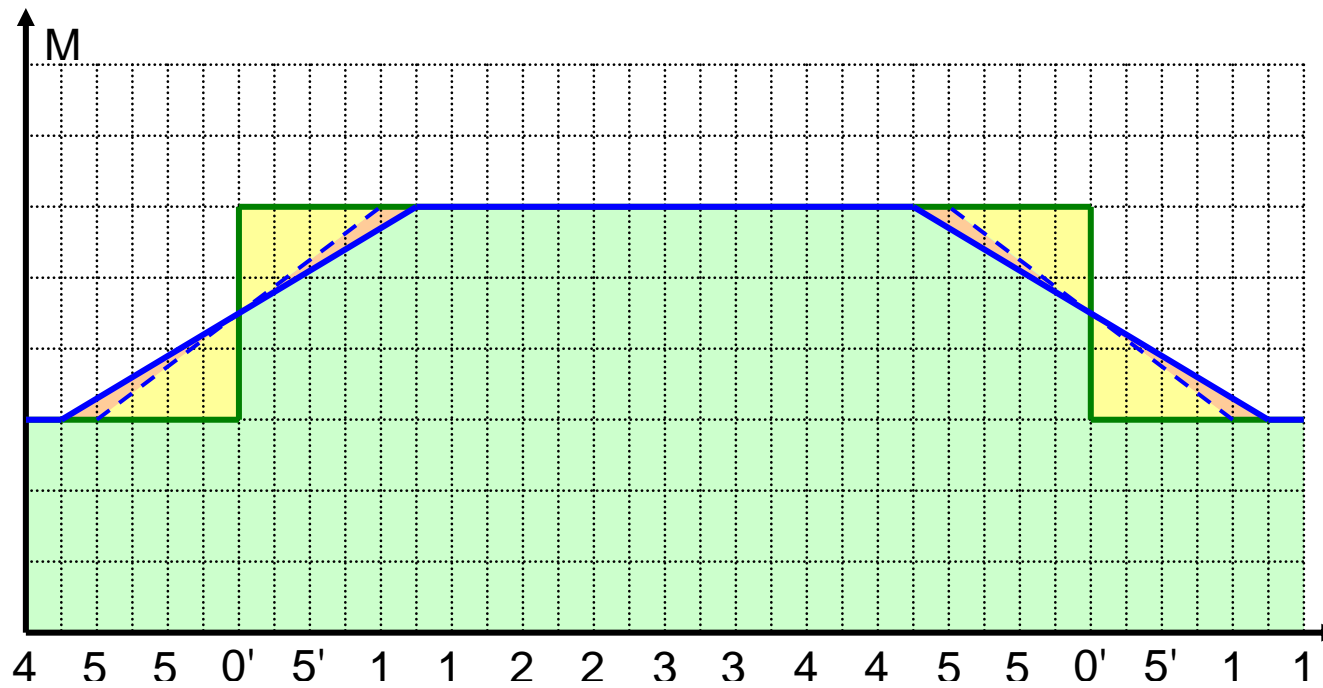
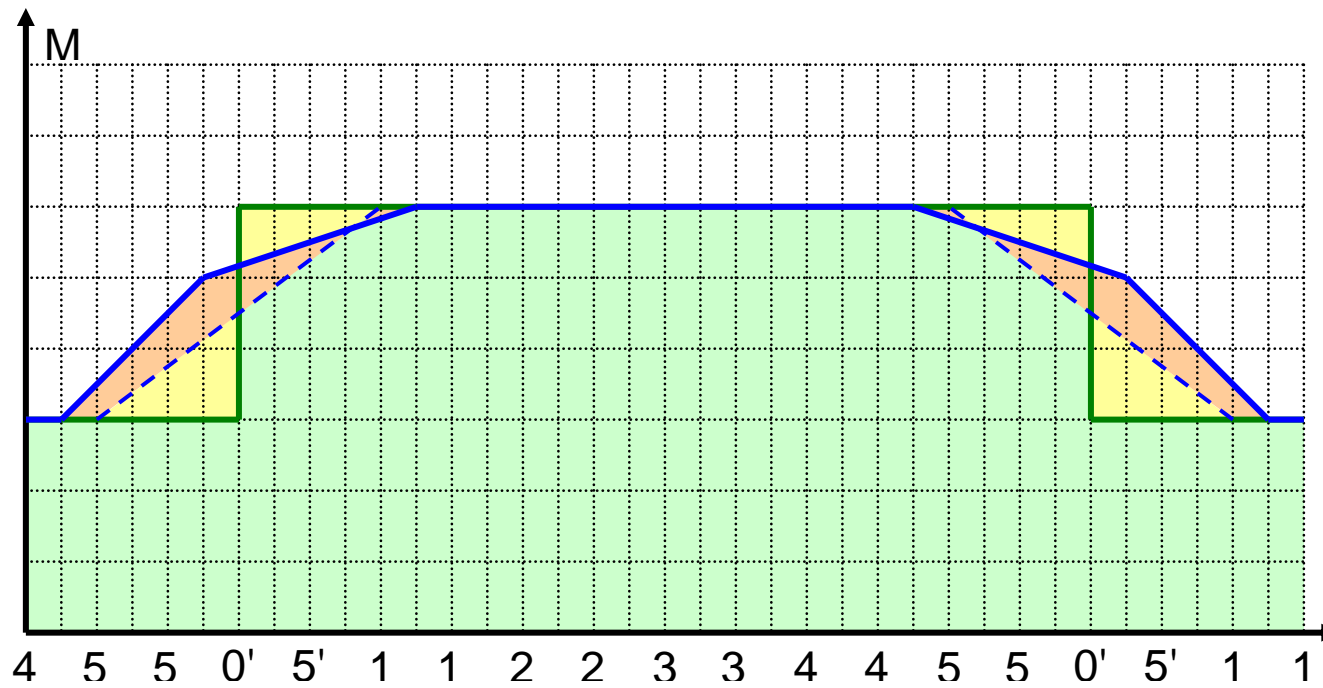

Exhibit C-1: Day-ahead Energy Breakdown

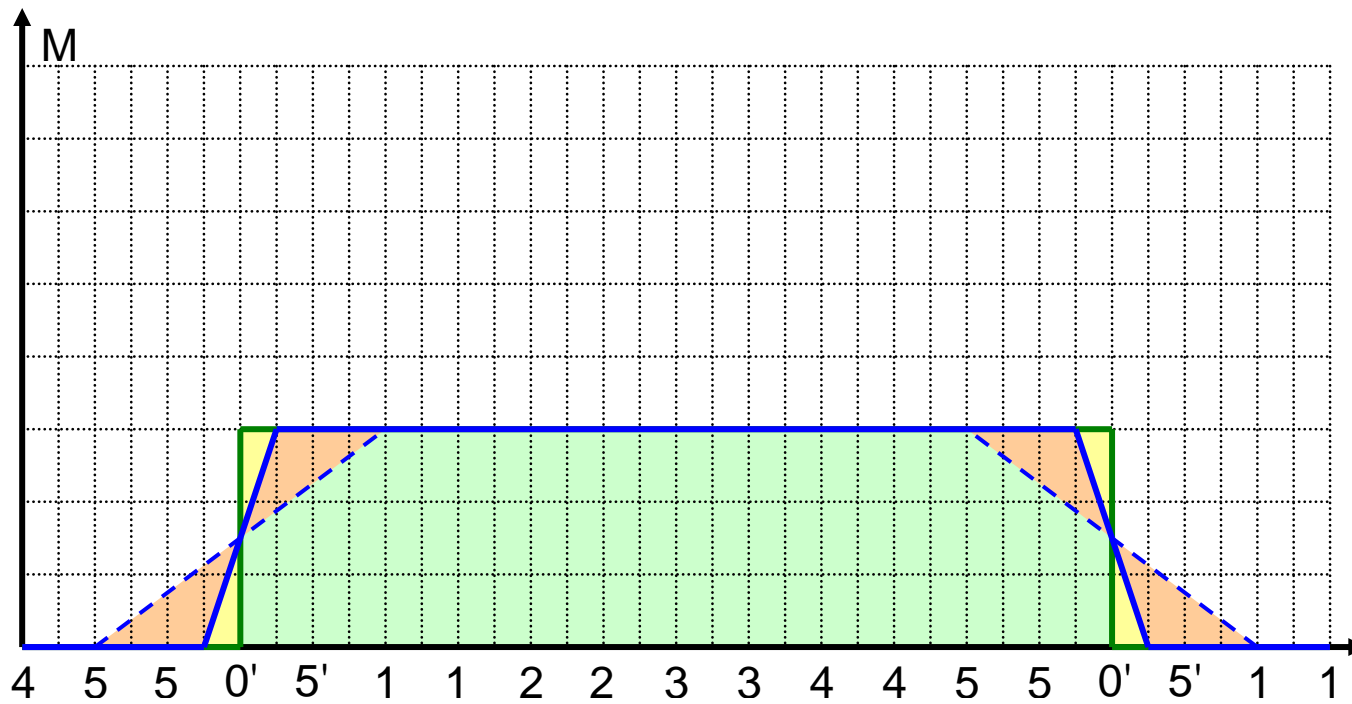

**Exhibit C-2: Standard Ramping Energy and Ramping Energy Deviation (with ramping deviation caused by slower ramp)**





**Exhibit C-3: Ramping Energy Deviation (Changing Ramp Rate)**



**Exhibit C-4: Ramping Deviation (Startup & Shutdown)**

Exhibit C-5 shows an economic Dispatch that generates a DOP curve ramping first up towards the current hour, ramp down below the DA Schedule in the middle of hour, then ramp further down below the Day-Ahead Schedule in the following hour.

This dispatch pattern results in the following Expected Energy: Day-Ahead Schedule Energy, Standard Ramping Energy, Ramping Energy Deviation, Optimal Energy, Residual Imbalance Energy.

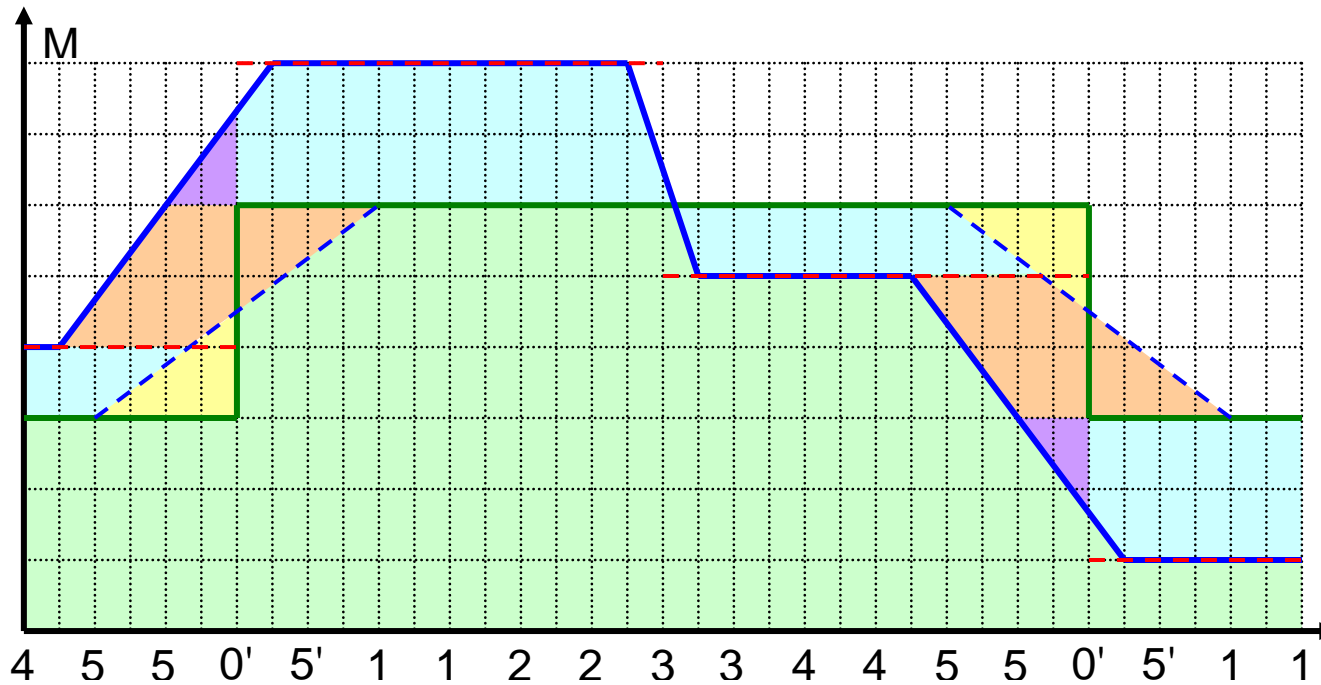

**Exhibit C-5: Comprehensive Economic Dispatch Case 1**

Exhibit C-6 shows an economic dispatch that generates a DOP curve ramping first up towards the current hour however below Day-Ahead Schedule, further ramp up above the Day-Ahead Schedule in the middle of hour, then ramp further down but above

the Day-Ahead Schedule in the following hour. This dispatch pattern results in the following Expected Energy: Day-Ahead Schedule Energy, Standard Ramping Energy, Ramping Energy Deviation, Optimal Energy, Residual Imbalance Energy.

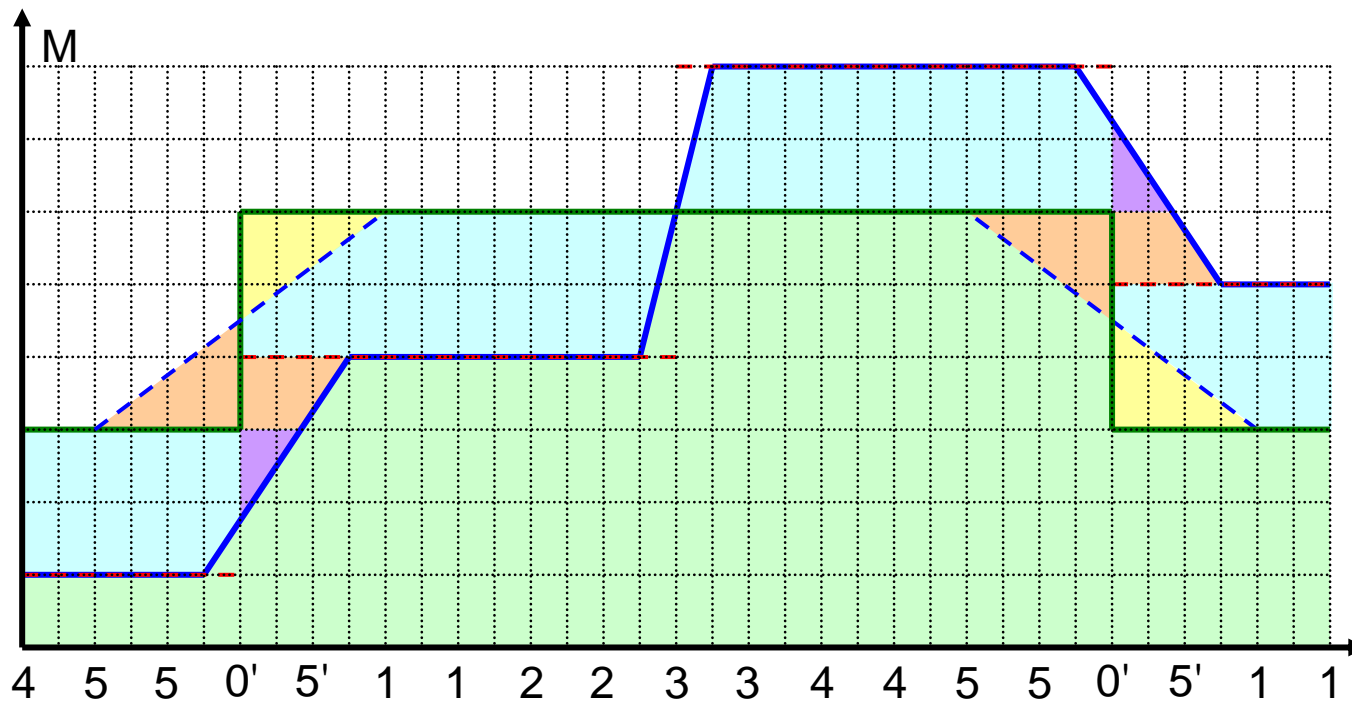
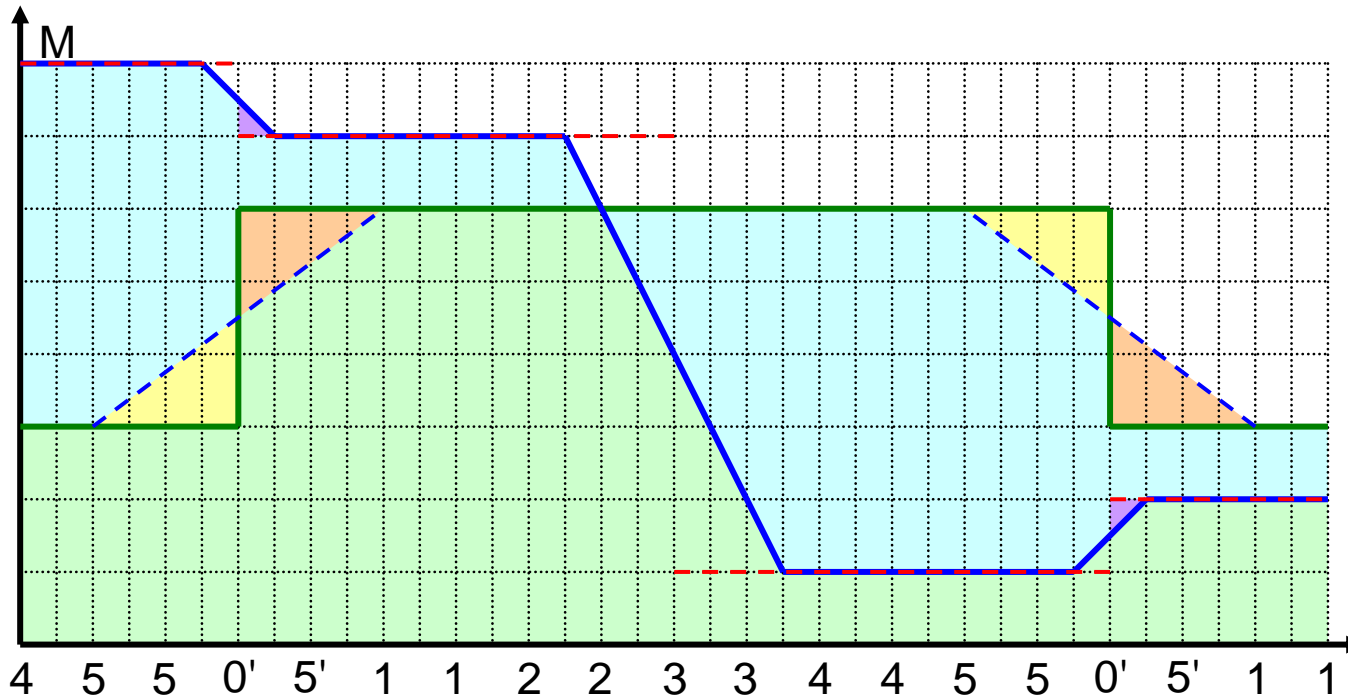

Exhibit C-6: Comprehensive Economic Dispatch Case 2

Exhibit C-7 shows an economic Dispatch that generates a DOP curve ramping first down towards the current hour however above Day-Ahead Schedule, further ramp down below the Day-Ahead Schedule in the middle of hour, then ramp further up but

below the Day-Ahead Schedule in the following hour. This dispatch pattern results in the following Expected Energy: Day-Ahead Schedule Energy, Standard Ramping Energy, Ramping Energy Deviation, Optimal Energy, Residual Imbalance Energy.

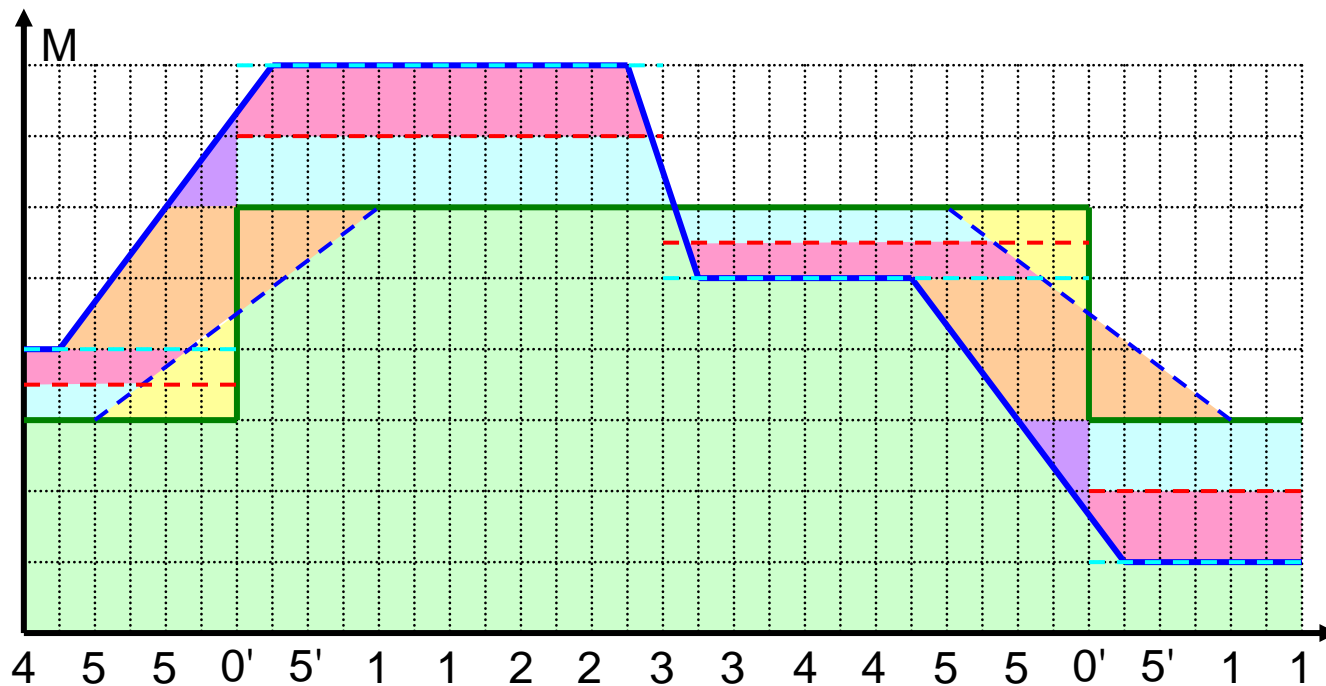

**Exhibit C-7: Comprehensive Economic Dispatch Case 3**

Exhibit C-8 shows the impact of Exceptional Dispatch. The DOP curve ramps first up towards the current hour, ramp down below the Day-Ahead Schedule in the middle of hour, then ramp further down below the Day-Ahead Schedule in the following

hour. This dispatch pattern results in the following Expected Energy: Day-Ahead Schedule energy, standard ramping energy, ramping energy deviation, Optimal Energy, Residual Imbalance Energy and Exceptional Dispatch Energy.

Exceptional Dispatch energy is either Incremental energy above the RT LMP MW and below the lower of the DOP or the Exceptional Dispatch instruction; or Decremental energy below the RT LMP MW and above the higher of the DOP or the Exceptional Dispatch instruction.



**Exhibit C-8: Comprehensive Exceptional Dispatch Case 1**

Exhibit C-9 shows an Exceptional Dispatch that generates a DOP curve ramping first up towards the current hour however below Day-Ahead Schedule, further ramp up above the Day-Ahead Schedule in the middle of hour, then ramp further down but above the Day-Ahead Schedule in the following hour. This dispatch pattern results in the following Expected Energy: Day-Ahead Schedule Energy, Standard Ramping Energy, Ramping Energy Deviation, Optimal Energy, Residual Imbalance Energy and Exceptional Dispatch Energy.

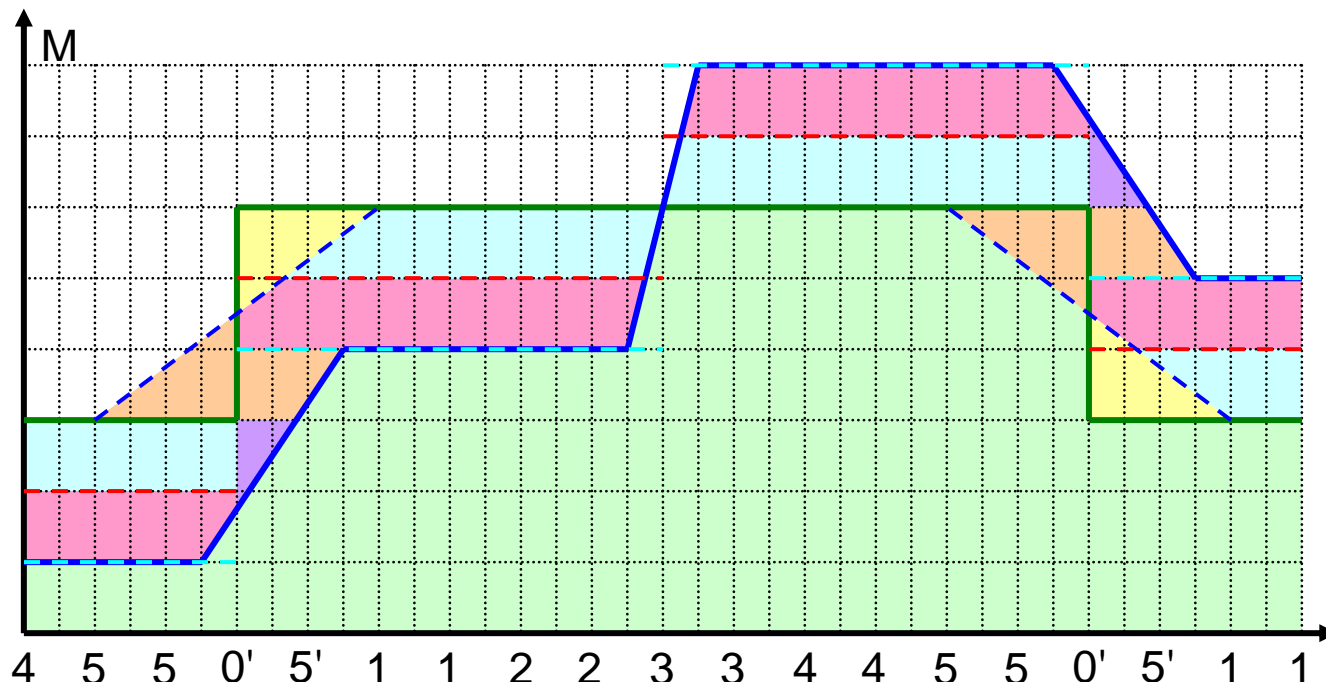

Exhibit C-9: Comprehensive Exceptional Dispatch Case 2

Exhibit C-10 takes the original example from D-9 and shows the impact of a OMS de-rate/rerate. In D-10, it assumes a OMS de-rate of  $P_{max}$  between min 0' to 27.5' in current hour and a OMS rerate of  $P_{min}$  between 0' and 15' in the next hour. This causes negative de-rate energy and positive de-rate energy in the corresponding time period.

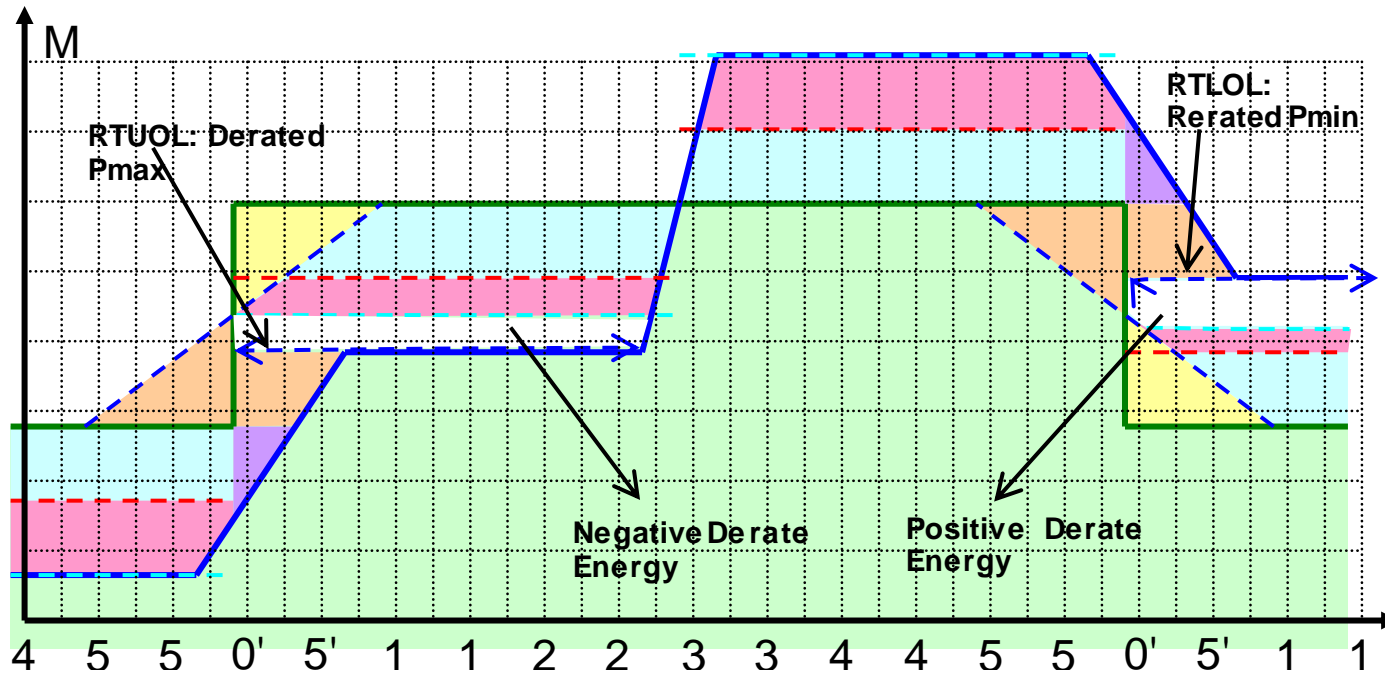

Exhibit C-10: Impact of OMS de-rate/rerate (De-rate Energy)



---

### **C.2.1.32 Expected Energy in Pumping Mode**

Following rules apply to all Pumped-Storage Hydro Resource in pumping mode and Pump resources (Participating Load). For such resources, the possible Expected Energy generated under zero can be DA Pumping Energy, RT Pumping Energy, Standard Ramping Energy and Ramping Energy Deviation

- θ DA Pumping Energy is always negative and there is no further breakdown of DA Pumping Energy
- θ RT Pumping Energy can be positive or negative
- θ Standard Ramping Energy and Ramping Energy Deviation follow the same rules described in D.3.1.3
- θ DA and RT Pumping Energy can overlap each other
- θ Even though there can be HASP Intertie Schedule or Exceptional Dispatch equal or below zero, corresponding Imbalance Energy is always accounted for as RT Pumping Energy

Note: for illustration purposes, only energy from Day-Ahead and Real-Time Dispatch schedules are shown. Assume Fifteen-Minute Market Schedules equal Real-Time Dispatch.

Exhibit C-11 shows a case that a Pump resource has been committed in DA pumping mode and get dispatched in Real-Time in Pumping mode for the current hour. It also assumes the resource is off-line for the previous and next hour. In this case, the Expected Energy generated include DA pumping energy, Standard Ramping Energy and Ramping Energy Deviation.

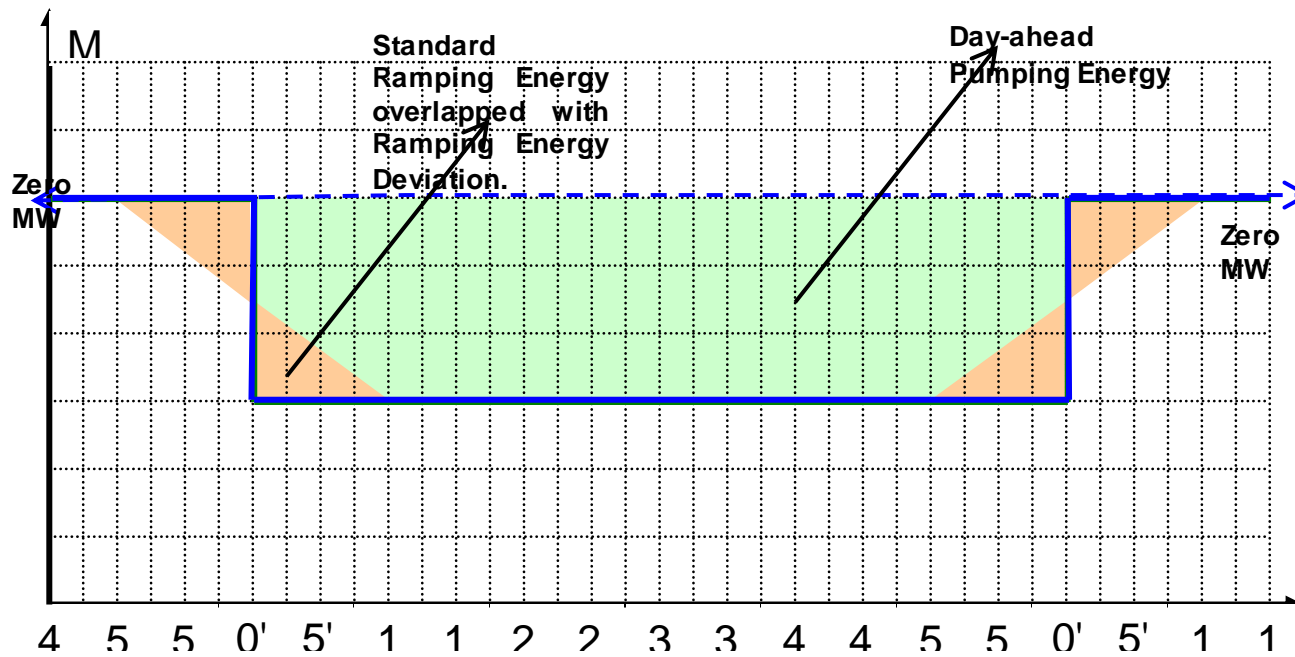

**Exhibit C-11: Day-ahead Pumping Energy**

Exhibit C-12 shows a case that a Pump resource has been committed in DA pumping mode and then committed off-line in Real-Time. A DOP being zero had been dispatched. It also assumes the resource is off-line for the previous and next hour. In this case, the Expected Energy generated include DA pumping energy (negative), Real-time pumping energy (positive), Standard Ramping Energy and Ramping Energy Deviation

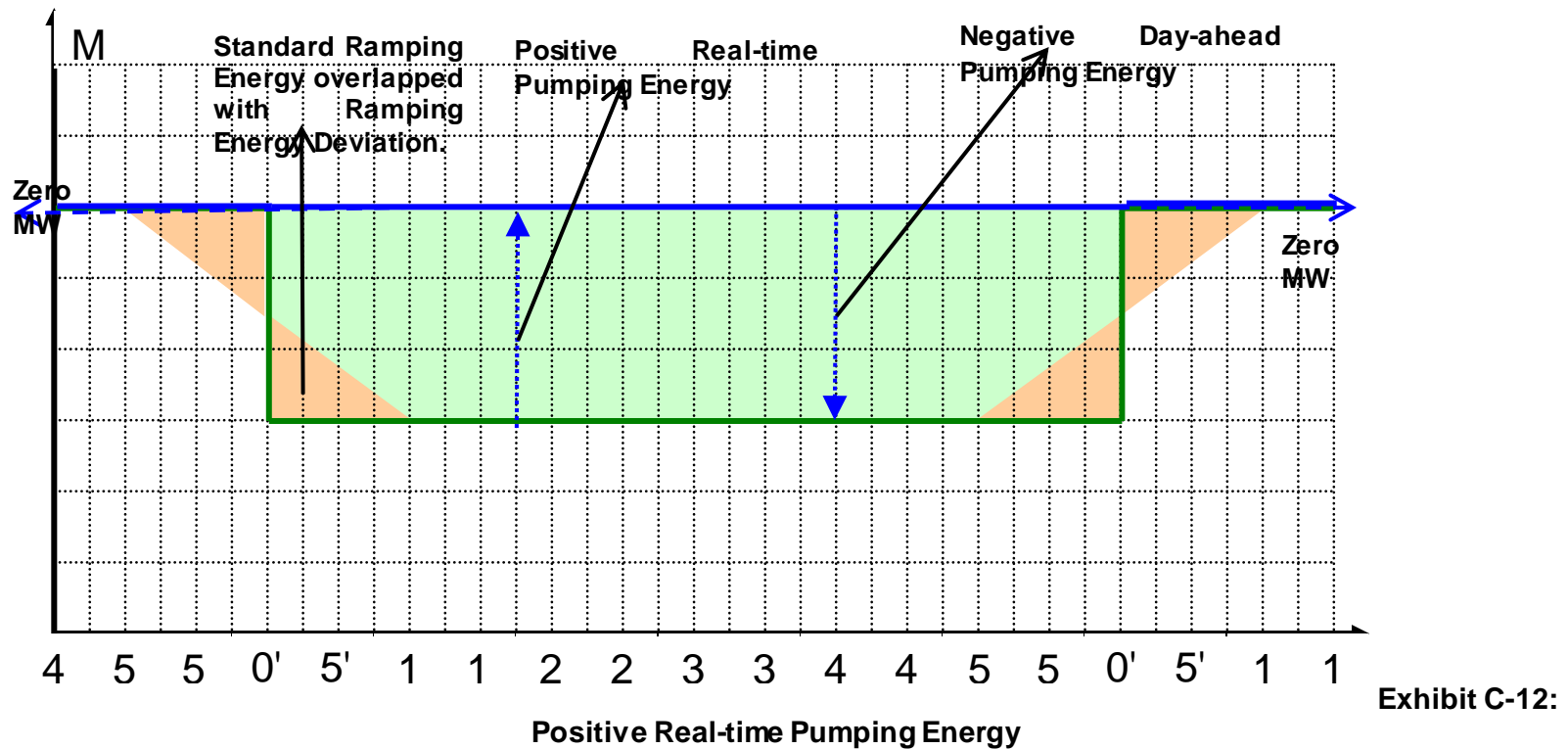
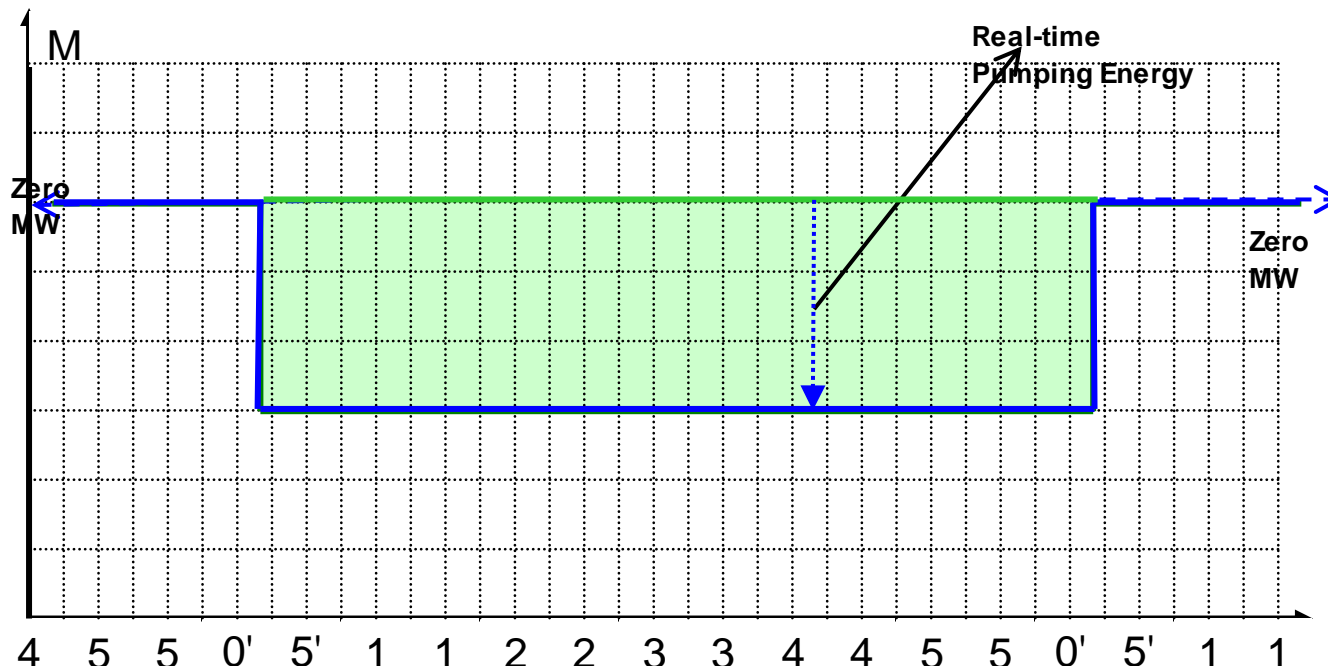
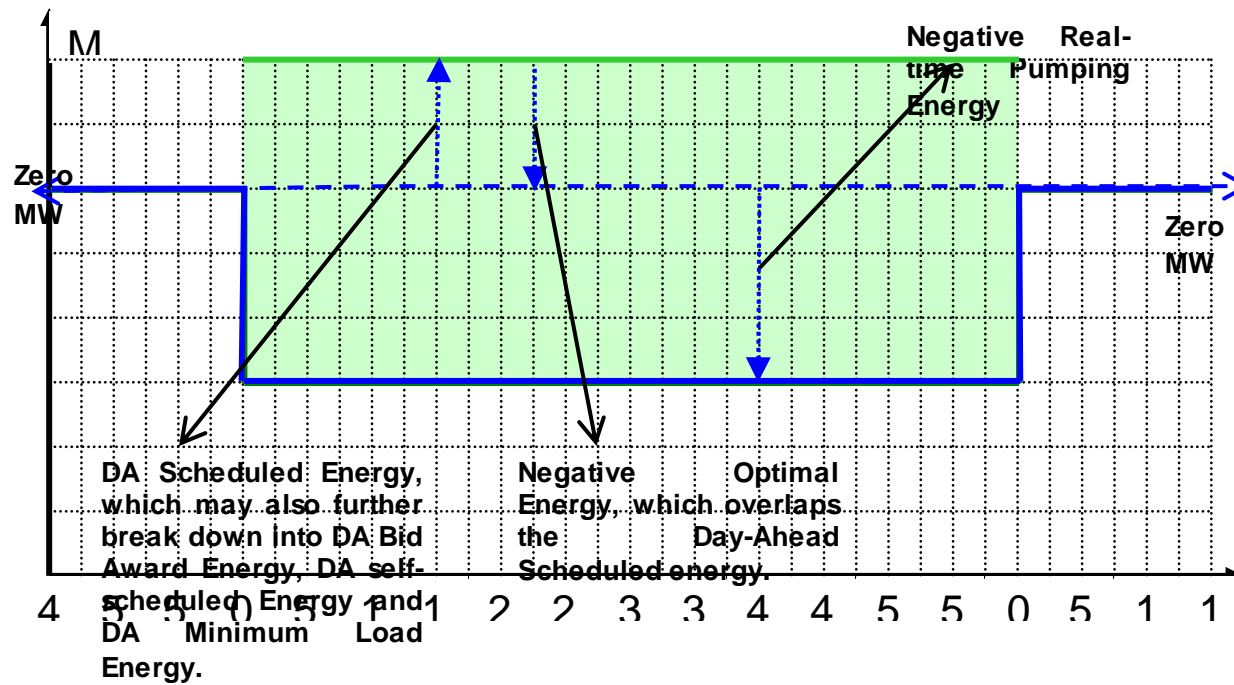

Exhibit C-13 shows a case that a Pump resource has not been committed in DA (offline mode) and then committed on-line in Real-Time. A DOP below zero had been dispatched and a vertical curve is used for startup and shutdown. It also assumes the resource is off-line for the previous and next hour. In this case, the Expected Energy generated includes Real-time pumping energy (negative).



**Exhibit C-13: Negative Real-time Pumping Energy**

Exhibit C-14 shows a case that a Pumped-Storage Hydro (PSH) Resource has been committed in DA generation mode and then committed in pumping mode in Real-Time. A DOP below zero had been dispatched and a vertical curve is used for startup and shutdown. It also assumes that the resource is off-line for the previous and next hour. In this case, the Expected Energy generated includes Day-Ahead Scheduled energy, Negative Optimal Energy and Negative Real-time Pumping Energy. The energy above zero MW uses the same rules described in D 3.1.3.



**Exhibit C-14: PSH from DA generation mode to Real-time pumping mode**

Exhibit C-15 shows a case that a Pumped-Storage Hydro (PSH) Resource has been committed in DA pumping mode and then committed in generation mode in Real-Time. In this case, the Expected Energy generated includes negative DA Pumping Energy, positive Optimal Energy and positive Real-Time Pumping Energy and Real-Time Minimum Load Energy. The energy above zero MW uses the same rules described in D 3.1.3.

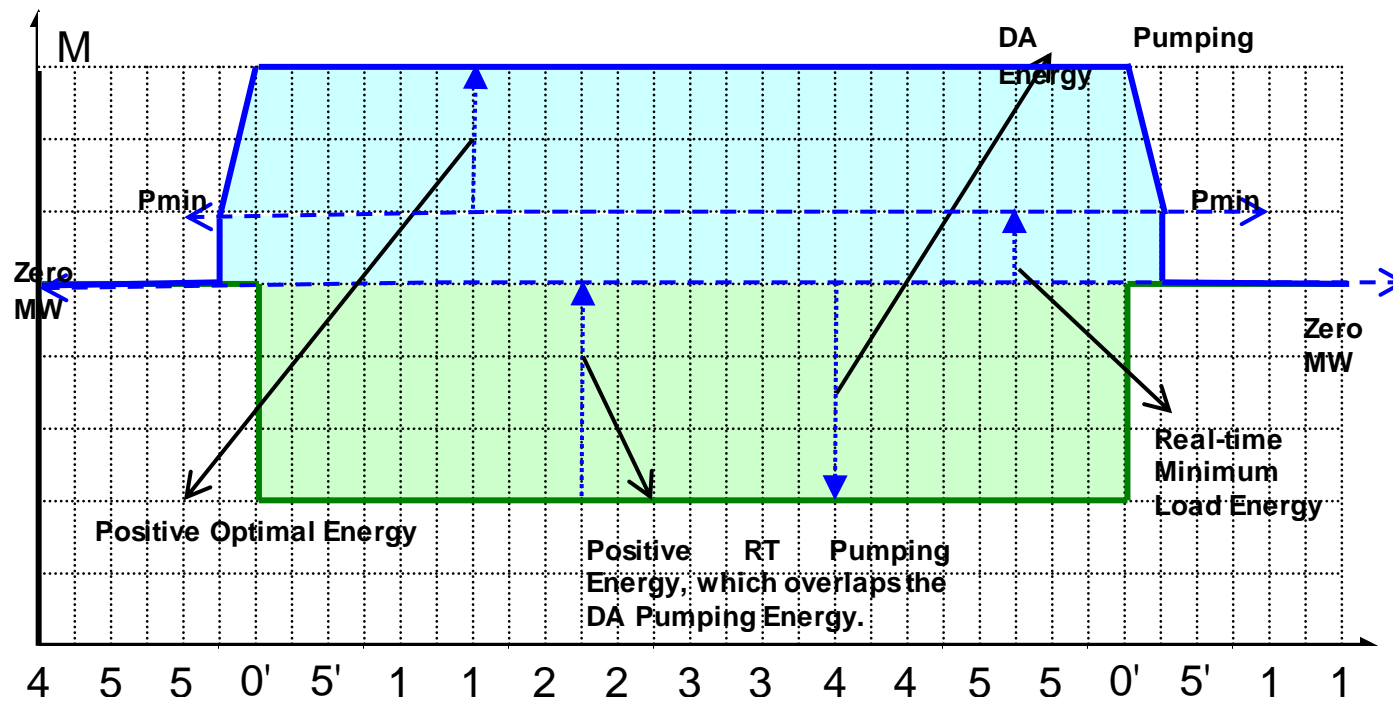

**Exhibit C-15: PSH from DA pumping mode to RT generation mode**

**C.2.1.33 Block Accounting in Expected Energy**

When calculating Expected Energy for System Resources (hourly pre-dispatched or not) and Non-Dynamic Resource-Specific System Resources, the block accounting method is deployed. The block accounting method uses a step function at the relevant DOT as the converted “block DOP” when calculating the Expected Energy under the curve. It is important to note that, after the application of the “block DOP”, all other Expected Energy calculation rules are the same as other resources. Exhibit 16 takes D-6 as the original example and apply the block accounting method to the DOP, it resolves in the converted DOP curve (indicated by the pink dotted line). Notice that, while all Expected Energy calculation principle stays the same, the

Expected Energy for each interval is different now under the “block DOP” from the Expected Energy under the original DOP (dispatched from ADS).

Note: for illustration purposes, only energy from Day-Ahead and Real-Time Dispatch schedules are shown. Assume Fifteen-Minute Market Schedules equal Real-Time Dispatch.

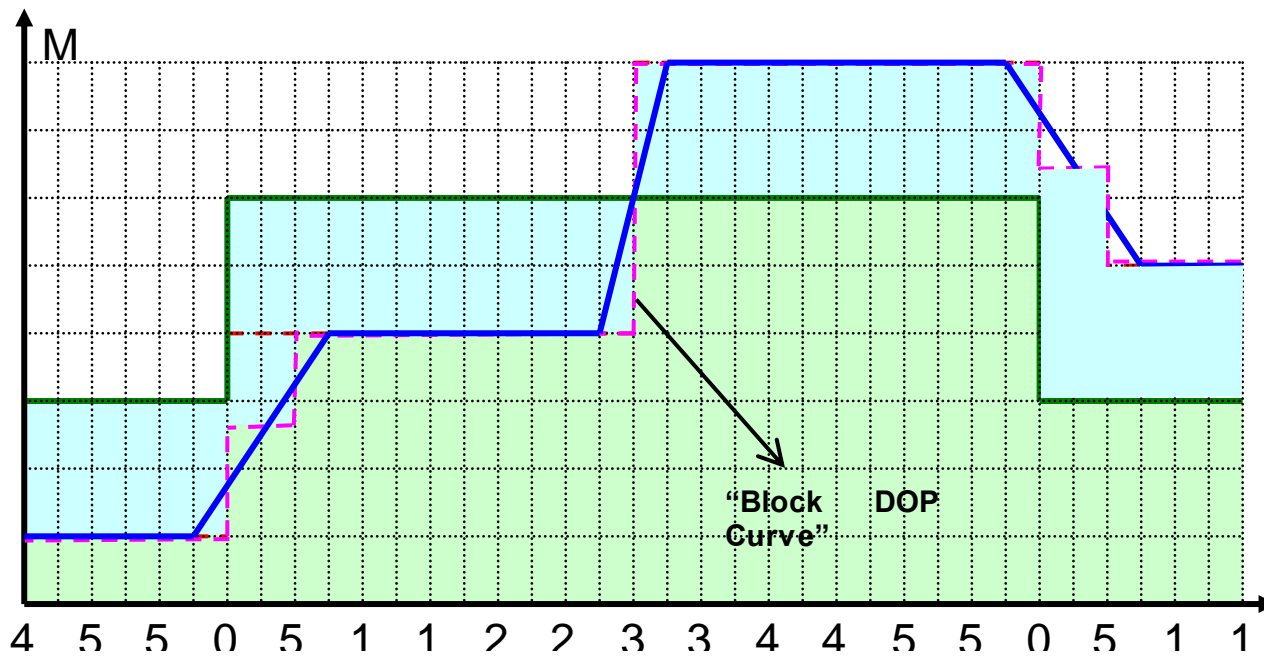

Exhibit C-16: Expected Energy under the block accounting method (Non HPD Tie)

### **C.2.1.34 MSS Load Following Energy**

MSS Load Following Energy (MSSLFE) is the area between the Load Following Instruction and the Day-Ahead Schedule. Optimal and Exceptional Dispatch Energy do not overlap with each other, but they may overlap with Day-Ahead Scheduled Energy and/or MSS Load Following Energy. An important point to indicate is that, all MSS load following instructions mentioned here are the qualified MSS load following instructions. The data flow for these instructions is as it follows,

Step 1: MSS MPs send in the MSS load following instructions through ADS API on a 5-minute or hourly base;

Step 2: ADS will publish these instructions to RTN through interval web services;

Step 3: RTN will evaluate these instructions and apply appropriate adjustments if necessary. This results in the qualified MSS load following instructions. RTN further uses these qualified instructions in its dispatch for the MSS load following resources. Dispatch Instructions are sent to MSS MPs through ADS which includes the qualified instructions as part of the DOT breakdown;

Step 4: MQS will use the qualified MSS load following instructions in clarification of Expected Energy for MSS load following resources.



---

C-18 takes the comprehensive economic Dispatch case in C-5 and adds in the MSS Load Following Instructions. Because of the MSS Load Following Instructions, the clarifications of Expected Energy do change now.

C-18 illustrates the following cases:

1. Between interval 45' and 52.5' in the previous hour, there is positive MSS Load Following energy incurred due to the MSS load following up instructions. Since the economic dispatches “agree” with the load following up, there is further positive Optimal Energy incurred, but however there is no overlapping between Optimal Energy and MSS Load Following Energy. Between interval 50' to 52.5', it is also important to note that, standard ramping takes precedence over MSS Load Following Energy. They do not overlap each other;

2. Between interval 0' and 30' in the current hour, similar to item 1, the MSS load following up instructions “agree” with the economic Dispatches, hence both positive Optimal Energy and MSS Load Following Energy are incurred and they do not overlap. Between interval 27.5' to 30', there is a small triangle above the DOP that shows the overlapping between positive MSS Load Following Energy and negative Optimal Energy. This is caused by the ramping down case in which the dispatches “disagree” with the MSS load following up instructions;

3. Between interval 30' and 50' in the current hour, there are three Expected Energy related to the topic of MSS load following:

3.1. Triangle area (between 30' and 32.5') below DOP and above Day-Ahead Schedule is clarified as positive Optimal Energy. The reason is because it is incremental Energy above Day-Ahead Schedule and we deem that having no relationship to the MSS load following down instruction;

3.2. Area (between 32.5' and 0') below the DOP and standard ramp curve AND above the DOP and MSS load following down instruction is clarified as MSS Load Following Energy. It is not overlapping with any other Expected Energy. The reason is that,

that decremental Energy is deemed to be solely caused by the MSS load following down instructions. Furthermore, the standard ramping area is not affected since standard ramping takes precedence over MSS Load Following Energy;

3.3. Area (between 30' and 50') below the DOP and Day-Ahead Schedule AND above the MSS load following down instruction is clarified as Negative MSS Load Following Energy overlapping with positive Optimal Energy. The reason is that, the dispatch “disagrees” with the MSS load following down instruction. Without the economic reason, the DOP would have been at the MSS load following down instruction level. It is brought up because more economic Energy in Real-Time is needed and hence a positive Optimal Energy is incurred in that area.

4. Between 2.5' and 15' in the next hour, the area above Day-Ahead Schedule and standard ramp curve AND below the MSS load following up instruction is clarified as positive MSS Load Following Energy overlapping with negative Optimal Energy. The reason is that, the economic Dispatch “disagree” with the MSS load following up and hence an additional negative Optimal Energy is generated.

Note: for illustration purposes, only energy from Day-Ahead and Real-Time Dispatch schedules are shown. Assume Fifteen-Minute Market Schedules equal Real-Time Dispatch.

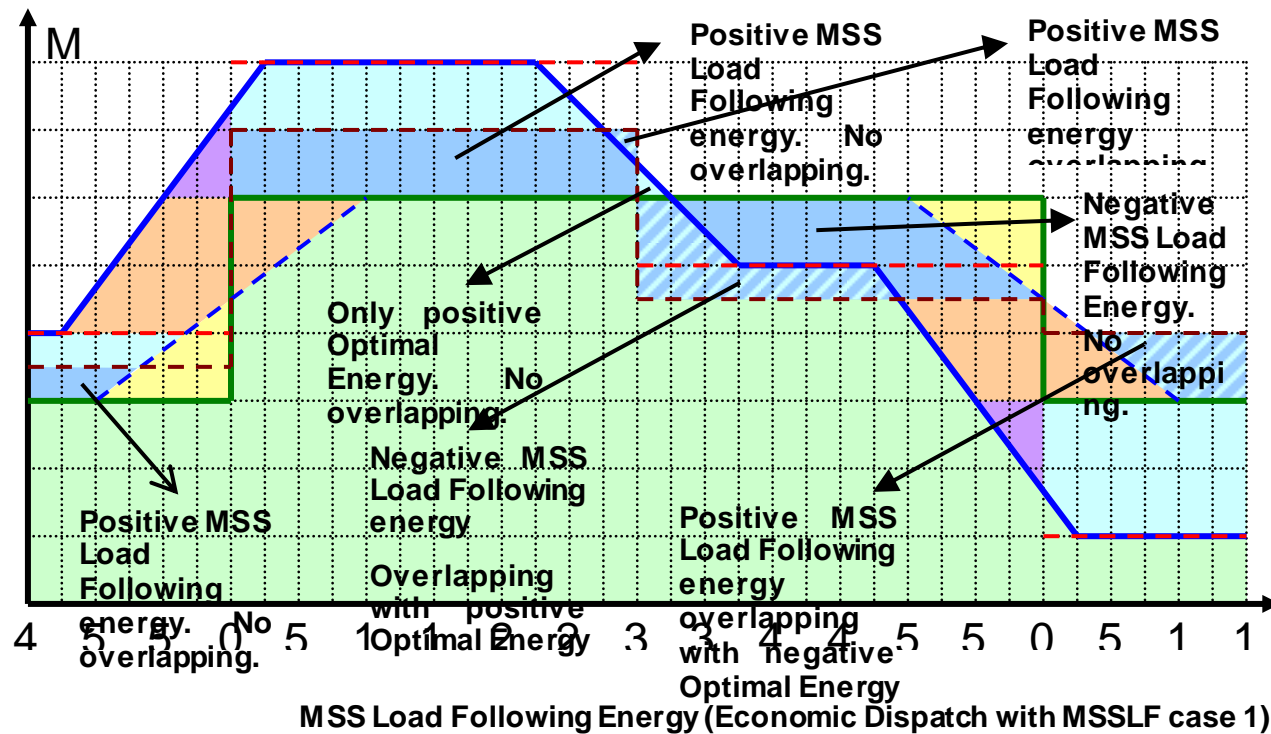
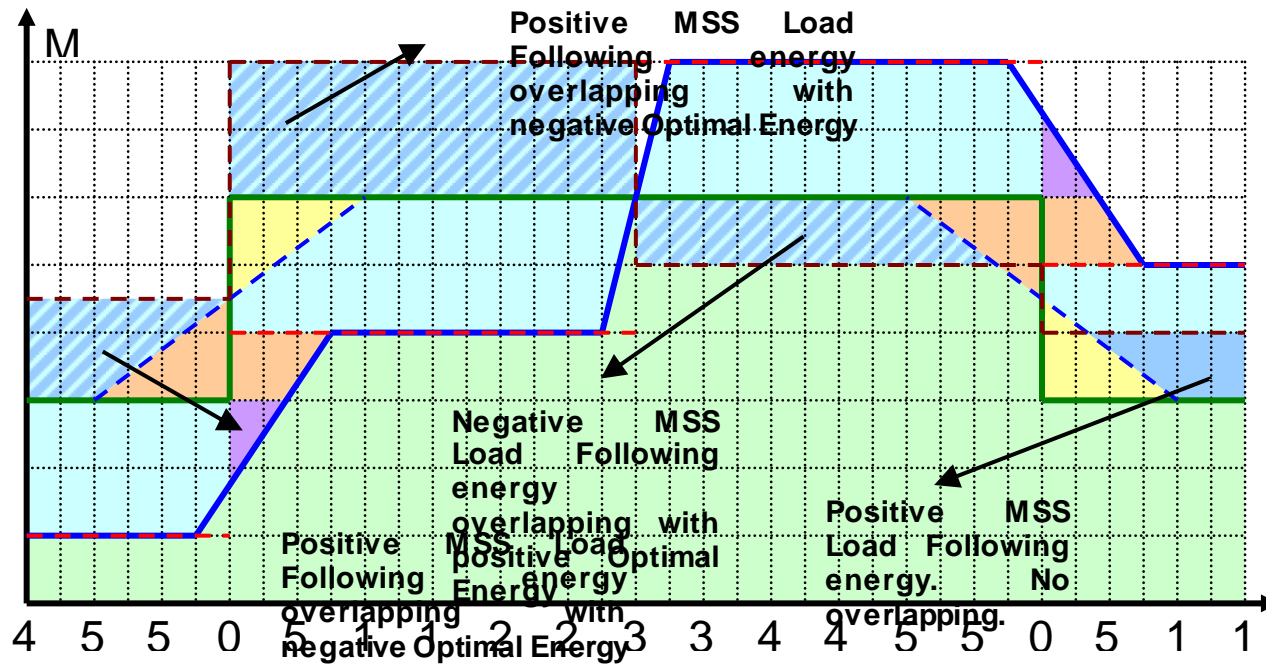

Exhibit C-18:

C-19 takes the comprehensive economic dispatch case in C-6 and adds in the MSS Load Following Instructions. Because of the MSS Load Following Instructions, the clarifications of Expected Energy do change now. As it is shown, the overlapping and non-overlapping cases related MSS Load Following Energy follow the same principle as it is described for C-18.



**Exhibit C-19: MSS Load Following Energy (Economic Dispatch with MSSLF case 2)**

C-20 takes the comprehensive economic dispatch with MSSLF case in C-18 and adds in the Exceptional Dispatch Instructions. Again, when Exceptional Dispatch Instruction “agrees” with the MSS load following instruction, the MSS Load Following Energy does not overlap with Exceptional Dispatch Energy. When they “disagree”, there is a potential of overlapping. Area (between interval 30’ and interval 47.5’ in current hour) below the Exceptional Dispatch and above the LMP MW is clarified as negative MSS Load Following Energy overlapping with the positive Exceptional Dispatch Energy. It is important to note that, there are cases that MSSLF instruction “disagree” with Exceptional Dispatch, however, there is no overlapping between MSS Load

Following Energy and Exceptional Dispatch Energy because the overlapping case is taken care by Optimal Energy. Area between 0' and 15' in the next hour illustrates this case.

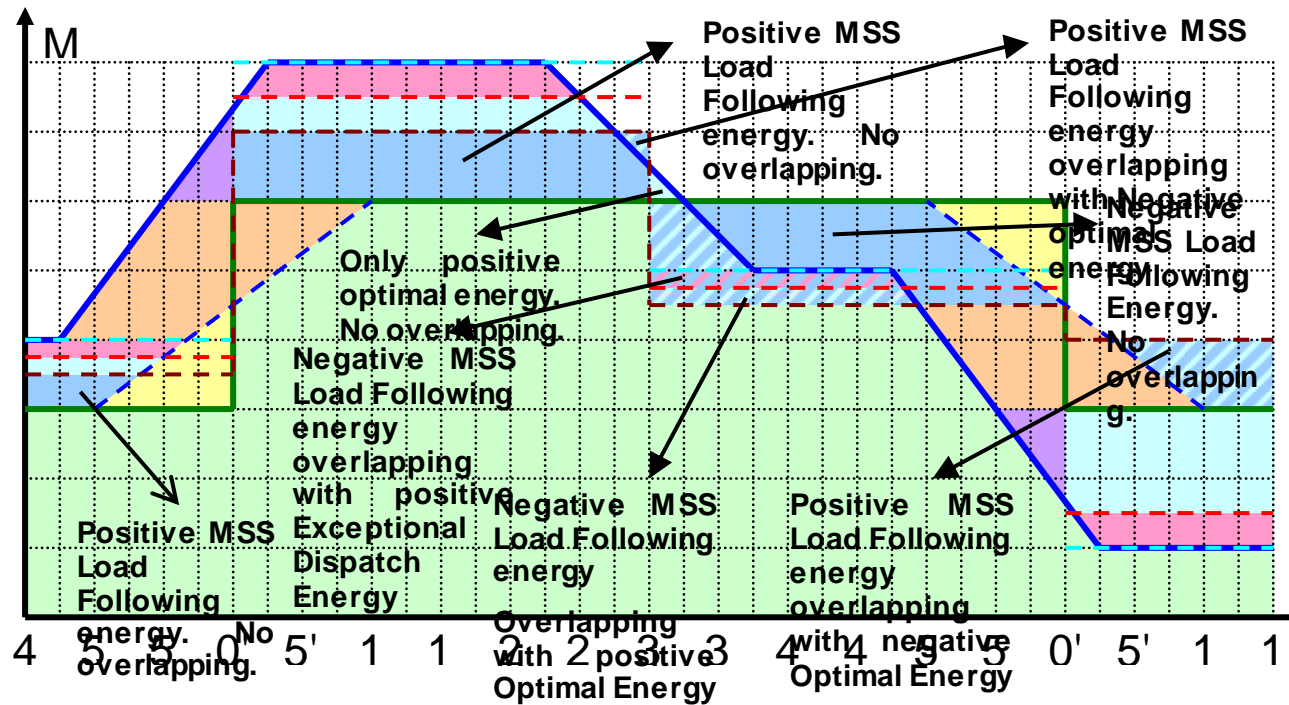

**MSS Load Following Energy (D-18 with Exceptional Dispatch)**

**Exhibit C-20:**

C-21 takes the comprehensive economic dispatch with MSSLF case in C-19 and adds in the Exceptional Dispatch Instructions. In this example, the Exceptional Dispatch Instructions do not change the MSS Load Following Energy. There are intervals in

which Exceptional Dispatch Instructions “disagree” with Exceptional Dispatch Instructions, however, it is already accounted for by Optimal Energy. Area between interval 45’ and 0’ in previous hour, interval 0’ and 57.5 in current hour illustrates such cases.

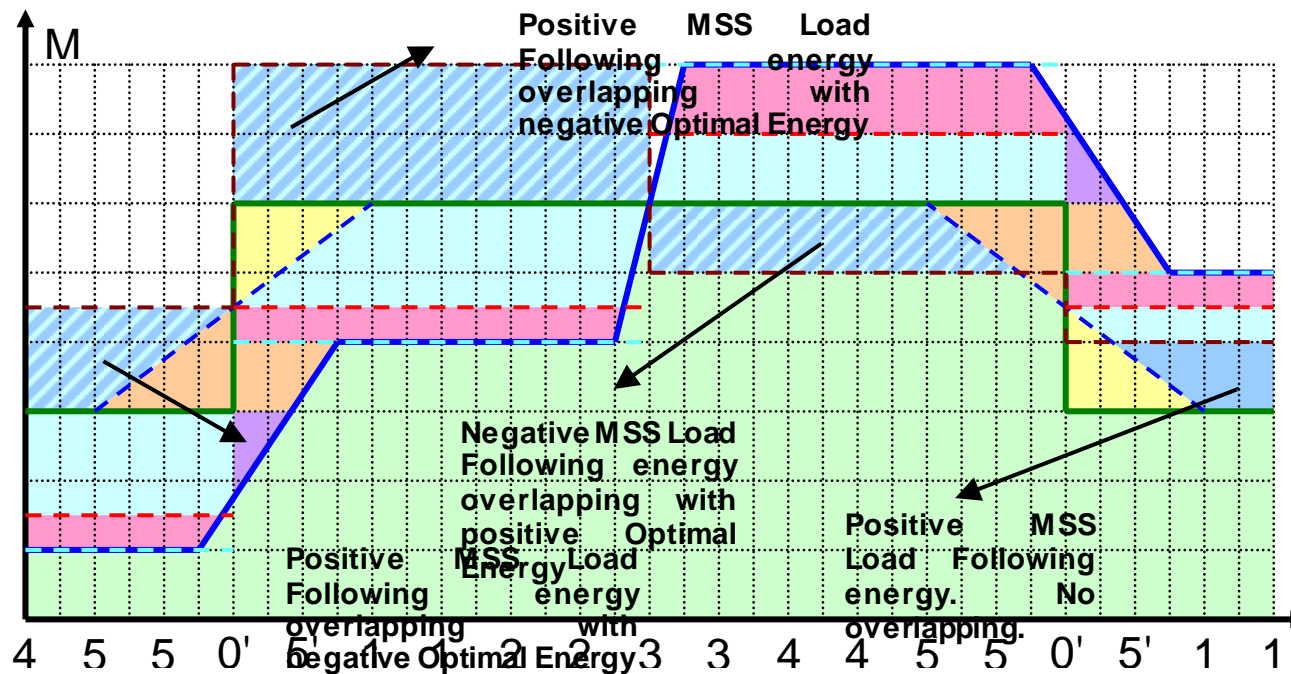

Exhibit C-21: MSS Load Following Energy (D-19 with Exceptional Dispatch)

**C.2.1.35 RMR Energy**

D-22 Illustrates an example in which the “RMR DOP” is calculated based on the combination of DA, RT RMR requirements, DA and STUC commitment schedules and the DOP. The “RMR DOP” is really a curve representing what we believe is dispatch

under the RMR contractual obligation. The RMR energy is simply the area under the “RMR DOP” curve. RMR energy is the energy CAISO will pay based on RMR contract, not based on the market.

In C-22, several cases are illustrated,

Case 1: Interval (45' to 0' for the previous hour)

We have RT RMR requirement and hence the “RMR DOP” is the same as the DOP for those three intervals;

Case 2: Interval (0' to 15' for the current hour)

There is no RT RMR requirement. There is DA RMR requirement which is equal to the DA commitment schedule. We also have STUC commitment schedule equal to the LMP MW. In this case, the “RMR DOP” is still the same as the DOP for those three intervals according to our algorithm;

Case 3: Interval (15' to 30' for the current hour)

There is no RT RMR requirement. There is DA RMR requirement which is equal to the DA commitment schedule. There is no STUC commitment schedule. According to our algorithm, the “RMR DOP” is equal to the Day-Ahead Schedule;

Case 4: Interval (30' to 0' for the current hour)

There is no RT RMR requirement. There is DA RMR requirement which is equal to the DA commitment schedule. There is a STUC commitment schedule equal to the LMP MW. According to our algorithm, this leads to a “RMR DOP” which mostly simulate the DOP curve except in the interval (30' to 32.5') since the STUC commitment schedule is lower than the DOP;

Case 4: Interval (0' to 15' for the next hour)

There is no RT RMR requirement. There is DA RMR requirement which is equal to the DA commitment schedule. There is a STUC commitment schedule equal to the LMP MW. According to our algorithm, this leads to a “RMR DOP” which mostly simulate the DOP curve except in the interval (0' to 2.5') since the STUC commitment schedule is lower than the DOP;



Note: for illustration purposes, only energy from Day-Ahead and Real-Time Dispatch schedules are shown. Assume Fifteen-Minute Market Schedules equal Real-Time Dispatch.

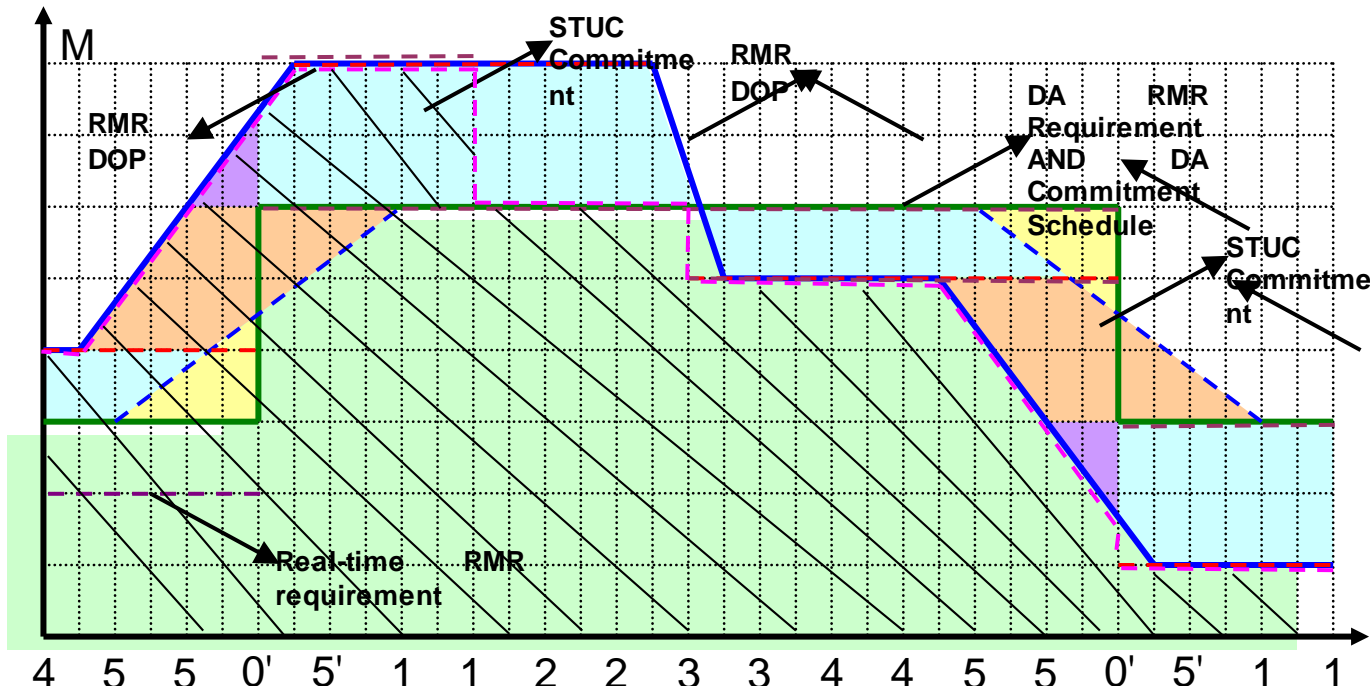

Exhibit C-22: "RMR DOP" curve calculation and RMR energy

### C.3 Ex Post Capacity Allocation

This section describes the ex post capacity allocation of various services onto a Generating Unit Energy Bid and capacity range for the purpose of indexing Instructed Imbalance Energy (IIE) out of these services onto Energy Bid. The capacity allocation rules are consistent with the ones employed in the RTM applications.

The main output of this process is to come up with the following capacity range per market resource and Dispatch Interval,

<i>SRC</i>	Spinning Reserve allocated capacity range.
<i>NSC</i>	Non-Spinning Reserve allocated capacity range.
<i>MEC</i>	Real-time Optimal Energy Capacity range
<i>DAEC</i>	Day-ahead Optimal Energy Capacity range
<i>DeRatedCAP</i>	De-rated Capacity Range

The following notation is used in the following Sections:

<i>LOL</i>	Lower operating limit; it is the minimum load incorporating overrates, which includes the late OMS. MQS gets the original value from RTM and then applies late OMS if applicable.
<i>UOL</i>	Upper operating limit; it is the maximum capacity incorporating de-rates, which includes the late OMS. MQS gets the original value from RTM and then apply late OMS if applicable.
<i>UOL(rtm)</i>	Upper operating limit; it is the maximum capacity incorporating de-rates in RTM if applicable in time. MQS gets this from RTM.
<i>LRL</i>	Lower regulating limit.

---

<i>URL</i>	Upper regulating limit.
<i>LEL</i>	Lower economic limit; it is the starting operating level of the Real-Time Energy Bid.
<i>UEL</i>	Upper economic limit; it is the ending operating level of the Real-Time Energy Bid.
<i>LFD</i>	Load Following Down qualified self-provision capacity. (If exists in RT, take RT, otherwise take DA. In other words, they are not incremental like AS. Hourly for DA and 15-minute for RT)
<i>LFU</i>	Load Following Up qualified self-provision capacity. (If exists in RT, take RT, otherwise take DA. Hourly for DA and 15-minute for RT)
<i>LFI</i>	Validated Load Following Instructions (5 minute based. This value is a part of the DOT breakdown from RTM.).
<i>RD</i>	Regulation Down award; it includes qualified self-provision capacity. (DA + RT. RTM has this total already)
<i>RU</i>	Regulation Up award; it includes qualified self-provision capacity. (DA + RT. RTM has this total already)
<i>SR</i>	Spinning Reserve award; it includes qualified self-provision capacity. (DA + RT. RTM has this total already)
<i>NS</i>	Non-Spinning Reserve award; it includes qualified self-provision capacity. (DA + RT. RTM has this total already)
<i>LFDC</i>	Load Following Down allocated capacity.
<i>LFUC</i>	Load Following Up allocated capacity.
<i>RDC</i>	Regulation Down allocated capacity.

<i>RUC</i>	Regulation Up allocated capacity.
<i>SRC</i>	Spinning Reserve allocated capacity range.
<i>NSC</i>	Non-Spinning Reserve allocated capacity range.
<i>MEC</i>	Real-time Optimal Energy Capacity range
<i>DAEC</i>	Day-ahead Optimal Energy Capacity range
<i>DeRatedCAP</i>	Derated Capacity Range
<i>MinExCap</i>	Minimum Ex-post Capacity
<i>MaxExCap</i>	Maximum Ex-post Capacity

The Generating Unit is considered online if the RTUC status is “ON” in the relevant Dispatch Interval and offline if the commitment status is “OFF”. The Generating Unit is considered on Regulation if the RTM regulating status is “ON” in the relevant Dispatch Interval, and off Regulation if the regulating status is “OFF”. The lower and upper regulating limits are used when the Generating Unit is on Regulation and they are equally or more restrictive than the lower and upper operating limits, unless the latter are modified by de-rates. The Energy Bid range is restricted between the Minimum Load and the maximum capacity, but it may extend beyond the regulating limits, and also beyond the operating limits if they are de-rated.

#### De-rate Capacity:

When considering late OMS case in the ex-post capacity calculation, it is possible that the adjusted UOL is lower than the DOP. This situation reflect the fact that Real-Time dispatch algorithm does not know and hence account for this de-rate so the DOP is higher than what the unit can physically deliver.

In such cases, we never change the Expected Energy calculation. All Expected Energy will be calculated in the same way according to the DOP. What get affected is the energy allocation because now we have a portion of the Expected Energy that will not have a capacity range that corresponds to.

The capacity “De-rate Capacity” is used to solve this problem. Any capacity range above the Spin range to the DOP will be categorized as “De-rate Capacity”. The allocation logic is exactly the same as any other capacity range. The market service type will be filled with “De-rate Capacity” in this case.

Notice that, there can be late OMS for Pmin as well. In such cases, while the late OMS does affect the after the fact calculated LOL and hence “push up” the Optimal Energy, Non-spin and Spin capacity, there is no need to introduce a new service type because the capacity underneath the ME is covered by “Day-Ahead energy capacity”.

### **C.3.1 Online Resource not on Load Following or Regulation**

In this case, the capacity allocation is as follows:

- Spinning Reserve is allocated first from the lower of the upper economic limit or the upper operating limit, and until the higher of the lower economic limit or the lower operating limit.
- Non-Spinning Reserve is allocated next below the Spinning Reserve and until the higher of the lower economic limit or the lower operating limit.

In mathematical terms:

$$\begin{aligned}
 MinExCap &= \max(LOL, LEL) \\
 MaxExCap &= \min(UOL, UEL) \\
 SRC &= \min(SR, MaxExCap - MinExCap) \\
 NSC &= \max(\min(NS, MaxExCap - MinExCap - SRC), 0) \\
 MEC &= \max(MaxExCap - MinExCap - SRC - NSC, 0) \\
 DAEC &= MinExCap \\
 DeRatedCap &= \max((UOL(rtm) - MaxExCap), 0)
 \end{aligned}$$

Exhibit D-23 illustrates a typical scenario under this case.

**Exhibit D-23: Online Resource not on Load Following or Regulation**

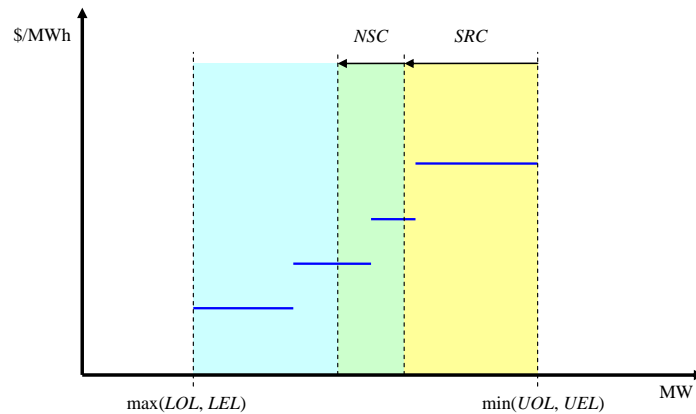

### C.3.2 Online Resource not on Load Following, but on Regulation

In this case, the capacity allocation is as follows:

- Regulation Up and Regulation Down are allocated first and pro rata between the most restrictive of the regulating or operating limits. No Energy Bid is required for Regulation.

- Spinning Reserve is allocated next below the Regulation Up and the upper economic limit, and until the Regulation Down or the lower economic limit.
- Non-Spinning Reserve is allocated next below the Spinning Reserve and until the Regulation Down or the lower operating limit.

In mathematical terms:

$$RDC = \min\left(RD, \frac{RD}{RD + RU} (\min(UOL, URL) - \max(LOL, LRL))\right)$$

$$RUC = \min\left(RU, \frac{RU}{RD + RU} (\min(UOL, URL) - \max(LOL, LRL))\right)$$

$$MaxExCap = \min(\min(UOL, URL) - RUC, UEL)$$

$$MinExCap = \max(\max(LOL, LRL) + RDC, LEL)$$

$$SRC = \min(SR, MaxExCap - MinExCap)$$

$$NSC = \max(\min(NS, MaxExCap - MinExCap - SRC), 0)$$

$$MEC = \max((MaxExCap - MinExCap - SRC - NSC), 0)$$

$$DAEC = MinExCap$$

$$DeRatedCap = \max((UOL(rtm) - MaxExCap), 0)$$

Exhibit C-24 illustrates a typical scenario under this case.

**Exhibit C-24: Online Resource not on Load Following but on Regulation**

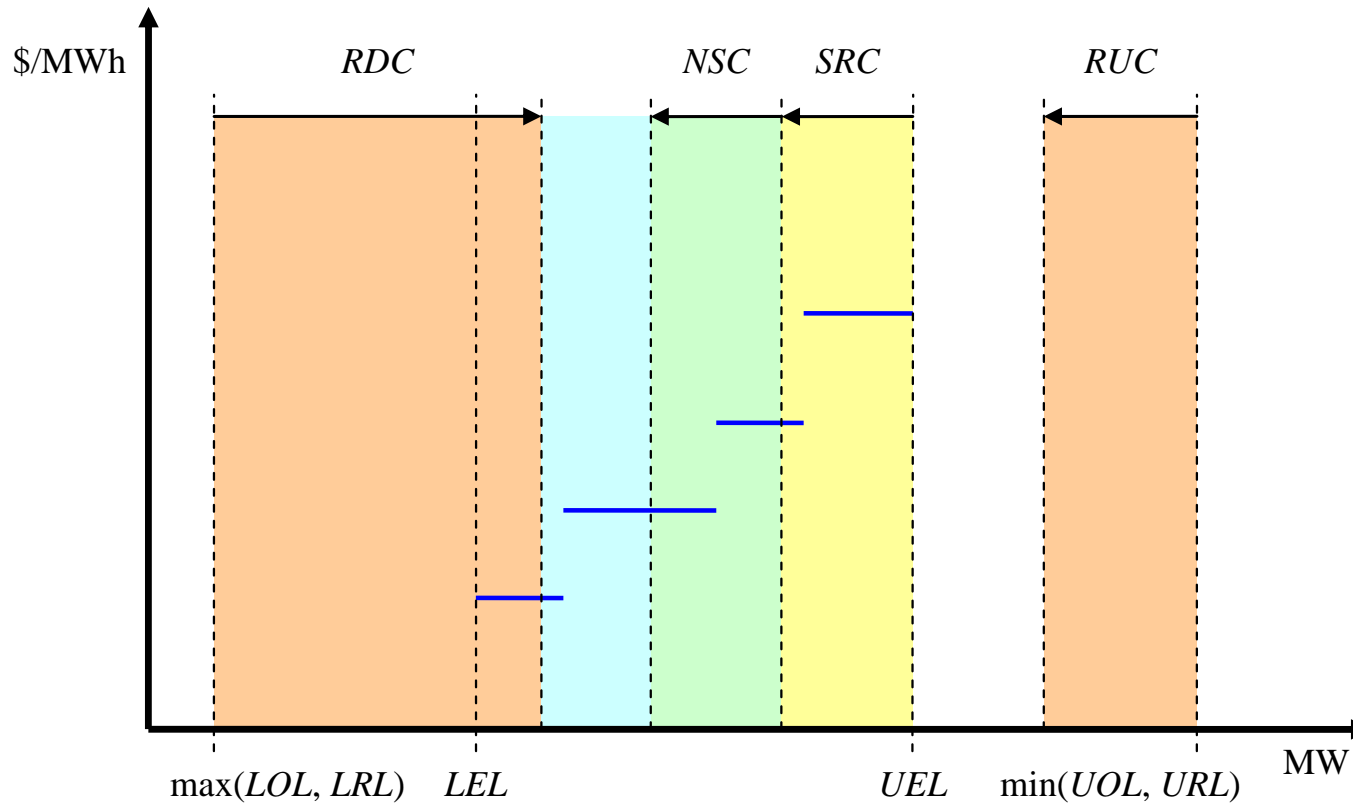

### C.3.3 Online Resource on Load Following, Not on Regulation

In this case, the capacity allocation is as follows:

- Load following up and Load following down are allocated first and pro rata between the most restrictive of the economic or operating limits. An Energy Bid is required for Load Following.



- Spinning Reserve is allocated next below the Load following up and until the Load following down.
- Non-Spinning Reserve is allocated next below the Spinning Reserve and until the Load following down.

In mathematical terms:

$$LFDC = \max(0, LFI + \min\left(LFD, \frac{LFD}{LFD + LFU} (\min(UOL, UEL) - \max(LOL, LEL))\right))$$

$$LFUC = \max(0, \min\left(LFU, \frac{LFU}{LFD + LFU} (\min(UOL, UEL) - \max(LOL, LEL))\right) - LFI)$$

$$MaxExCap = \min(UOL, UEL) - LFUC$$

$$MinExCap = \max(LOL, LEL) + LFDC$$

$$SRC = \min(SR, MaxExCap - MinExCap)$$

$$NSC = \max(\min(NS, MaxExCap - MinExCap - SRC), 0)$$

$$MEC = \max((MaxExCap - MinExCap - SRC - NSC), 0)$$

$$DAEC = MinExCap$$

$$DeRatedCap = \max((UOL(rtm) - MaxExCap), 0)$$

Exhibit C-25 illustrates a typical scenario under this case.

### Exhibit C-25: Online Resource on Load Following, but not on Regulation

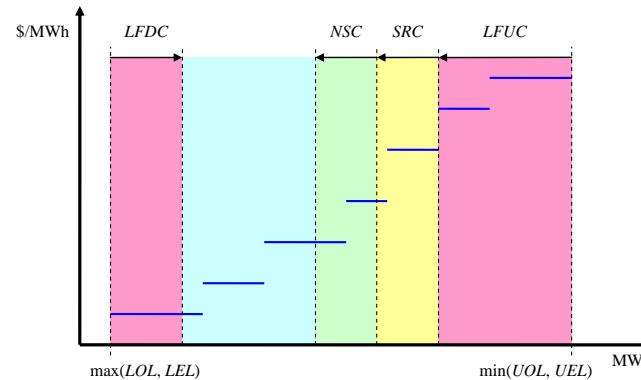

#### C.3.4 Online Resource on Load Following & Regulation

In this case, the capacity allocation is as follows:

- Load following up and Load following down are allocated first and pro rata between the most restrictive of the economic, regulating, or operating limits. An Energy Bid is required for Load Following.
- Regulation Up and Regulation Down are allocated next and pro rata below and above Load following up and Load following down, respectively. In this case, the Energy Bid covers Regulation.
- Spinning Reserve is allocated next below the Regulation Up and until the Regulation Down.
- Non-Spinning Reserve is allocated next below the Spinning Reserve and until the Regulation Down.

In mathematical terms:

$$LFDC = \max(0, LFI + \min\left(LFD, \frac{LFD}{LFD + LFU} (\min(UOL, URL, UEL) - \max(LOL, LRL, LEL))\right))$$

$$LFUC = \max(0, \min\left(LFU, \frac{LFU}{LFD + LFU} (\min(UOL, URL, UEL) - \max(LOL, LRL, LEL))\right) - LFI)$$

$$RDC = \min\left(RD, \frac{RD}{RD + RU} (\min(UOL, URL, UEL) - \max(LOL, LRL, LEL)) - LFDC - LFUC\right)$$

$$RUC = \min\left(RU, \frac{RU}{RD + RU} (\min(UOL, URL, UEL) - \max(LOL, LRL, LEL)) - LFDC - LFUC\right)$$

$$MaxExCap = \min(UOL, URL, UEL) - LFUC - RUC$$

$$MinExCap = \max(LOL, LRL, LEL) + LFDC + RDC$$

$$SRC = \min(SR, MaxExCap - MinExCap)$$

$$NSC = \max(\min(NS, MaxExCap - MinExCap - SRC), 0)$$

$$MEC = \max((MaxExCap - MinExCap - SRC - NSC), 0)$$

$$DAEC = MinExCap$$

$$DeRatedCap = \max((UOL(rtm) - MaxExCap), 0)$$

Exhibit C-26 illustrates a typical scenario under this case.

**Exhibit C-26: Online Resource on Load Following and Regulation**

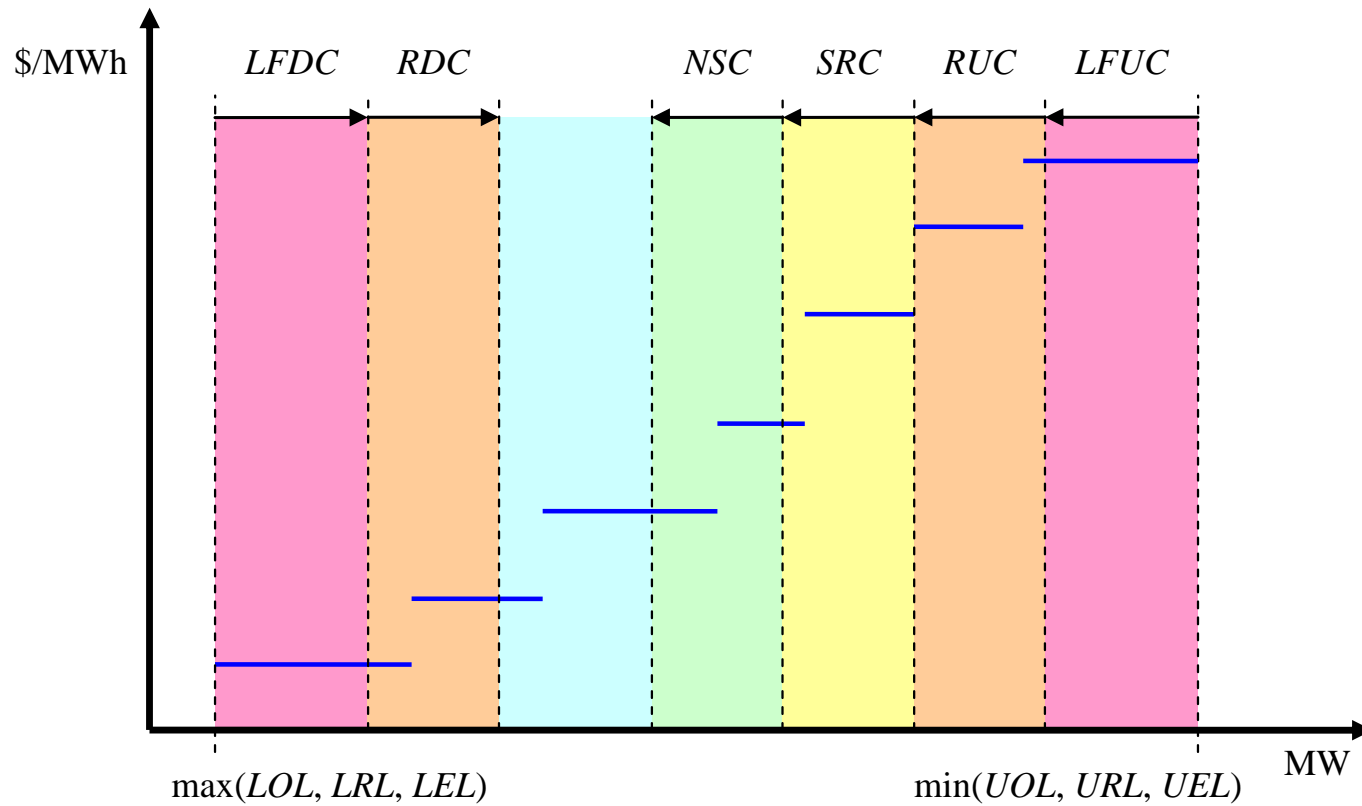

### C.4 Expected Energy Allocation

In order to support various compliance and settlement functions, we will need a combined break-down of various market services, Expected Energy and Day-Ahead/Real-Time Energy Bid curve. This break-down list is the so-called “Expected Energy Allocation”.

The breakdown will look like the following and each unique combination of Expected Energy type, market service type and the corresponding bid segment will uniquely determines one unique energy amount.

Expected Energy Type	Market Service Type	Bid Price	Energy
Expected Energy Types	What the market offers that has relationship to settlement bid cost recovery and compliance	Corresponding Price with matched bid segment	Break-down energy amount

#### C.4.1 Expected Energy Types and Market Service Types

In MRTU, the market service types simply represent the various commodities supported by the market that has relationship to Settlement Bid Cost Recovery and compliance calculation. These market service types breakdown is corresponding to the capacity range derived from the ex-post capacity allocation described in D.4

The reason that derate capacity, market energy capacity and day-ahead energy capacity are calculated is to determine spinning reserve and non-spinning reserve capacity because those capacities do affect the ex-post spin and non-spin capacity range. The expected energy within the capacity range of spinning reserve and non-spinning reserve capacities are also referred “spin energy” and “non-spin energy” and used in Compliance for Spin and non-spin No Pay. Market Service types are only used by Compliance for spin and non-spin “no pay” calculations.

They are as it follows,

- SR* Spinning Reserve Capacity range.
- NR* Non-Spinning Reserve Capacity range.
- ME* Market Energy Capacity
- DAC* Day-ahead Capacity
- DEC* Derated Capacity

Market Participants will be able to review all Expected Energy Categories in OASIS and CMRI. All energy types can be verified against the Market Participant's settlements statements to validate both Day Ahead HASP and Real Time Charge Codes. The following matrix outlines how each report shall display the various types of Energy Types. Note that for the definition of the Exceptional Dispatch types, please refer Settlements and Billing BPM for CC6470 – Instructed Imbalance Energy Settlement.

<b>Expected Energy Category</b>	<b>OASIS</b>	<b>CMRI – Expected Energy</b>	<b>CMRI – Expected Energy Allocation Details</b>
Day Ahead Scheduled Energy	DASE	DASE	DASE
Day Ahead Bid Awarded Energy	DABE	DABE	n/a
Day Ahead Self Schedule Energy	DSSE	DSSE	n/a
Day Ahead Minimum Load Energy	DMLE	DMLE	n/a

Day Ahead Pumping Energy	DAPE	DAPE	n/a
Base Schedule Energy	BASE	BASE	BASE
Total Expected Energy	TEE	TEE	n/a
Optimal Energy <sup>1</sup>	OE	OE	OE
Standard Ramping Energy	SRE	SRE	SRE
Ramping Energy Deviation	RED	RED	RED
RMR Energy	RMRE	RMRE	n/a
Residual Energy	RE	RE	RE
Minimum Load Energy <sup>1</sup>	MLE	MLE	MLE
Pumping Energy <sup>1</sup>	PE	PE	n/a
Real Time Self Scheduled Energy	RTSSE	RTSSE	RTSSE
OMS Energy <sup>1</sup>	SE	SE	SE
MSS Load Following Energy	MSSLFE	MSSLFE	MSSLFE
Exceptional Dispatch Energy <sup>1</sup>	TMODEL	EDE	TMODEL
Exceptional Dispatch Energy - TMODEL 1 <sup>1</sup>	TMODEL1	EDE	TMODEL1

Exceptional Dispatch Energy – TMODEL2 <sup>1</sup>	TMODEL2	EDE	TMODEL2
Exceptional Dispatch Energy – TMODEL3 <sup>1</sup>	TMODEL3	EDE	TMODEL3
Exceptional Dispatch Energy – TMODEL4 <sup>1</sup>	TMODEL4	EDE	TMODEL4
Exceptional Dispatch Energy – TMODEL5 <sup>1</sup>	TMODEL5	EDE	TMODEL5
Exceptional Dispatch Energy – TMODEL6 <sup>1</sup>	TMODEL6	EDE	TMODEL6
Exceptional Dispatch Energy – TMODEL7 <sup>1</sup>	TMODEL7	EDE	TMODEL7
Exceptional Dispatch Energy - SYSEMR <sup>1</sup>	SYSEMR	EDE	SYSEMR
Exceptional Dispatch Energy – SYSEMR1 <sup>1</sup>	SYSEMR1	EDE	SYSEMR1
Exceptional Dispatch Energy - TEMR <sup>1</sup>	TEMR	EDE	TEMR
Exceptional Dispatch Energy - RMRR <sup>1</sup>	RMRR	EDE	RMRR



Exceptional Dispatch Energy - RMRS <sup>1</sup>	RMRS	EDE	RMRS
Exceptional Dispatch Energy - RMRT <sup>1</sup>	RMRT	EDE	RMRT
Exceptional Dispatch Energy - NonTModel <sup>1</sup>	NonTMod	EDE	NonTMod
Exceptional Dispatch Energy – TORETC <sup>1</sup>	TORETC	EDE	TORETC
Exceptional Dispatch Energy – TORETC1 <sup>1</sup>	TORETC1	EDE	TORETC1
Exceptional Dispatch Energy - ASTEST <sup>1</sup>	ASTEST	EDE	ASTEST
Exceptional Dispatch Energy - TEST <sup>1</sup>	TEST	EDE	TEST
Exceptional Dispatch Energy - VS <sup>1</sup>	VS	EDE	VS
Exceptional Dispatch Energy - BS <sup>1</sup>	BS	EDE	BS
Exceptional Dispatch Energy - OMS <sup>1</sup>	OMS	EDE	OMS

Manual Dispatch Energy - PASTEST1	MDE	MDE	PASTEST
Manual Dispatch Energy – BS <sup>1</sup>	MDE	MDE	PBS
Manual Dispatch Energy – NONTMOD <sup>1</sup>	MDE	MDE	PNONTMOD
Manual Dispatch Energy - PRMRRC2	MDE	MDE	PRMRRC2
Manual Dispatch Energy - PRMRT <sup>1</sup>	MDE	MDE	PRMRT
Manual Dispatch Energy – SYSEMR <sup>1</sup>	MDE	MDE	PSYSEMR
Manual Dispatch Energy – TEMR <sup>1</sup>	MDE	MDE	PTEMR
Manual Dispatch Energy – TEST <sup>1</sup>	MDE	MDE	PTEST
Manual Dispatch Energy – TMODEL <sup>1</sup>	MDE	MDE	PTMODEL
Manual Dispatch Energy – VS <sup>1</sup>	MDE	MDE	PVS
RMRRRC2	RMRRRC2	EDE	RMRRRC2
OTHER	OTHER	EDE	OTHER

<sup>1</sup>Separate allocations for 15 minute and 5-minute dispatches will be reported.

### C.4.2 Allocation Logic

There are two steps in this allocation:

#### Step 1: Ex-post Capacity Allocation for every market resource and 5 minute interval

This has been described in D4. The final result leads to the following table (hypothetical data)

-- Example assumes no derate and hence no de-rated capacity exists.

Market Service Type	MW range
Spinning Reserve Capacity	50 – 55MW
Spinning Reserve Capacity	45 – 50MW
Non Spinning Reserve Capacity	40 – 45MW
Non Spinning Reserve Capacity	30 – 40 MW
Optimal Energy Capacity	20 – 30 MW
Day-ahead Energy Capacity	0 – 20 MW

#### Step 2: Stack up the table in the order that it is shown to the left of the Expected Energy curve and, apply the Real-Time Energy Bid segment to Real-Time Expected Energy AND the Day-Ahead Energy Bid segment to Day-Ahead Expected Energy

Per Expected Energy area, market service type, DA/RT Energy Bid segment, this breaks down the Expected Energy area into further detail and the MWH related to that area is calculated. This so called “Slicing and Dicing” method is the same as we

deployed in Phase 1B except the difference that Day-Ahead Energy Bid curve is used for DA energy and Real-Time Energy Bid curve is used for RT energy.

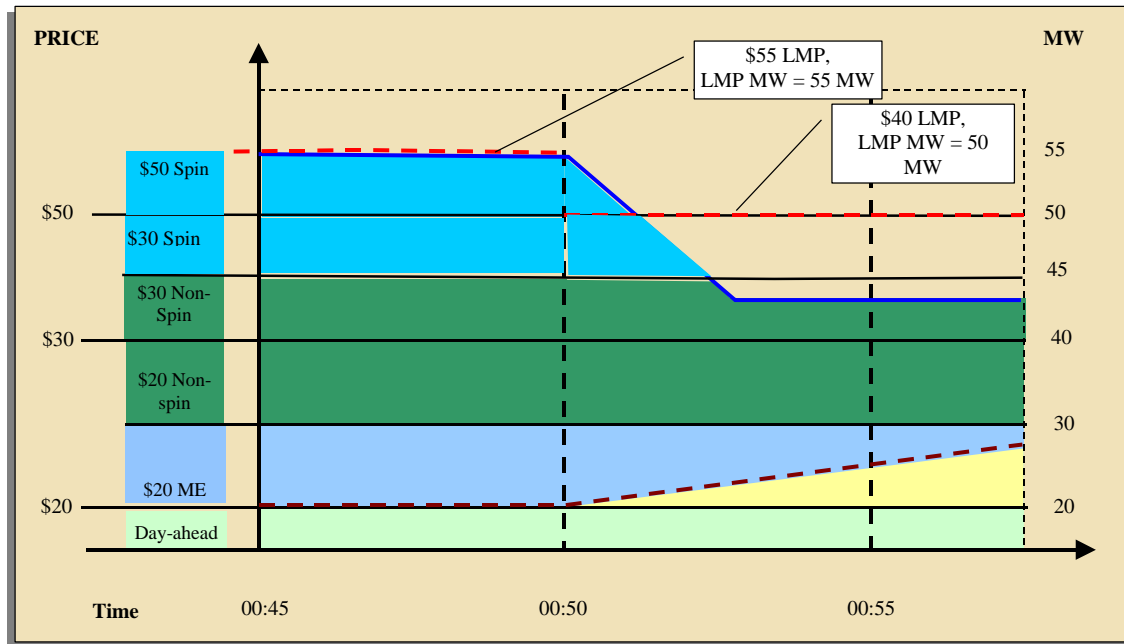

**Exhibit C-27: “Slice and Dice” for ancillary service allocation – Economic Dispatch**

The final output will be like the following table (The numbers are hypothetical)

Expected Energy Type	Market Service Type	Bid Price	Energy
Optimal Energy	Spinning Reserve	\$50	0.415MWH

	Capacity		
Optimal Energy	Spinning Reserve Capacity	\$30	0.415MWH
Optimal Energy	Non Spinning Reserve Capacity	\$30	0.415MWH
Optimal Energy	Non Spinning Reserve Capacity	\$20	0.83MWH
Optimal Energy	Optimal Energy Capacity	\$20	0.83MWH
Day-ahead Energy	Day-ahead Energy Capacity	\$20	1.66MWH

### Residual and Exceptional Energy

When dealing with Residual Imbalance Energy, the bid segment needs to come from the reference hour's bid, not the current hour's bid, except as noted in section **Error! Reference source not found..**

Exceptional Dispatch Energy is listed with its description of the Exceptional Dispatch Instruction type. When there are multiple Exceptional Dispatch Instructions for the same interval, ONLY the binding Exceptional Dispatch Instruction needs to be considered and outputted in the EE calculation.

### "NO BID" -- When Bid price is NULL

Because of the nature of Exceptional Dispatch Instructions, it is possible that an instruction will NOT have a bid segment associated with it (the so-called out of market) case. In such cases, the Expected Energy type will be still filled in with the Exceptional Dispatch Energy type while the Bid price will be filled as "NULL". This would indicate to downstream systems that there is no match for the big curve.

To further more illustrate the NO BID scenario, there are also other cases that there is no Energy Bid at all for certain intervals. For example, there is the case that unit ramping from a hour with bid into the next hour without bid, a ramping energy deviation could occur in the first few intervals of the next hour. In such cases, use the NULL for bid price. The Expected Energy type will stay as whatever applies for that energy portion. BASE Schedule Energy by nature does not have a Bid price. The Day-Ahead energy capacity and de-rate capacity sections typically come with NULL price. However, some part of those capacity ranges can come with a bid price because they overlaps with the bid curve.

Exhibit C-28 further illustrates how Expected Energy allocation is done in a more comprehensive example.

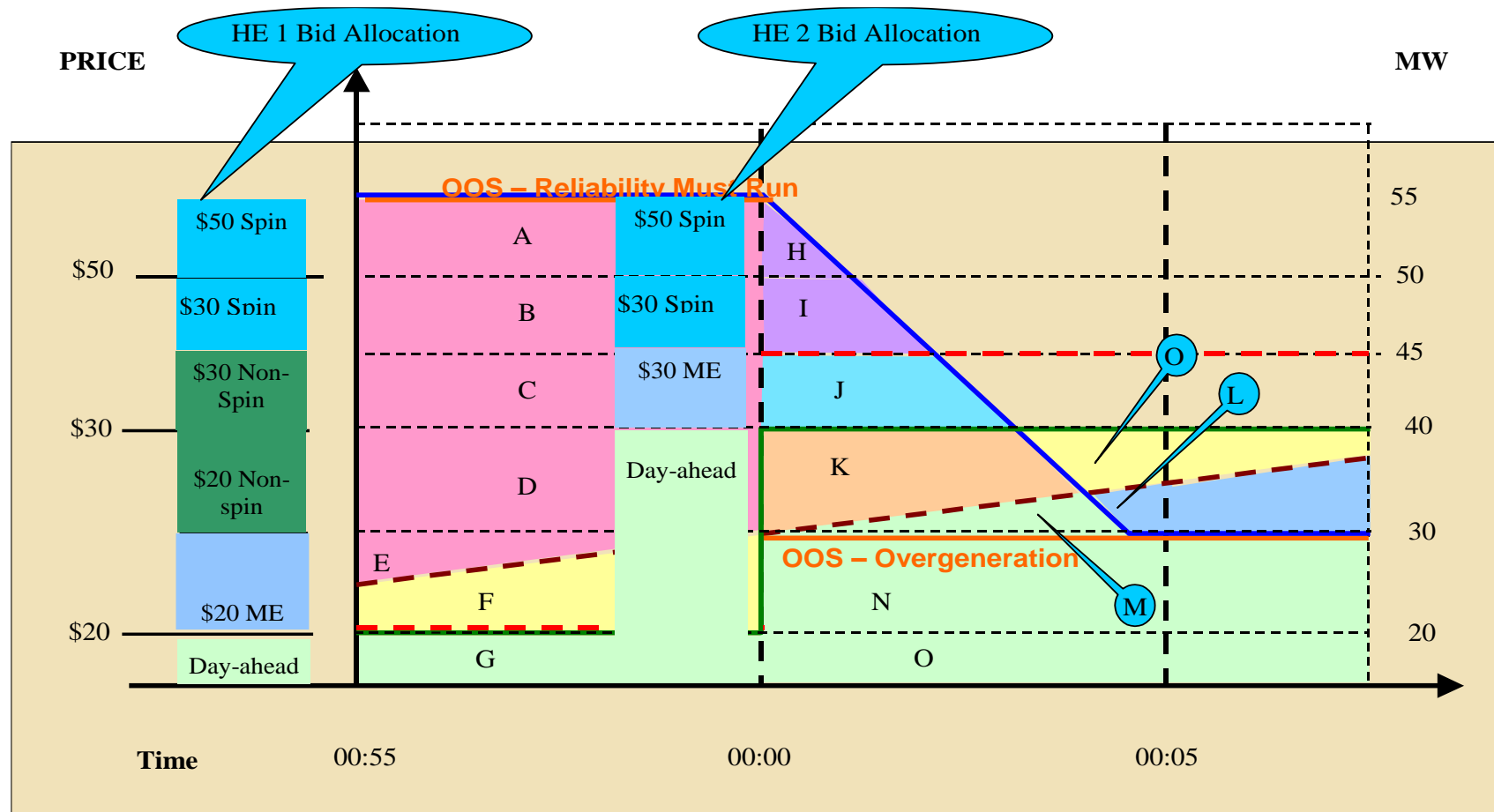

Exhibit C-28 Exceptional Dispatch Energy and more complicated ramping scenarios

The output of Exhibit D-28 for interval 00:55 to 00:00 (HE 1) will be something like the following table (This time we use area label to indicate)

Expected Energy Type	Market Service Type	Bid Price	Energy
EDE – Reliability Must Run	Spinning Reserve	\$50	A
EDE – Reliability Must Run	Spinning Reserve	\$30	B
EDE – Reliability Must Run	Non Spinning Reserve	\$30	C
EDE – Reliability Must Run	Non Spinning Reserve	\$20	D
EDE – Reliability Must Run	Optimal Energy	\$20	E
Standard Ramping Energy	Optimal Energy	\$20	F
Day-ahead Energy	Day-ahead Energy	\$0	G

The output of Exhibit D-28 for interval 00:00 to 00:05 (HE 2) will be something like the following table (This time we use area label to indicate)

Expected Energy Type	Market Service Type	Bid Price	Energy
Residual Energy	Spinning Reserve	\$50	H
Residual Energy	Spinning Reserve	\$30	I
Optimal Energy	Optimal Energy	\$30	J
Ramping Energy Deviation	Day-ahead Energy	\$0	K
Standard Ramping Energy	Day-ahead Energy	\$0	O (Negative)
Optimal Energy	Day-ahead Energy	\$0	L (Negative)
EDE – Over-generation	Day-ahead Energy	\$0	M (Negative)
Day-ahead	Day-ahead Energy	\$0	N + O



---

Energy			
--------	--	--	--

## C.5 Market Data Correction

Prior to calculating Expected Energy, a review of the Trading Day's Market results is performed. After the Day-Ahead Market application (IFM) and the Real-Time Market application (RTM) conclude for the Trading Day, the Market results are evaluated by CAISO Market Operations Engineers and Market data corrections are performed, if appropriate.

For more details, refer to Section 8 of the BPM .

## C.6 Publish Expected Energy Calculation

CAISO initially publishes Expected Energy at Trading Day plus one (T+1) Calendar Day. The remaining Expected Energy publication schedule is consistent with the settlement schedule provided in Section 2.3.2 of BPM for Settlements. CAISO will publish Expected Energy no later than 2 business days in advance of the settlements schedule. This is to allow for Settlement Statement processing time and validation. The data in Expected Energy shall match the Settlement Statements when published.

Expected Energy is available on a secure basis to each Market Participant via the CMRI.

## C.7 Multi-Stage Generating Resource Expected Energy

### C.7.1 Real-Time Minimum Load Energy Calculation for Multi-Stage Generating Resources

The formulas for the Expected Energy calculation and allocation logic for Multi-Stage Generating Resources do not differ from those for non Multi-Stage Generating Resources. The only difference in the Expected Energy calculation for a Multi-Stage Generating Resource is the calculation for the Real-Time Minimum Load Energy. This is to account for the possibility that an MSG's Minimum Load is different between the Day-Ahead Market and the Real-Time Market as a result of the commitment of different MSG Configurations. The two instances where the calculation of Real-Time Minimum Load Energy is different for a Multi-Stage Generating Resource are:

- 1- For any given Settlement Interval, if the Day-Ahead Market and Real-Time Market have different committed MSG Configurations, and the Real-Time MSG Configuration Minimum Load is greater than Day-Ahead Schedule, then the Real-Time Minimum Load Energy will be the Energy below the Real-Time MSG Configuration Minimum Load and above Day-Ahead Schedule. The Day-Ahead Minimum Load Energy will correspond to the Day-Ahead MSG Configuration Minimum Load as shown below:

Note: for illustration purposes, only energy from Day-Ahead and Real-Time Dispatch schedules are shown. Assume Fifteen-Minute Market Schedules equal Real-Time Dispatch.

## RT Configuration Above DA Configuration

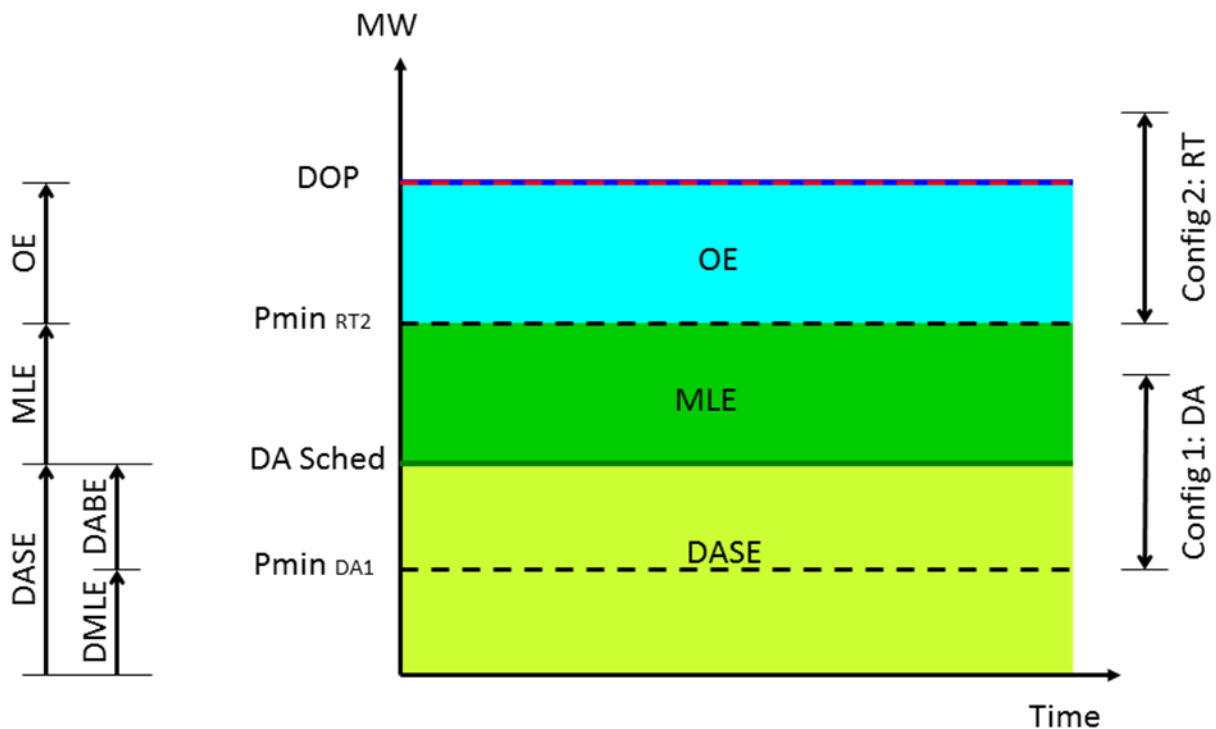
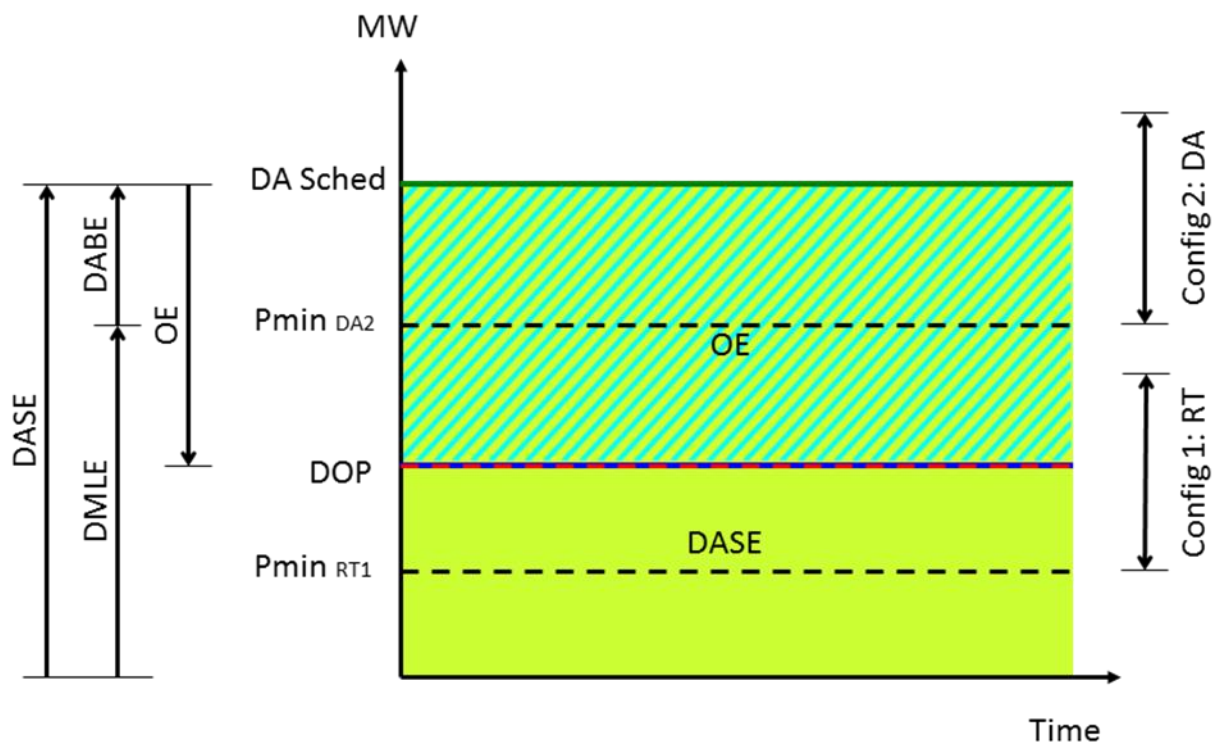

**Exhibit C-29: Example of Real-Time Minimum Load Energy for Multi-Stage Generating Resource**

- 2- If the Day-Ahead Market and Real-Time Market have different committed MSG Configurations, and the Real-Time MSG Configuration Minimum Load is less than the

Day-Ahead Schedule, there will be no Real-Time Minimum Load Energy. The Day-Ahead Minimum Load Energy will correspond to the Day-Ahead MSG Configuration Minimum Load as shown below:

## RT Configuration Below DA Configuration



### Exhibit C-30: No Real-Time Minimum Load Energy: Multi-Stage Generating Resource where Real-Time MSG Configuration is Below Day-Ahead MSG Configuration

Note: in the scenario where the Real-Time MSG Configuration is Below the Day-Ahead MSG Configuration, Expected Energy and Bid allocation is calculated the same as for non-Multi-Stage Generating Resources. However, for purposes of Bid Cost Recovery calculations, the total Real-Time Bid allocation for any negative OE type Expected Energy allocated to capacity within the Day-Ahead MSG Configuration will be included as part of the total Real-Time Minimum Load Cost and qualified accordingly. This has been implemented

in order to simplify the Expected Energy allocation calculation for Multi-Stage Generating Resources. The simplified calculation only considers allocation for capacity within the Real-Time MSG Configuration, and does not include the capacity of the Day-Ahead MSG Configuration.

Example: Consider the following:

- Day-Ahead Schedule is 250 MW,
- Day-Ahead MSG Configuration  $P_{min}$  is 200 MW,
- Real-Time Energy Bid in the DA MSG Configuration at \$40/MWh (single segment)
- Minimum Load Cost in the Day-Ahead MSG Configuration is \$5,000/hr,
- Minimum Load Cost in the Real-Time configuration is \$3,000/hr.

In addition to allocating the Real-Time Minimum Load Cost allocated to Bid Cost Recovery as the difference between Real-Time and Day-Ahead values, or  $\$3,000 - \$5,000 = -\$2,000$ , the ISO will also include in the Real-Time Minimum Load Cost allocation the energy bid cost (using Real-Time Energy Bids) in the Day-Ahead MSG Configuration, calculated as  $(200 - 250) * \$40 = -\$2,000$ , for a total of  $-\$4,000$ . On a per Settlement Interval basis the Minimum Load Cost allocation would be  $-\$4,000/12 = -\$333.33$ .

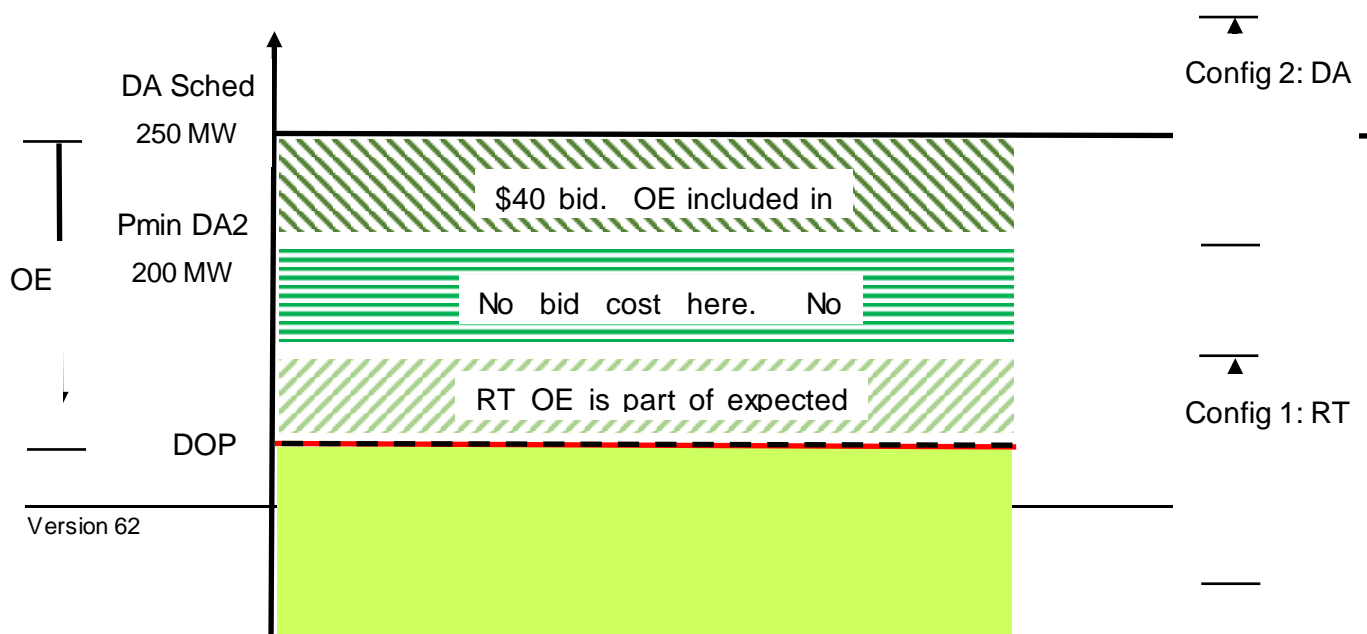

**Exhibit C-30a: Allocation of decremental energy from the Day-Ahead committed configuration. Multi-Stage Generating Resource where Real-Time MSG Configuration is Below Day-Ahead MSG Configuration**

In the same scenario where the Real-Time MSG Configuration is Below the Day-Ahead MSG Configuration, but there is an outage or derate on the Day-Ahead awarded configuration, the CAISO will allocate the outaged capacity using the LMP from the Fifteen Minute Market. The principle is that the resource should not get BCR when on outage. In lieu of explicit outage energy, the LMP allocation will effectively negate any BCR, since the energy costs will be set equal to the revenues.

Example – Consider the same unit with a Real-Time outage on the Day-Ahead configuration:

- FMM LMP = \$45 for all four intervals

Energy bid cost for the Day-Ahead configuration is  $(200-250) * \$45 = -\$2,250$ . Total Minimum Load Cost is  $-\$2,000$  (see previous example)  $-\$2,250 = -\$4,250$ . On a per Settlement Interval basis the Minimum Load Cost allocation would be  $-\$4,250/12 = -\$354.17$ .

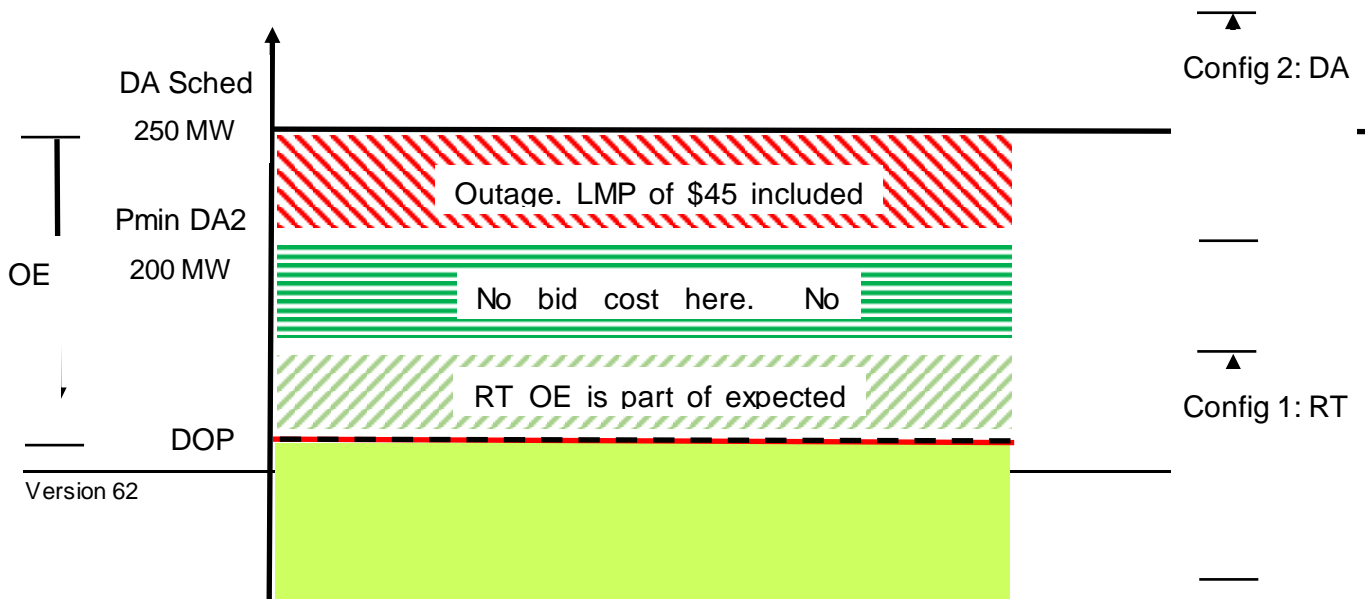

**Exhibit C-30b: Allocation of decremental energy from the Day-Ahead committed configuration during an outage in Real-Time. Multi-Stage Generating Resource where Real-Time MSG Configuration is Below Day-Ahead MSG Configuration**

### **C.7.2 Real-Time Economic Dispatch Levels for Multi-Stage Generating Resources**

The calculation of the upper and lower Real-Time Economic Dispatch levels for Multi-Stage Generating Resources do not differ from those for non MSG resources. However, the following rules apply in addition to the calculations detailed in section C.2.1.1.14 above.

For Multi-Stage Generating Resources, the Real-Time Economic Dispatch levels must always fall within the operating range of the Real-Time active MSG Configuration. The formula used to calculate these levels when there is no Real-Time Energy Bid for the active MSG Configuration has been updated to comply with this convention. The formula is as follows:

$$RTLED = RTUED = \text{Min} \{ P_{\text{max RT Config}}, \text{Max} [ \text{DAS DA Config}, P_{\text{min RT Config}} ] \}$$

The formula in section C.2.1.1.14 used when a Real-Time Energy Bid is present can be applied to Multi-Stage Generating Resources without any changes. However, it is important to note that the Real-Time Energy Bid Curve of the Real-Time active MSG Configuration will be used as the input to that formula. Therefore, the calculated Real-Time Economic Dispatch levels will never exceed the operating range of the Real-Time active MSG Configuration. In the case where a Multi-Stage Generating Resource is dispatched uneconomically (for example due to Exceptional

Dispatch) the Real-Time active MSG Configuration may be a different MSG Configuration than the economic dispatch. (See figures C-31 and C-32 below for illustration of examples.)

### Progression of RT Economic Dispatch Levels With Un-Economic Exceptional Dispatch Instruction (Decremental)

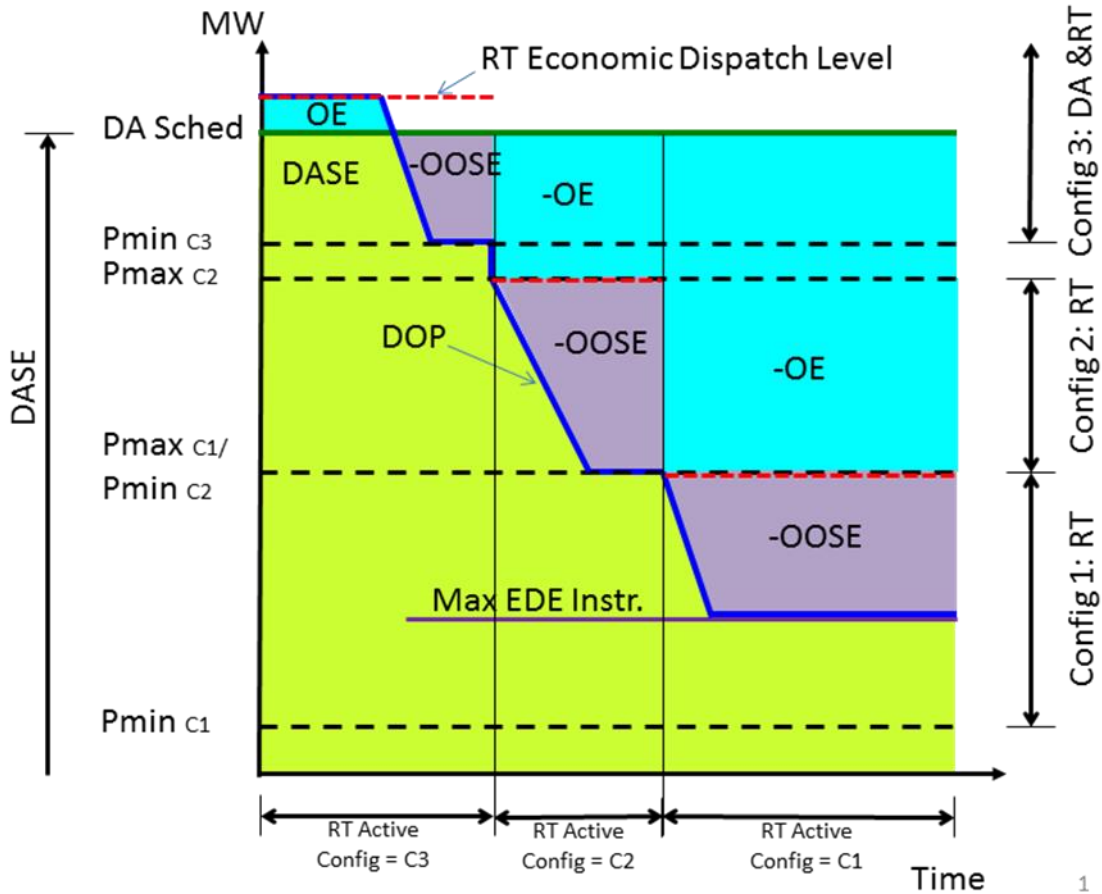

**Exhibit C-31: Real-Time Economic Dispatch Levels with Decremental Exceptional Dispatch Instruction**

### Progression of RT Economic Dispatch Levels With Un-Economic Exceptional Dispatch Instruction (Incremental)

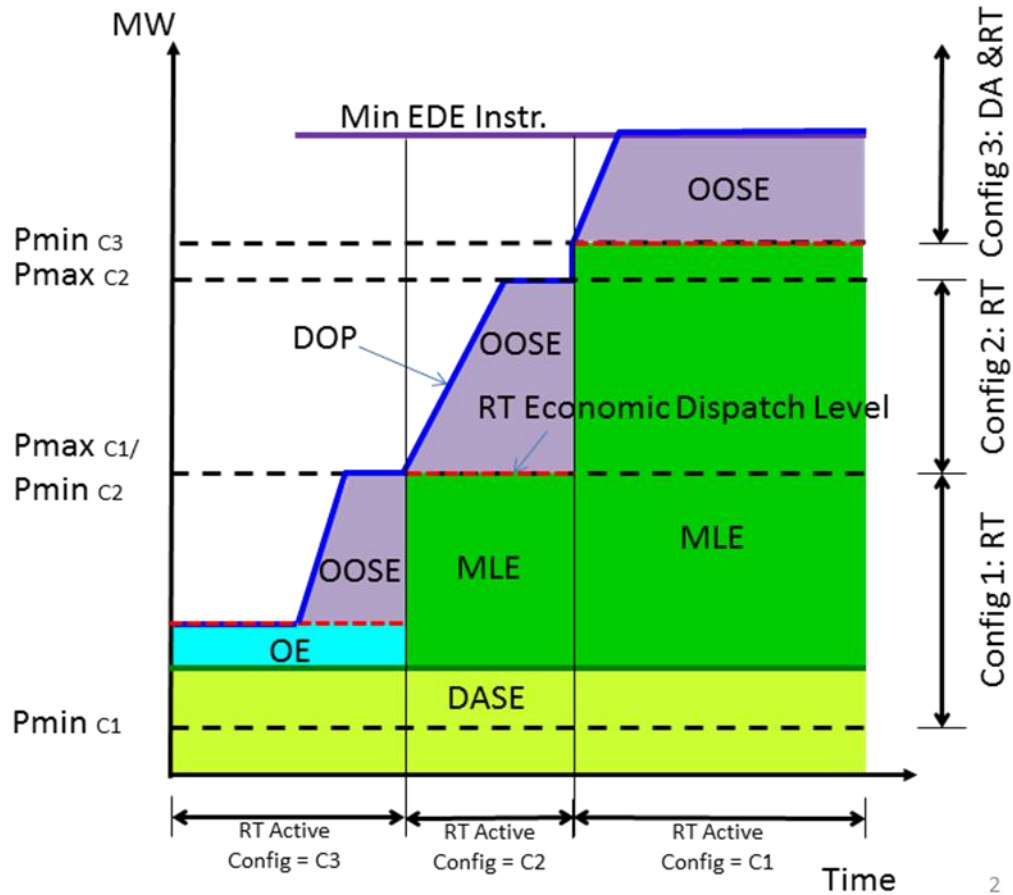

**Exhibit C-32: Real-Time Economic Dispatch Levels with Incremental Exceptional Dispatch Instruction**

### C.7.3 Residual Imbalance Energy for Multi-Stage Generating Resources

As detailed in section C.1, Residual Imbalance Energy is assigned the Real-Time Energy Bid price from the reference hour. For Multi-Stage Generating Resources if the Real-Time active MSG Configuration is the same during the intervals of the Residual Imbalance Energy and the reference hour then the Real-Time Energy Bid price from that same MSG Configuration during



---

the Reference Hour will be assigned to the Residual Imbalance Energy as appropriate. This is essentially the same process used for non-Multi-Stage Generating Resources.

For Multi-Stage Generating Resources it is possible that the Residual Imbalance Energy may be in a Real-Time active MSG Configuration that was not active in the reference hour (see Figure C-33 below.) In such cases the Real-Time Energy Bid price from the last or next active MSG Configuration will be assigned to the Residual Imbalance Energy depending on the direction of the reference hour. If the reference hour is the prior hour (as in Figure C-33) then the Real-Time Energy Bid price from the last active MSG Configuration in the reference hour will be assigned to the Residual Imbalance Energy. If the reference hour is the hour after then the Residual Imbalance Energy will use the Real-Time Energy Bid price from the first active MSG Configuration in the next hour.

It is important to note that the range of the Real-Time Energy Bid Curve from the active MSG Configuration in the reference hour may exclude some or all of the range of the Residual Imbalance Energy. In the case of two over-lapping configurations some of the Residual Imbalance Energy will be assigned the Real-Time Bid Price from the reference hour and appropriate configuration. But some of the Residual Imbalance Energy will not be assigned any Energy Bid price and will instead be settled using the Resource Specific Settlement Interval LMP for each interval. For example, in figure C-33 below, the Residual Imbalance Energy is in active configuration 2. The last active MSG Configuration from the reference hour is configuration 3, the range of which overlaps with Configuration 2. The Real-Time Energy Bid price from configuration 3 will be assigned to the portion of the Residual Imbalance Energy that overlaps with the range of configuration 3. The remaining Residual Imbalance Energy will not be assigned any Bid Price and will be settled using the Resource Specific Settlement Interval LMP values for each interval.

If there was no overlap between configuration 3 and configuration 2 then all of the Residual Imbalance Energy would be settled at the Resource Specific Settlement Interval LMP.

## Residual Expected Energy After Real-Time Configuration Transition

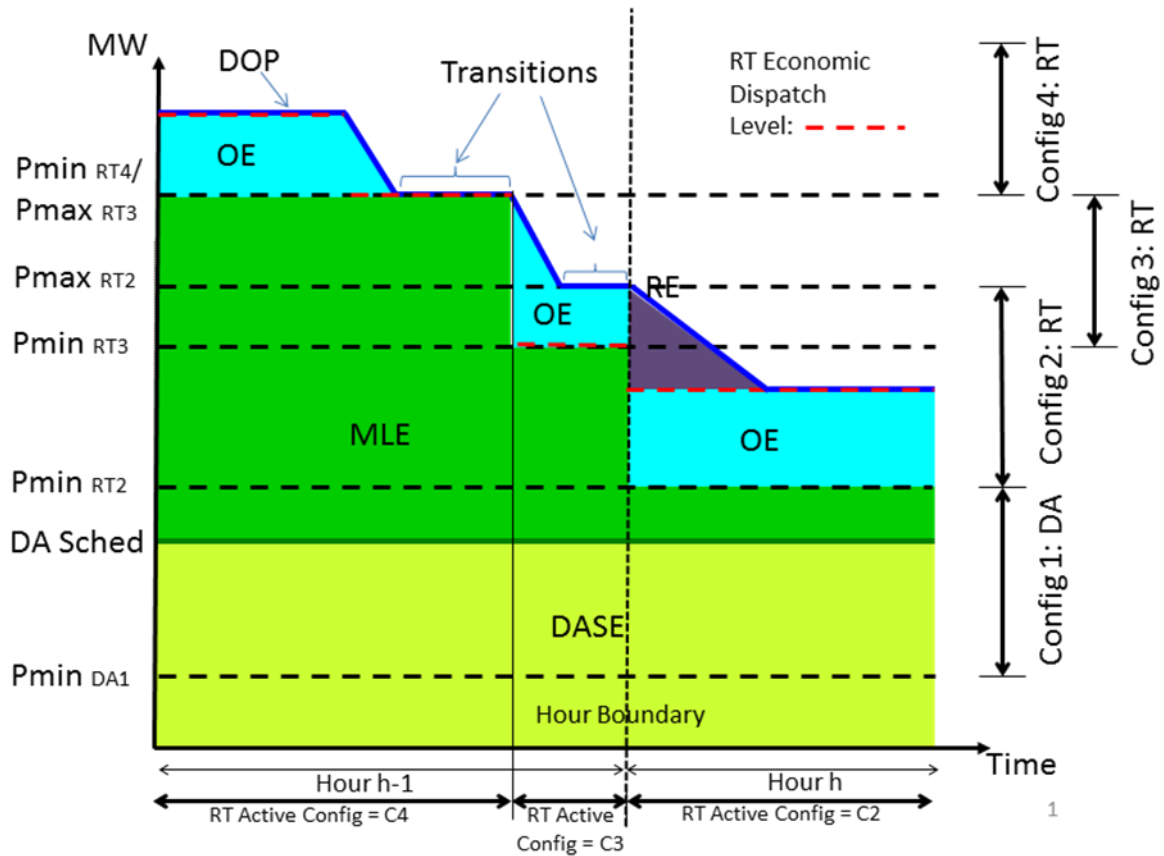

**Exhibit C-33: Residual Imbalance Energy After Real-Time Configuration Transition**

## **Attachment D**

# **COMMITMENT COST DETERMINATION**

## **D. Commitment Cost Determination**

### **D.1 Introduction**

In order to support the bid cost recovery process, the relevant commitment cost per market and resource will need to be determined. This determination will first derive the Self-Commitment Periods based on the bid set and relevant inter-temporal constraints. This results into the separation of ISO commitment period versus self-commitment period. At the end, the relevant commitment cost will be calculated based on the determined ISO commitment and self-commitment period and relevant cost allocation rules. In essence, the bid cost for the resource within the determined self-commitment periods will not be included the bid cost recovery.

The commitment cost covers the following resources,

1. Startup cost and minimum load cost for generators including pump storage resources in generation mode and tie generators;
2. Pumping cost and pump shutdown cost for participating loads and pump storage resources in pumping mode.

In summary, this determination process will include the following three steps:

1. ELC/IFM/RUC self-commitment type determination (sections D3, D4);
2. Real-time self-commitment type determination (D6);
3. BCR commitment cost determination including individual cost dollar amount and eligibility (D7).

---

## D.2 General Principles of Self Commitment Determination

CAISO will determine the commitment type for each time interval. The commitment type shall be either “Self-Commitment” or CAISO-Commitment.”.

The Commitment Types shall be determined for ELC, IFM, RUC and RTUC for each time interval. The time interval in the ELC, IFM and RUC is an hour, and the time interval in RTUC is 15 minutes. The manual commitment by the CAISO in RTD (OOS) as Exceptional Dispatch should be considered as CAISO commitment if the OOS instruction is in its time horizon and also reported as OOS instructions.

The Commitment Types shall be determined for Generators, Tie Generators, Pump-Storage Units in Generating Mode, Pump-Storage in Pumping Mode, and Participating Load.

The key is how to determine Self-Commitment (including extended Self-Commitment); once Self-Commitment is determined, CAISO Commitments can be determined readily by excluding the Self-Commitments from the Commitment periods.

The following general principles apply to all CAISO Markets (IFM, RUC, HASP, STUC, FMM, RTUC and RTM).

- For a unit that is not a Fast Start unit, a time interval is considered a Self-Commitment interval if the unit has in its Clean Bid an energy self-schedule, EIM Base Schedule, load following up/down capacity or any AS self-provision (i.e., regulation up/down, spinning reserve, non-spinning reserve) in the interval or in other intervals if it is determined by inference that the unit must be on in the interval due to the unit’s physical constraints such as Minimum Up Time (MUT), Minimum Down Time (MDT), Maximum Daily Startup (MDS).
- For a unit that is a Fast Start unit (i.e. a unit that can provide non-spin when offline), a time interval is considered a Self-Commitment interval if the unit has in its Clean Bid an energy self-schedule, EIM Base Schedule, load following up/down capacity or any AS self-provision except non-spinning reserve (i.e., regulation up/down and spinning reserve) in the interval or in other intervals if it is determined by inference that the unit must be on in the interval due to the unit’s

physical constraints such as Minimum Up Time (MUT), Minimum Down Time (MDT), Maximum Daily Startup (MDS).

- Self-commitment extension should be done to satisfy MUT first, MDT second, and MDS last.
- For purposes of this section, submittal of an EIM Base Schedule for EIM resources shall be treated the same as a self-commitment in the IFM.

Note, operator manual commitment should be considered as CAISO Commitment even though such manual commitment may be treated in a similar way as energy self-schedules. If the CAISO decides to commit resource using the software automatically or manually, the commitment should be considered as CAISO commitment.

In order to better describe our business rules and examples, following conventions are used when describing commitment periods and their types.

Commitment Period – is a time period specified by a start-time/date and an end-time/date within the time horizon of a market process in which the commitment statuses are determined. The start-time is considered in the Commitment Period and the end-time is considered not in the Commitment Period; mathematically, a Commitment Period is denoted by [start-time, end-time).

Commitment Period Set – is a collection of Commitment Periods as its elements. In the rest of the document, the Commitment Period Set is also referred to as Commitment Periods although a Commitment Period Set can have zero, one or more elements in the collection.

We use the following symbols in the following sections to simplify the description:

#### **Definition of Commitment Periods and Set Operators**

Symbol	Meaning
[ ... )	Time period, for example [1, 5) means starting at 1 (including 1) and

	ending at 5 (excluding 5).
{ ... }	Set
+	Union set operator, for example $\{[1, 2), [3, 5)\} + \{[2, 5)\} = \{[1, 5)\}$
*	Intersection set operator, for example $\{[1, 3)\} * \{[2, 5)\} = \{[2, 3)\}$
-	Minus set operator, for example $\{[1, 3)\} - \{[2, 5)\} = \{[1, 2)\}$
{ ... } <sub>A-AppName</sub>	Commitment Period Set determined by a specific market application; the types are defined in Table D.2. For example $\{SCUC\}_{A-IFM}$ means SCUC commitment type determined by IFM application.
{ ... } <sub>S-AppName</sub>	Commitment Period Set provided through the services for a specific market application; the types are CAISO, SELF and UC. For example $\{CAISO\}_{S-IFM}$ means the CAISO IFM Commitment Periods.

The following examples in this section illustrate in general how MUT, MDT and MDS are used to extend the self-commitment periods. In these examples, hourly intervals are used but the concepts illustrated by the examples also apply to RTM where the intervals are 15-minutes. In the figures of these examples, S.C.P.E stands for Self-Commitment Period Extension.

## D 2.1 Minimum Up Time (MUT) Examples

### Example 1 Basic MUT Self-Commitment period extension

A unit is 'ON' from 8:00 to 16:00. It has a self-schedule of 6 hours from 8:00 to 14:00. Its MUT is 8 hours. Since the submitted self-schedule is less than the MUT of the resource, the Self-Commitment Period is extended to 8:00 to 16:00 instead of 8:00 to 14:00. Note, when a Self-Commitment Period can be extended in both directions, always extend it to the hours after the self-schedule hours first because the 'ON' hours before the self-schedule hours may not be due to the MUT but be due to an economic reason. This is illustrated in Figure 1.

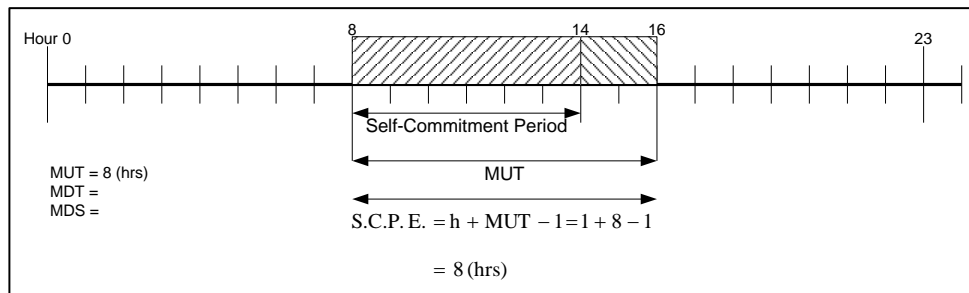

**Figure 1 Basic MUT Self-Commitment period extension**

### Example 2 Forward and Backward MUT Self-Commitment period extension

A unit is 'ON' from 7:00 to 16:00. It has a self-schedule of 6 hours from 8:00 to 14:00. Its MUT is 9 hours. Since the submitted self-schedule is less than the MUT of the resource, the Self-Commitment Period is extended to 8:00 to 16:00 first then to 7:00 to 16:00 to meet the MUT. This is illustrated in Figure 2.

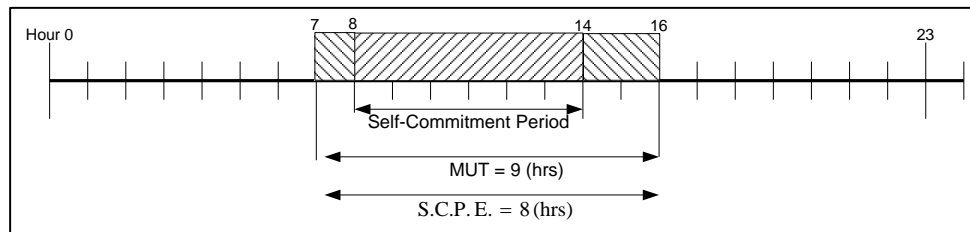

**Figure 2 Forward and Backward MUT Self-Commitment period extension**

## D 2.2 Minimum Down Time (MDT) Examples

### Example 3 Basic MDT Self-Commitment period extension

A unit is 'ON' from 8:00 to 18:00. The original self-commitment periods are from 8:00 to 11:00 and from 15:00 to 18:00. Its MDT is 6 hours. Since the hours between the two original self-commitment periods are only 4 hours that is less than the MDT, the two original self-commitment periods are merged into one from 8:00 to 18:00. This is illustrated in Figure 3.



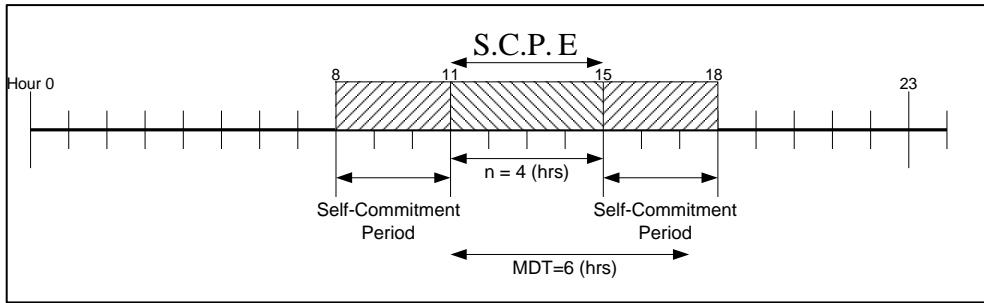
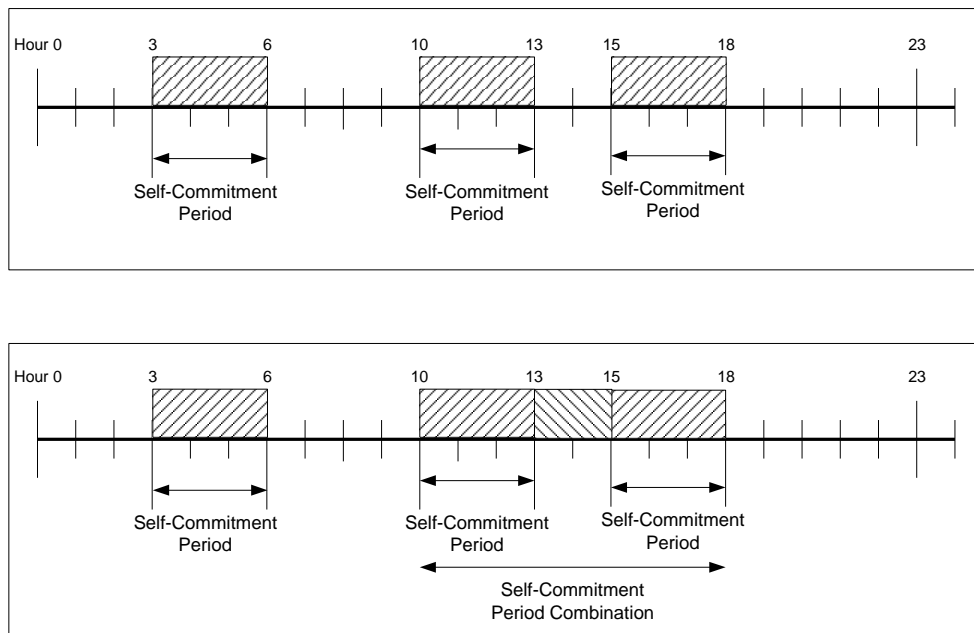

**Figure 3 Basic MDT Self-Commitment period extension**

**D 2.3 Maximum Daily Start-Ups (MDS) Examples**

**Example 4 Basic MDS Self-Commitment period extension**

A unit is 'ON' from 3:00 to 18:00. The original self-commitment periods are from 3:00 to 6:00, 10:00 to 13:00, and 15:00 to 18:00. Its MDS is 2. Since the number of the original self-commitment periods is 3 (exceeding the MDS), then the original self-commitment periods with the smallest time separation are merged to eliminate the violation. This is illustrated in Figure 4.



**Figure 4 Basic MDS Self-Commitment period extension – first example**

### Example 5 MDS Self-Commitment period extension sequence

In the above example (MDS\_1), if the second original self-commitment period is from 9:00 to 12:00 instead of 10:00 to 13:00, the time separation between the first and the second original self-commitment period is the same as the time separation between the second and the third original self-commitment period. In this case, the first two original self-commitment periods based on the time sequence are merged to eliminate the violation. This is illustrated in Figure 5

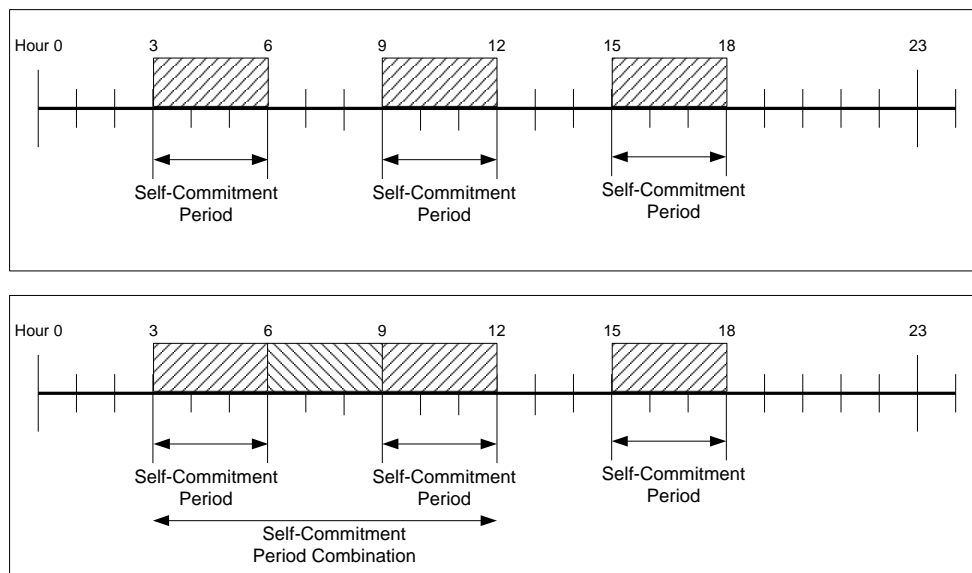

**Figure 5 MDS Self-Commitment period extension sequence**

### Example 6 not counting commitment period that is a continuation of previous day

If a unit initially is 'ON' and the first original Self-Commitment Period is from 0:00, the unit's MDS will be increased by 1 before it is used to determine if the MDS limitation is violated. For example, a unit is initially 'ON' and it continues to be 'ON' from 0:00 to 18:00. It has three original self-commit periods. The first original self-commit period is from 0:00 to 4:00. Its MDS is 2. After increasing the MDS by 1, the MDS limitation is not violated any more. No merge is necessary. This is illustrated in Figure 6.

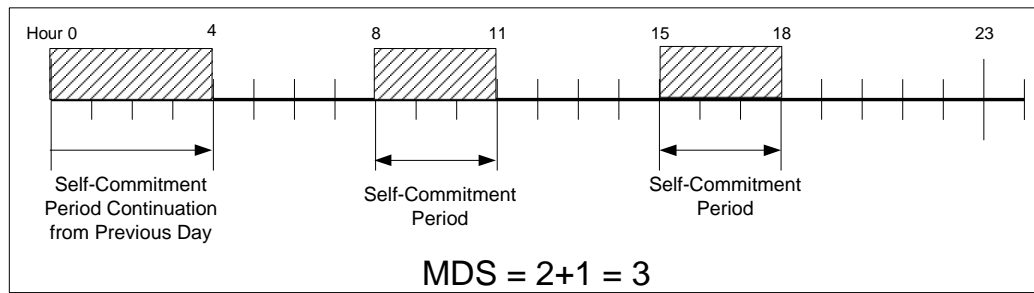

**Figure 6 Not counting commitment period that is a continuation of previous day**

**Example 7 MDS Self-Commitment period extension in a more complex scenario**

If in the previous example, the first original Self-Commitment Period is from 1:00 to 4:00 instead of 0:00 to 4:00, the rule used in the first example will be applied here first, i.e., the first original Self-Commitment Period will be extended to 0:00 to 4:00 to join the commitment period of the previous day. Then the unit's MDS will be increased by 1. This is illustrated in Figure 7.

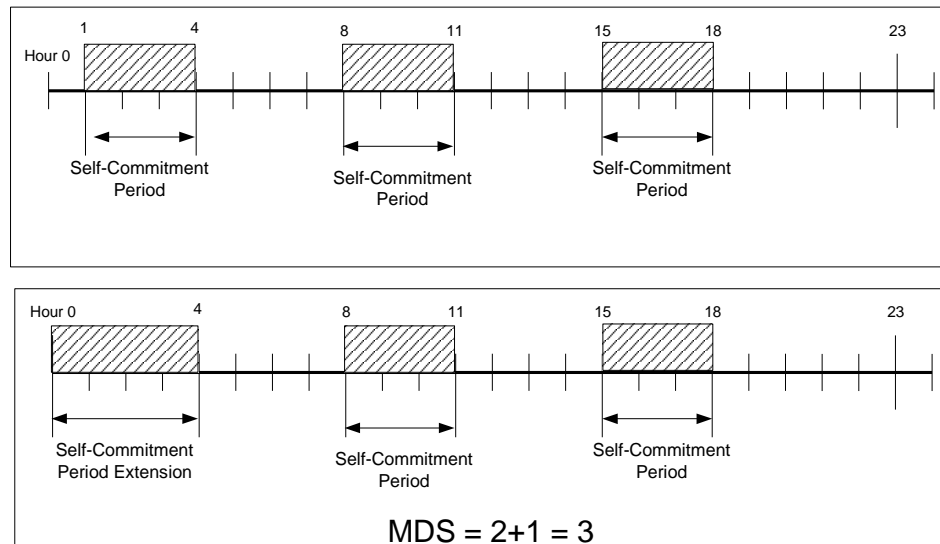

**Figure 7 MDS Self-Commitment period extension in a more complex scenario**

**D.3 CAISO/Self-Commitment Extension in ELC – Examples**

### D.3.1 Minimum Up-Time (MUT) Examples

#### Example 8 IFM Self-commitment Extension in ELC because of MUT

This example illustrates that an IFM Self-commitment period is extended to meet MUT in ELC.

Assumptions:

- SUT = 19 hours
- MUT = 3 hours
- MDT = 20 hours
- Energy self-schedules submitted for the period of [4/4/07 22:00, 4/4/07 24:00]; in ELC the energy self-schedules submitted for 4/4/07 are also used as energy self-schedules for [4/5/07 22:00, 4/5/07 24:00).
- The IFM commits the unit for the period of [4/4/07 22:00, 4/4/07 24:00] and determined that this period is IFM Self-commitment
- There is no additional commitment in RUC
- The ELC commits the unit for the periods of {[4/4/07 22:00, 4/5/07 01:00] , [4/5/07 22:00, 4/5/07 24:00]}

The entire ELC Commitment Periods will be ELC Self-commitment Periods because the periods of {[4/4/07 22:00, 4/4/07 24:00), [4/5/07 22:00, 4/5/07 24:00]} are covered by energy self-schedules, and the period [4/4/07 24:00, 4/5/07 01:00] is extended because of MUT of 3 hours. This is illustrated in Figure 8.

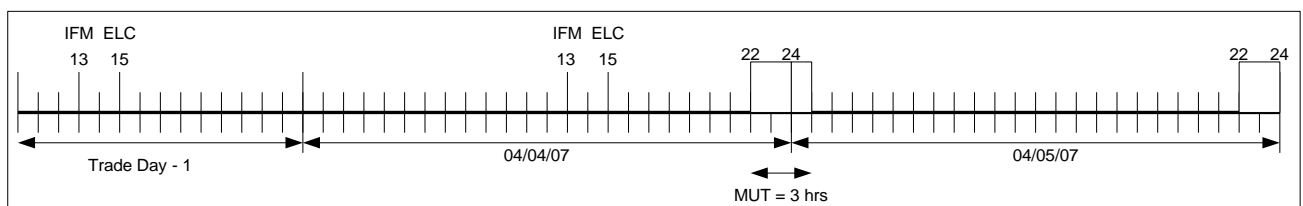

**Figure 8 IFM Self-commitment Extension in ELC because of MUT**

#### Example 9 IFM Self-Schedule Extension in ELC because of MUT and copied self-schedules

This example illustrates that an IFM Self-commitment period is extended to meet MUT in ELC because of the self-schedules copied to the second day.

Assumptions:

- SUT = 19 hours
- MUT = 3 hours
- MDT = 20 hours
- Energy self-schedule submitted for the period of [4/4/07 0:00, 4/4/07 2:00) and this is accepted by SIBR because of existing energy schedules at the end of the previous day, i.e., 4/3/07.
- The IFM commits the unit for the period of [4/4/07 0:00, 4/4/07 2:00) and determined that this period is IFM Self-commitment
- There is no additional commitment in RUC
- The ELC commits the unit for the periods of {[4/4/07 0:00, 4/4/07 2:00) , [4/4/07 22:00, 4/5/07 4:00)}

The ELC Self-commitment Periods should be [4/4/07 0:00, 4/4/07 2:00) and [4/5/07 0:00, 4/5/07 3:00). This is illustrated in Figure 9.

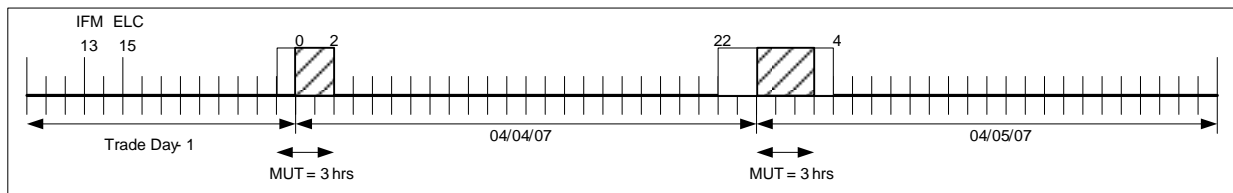

**Figure 9 IFM Self-Schedule Extension in ELC because of MUT and copied self-schedules**

### Example 10 Manual commitment treated as CAISO commitment

This example illustrates that a CAISO IFM commitment period due to operator manual commitment prior to execution of the MPM is extended to meet MUT in ELC.

Assumptions:

- SUT = 19 hours
- MUT = 36 hours
- MDT = 20 hours
- Operator manually commit the unit in the period of [4/4/07 12:00, 4/4/07 24:00)
- The IFM commits the unit for the period of [4/4/07 12:00, 4/4/07 24:00) and determined that this period is CAISO IFM Commitment
- There is no additional commitment in RUC

- The ELC commits the unit for the periods of {[4/4/07 12:00, 4/5/07 24:00]}

The entire ELC Commitment Period will be CAISO ELC Commitment Period because the period of {[4/4/07 12:00, 4/4/07 24:00]} is extended to {[4/4/07 12:00, 4/5/07 24:00]} because of MUT of 36 hours. This is illustrated in Figure 10.

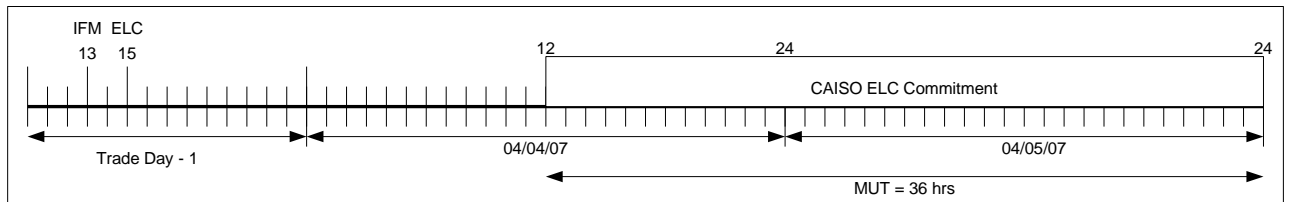

**Figure 10 Manual commitment treated as CAISO commitment**

### D.3.2 Minimum Down Time (MDT) Examples

#### Example 11 - IFM Self-commitment extension in ELC because of MDT

This example illustrates that an IFM Self-commitment period is extended to meet MDT in ELC.

Assumptions:

- SUT = 19 hours
- MUT = 10 hours
- MDT = 20 hours
- Energy Self Schedule submitted for the period of [4/4/07 08:00, 4/4/07 18:00)
- The IFM commits the unit for the period of [4/4/07 08:00, 4/4/07 18:00) and determined that this period is IFM Self-commitment, i.e.,

$$\{\text{SELF}\}_{\text{S-IFM}} = \{\text{UC}\}_{\text{S-IFM}} = [4/4/07 08:00, 4/4/07 18:00)$$

- There is no additional RUC commitment
- The ELC commits the unit for the following periods:

$$\{\text{SELF}\}_{\text{S-ELC}} = \{\text{UC}\}_{\text{S-ELC}} = {[4/4/07 08:00, 4/5/07 18:00]}$$

The entire ELC Commitment Period will be ELC Self-Commitment Period because the energy self-schedule submitted for the period of [4/4/07 08:00, 4/4/07 18:00) is also used as energy self-schedule for the period of [4/5/07 08:00, 4/5/07 18:00), and the period of {[4/4/07 18:00, 4/5/07 08:00]} is less than the MDT of 20 hours. This is illustrated in Figure 11.

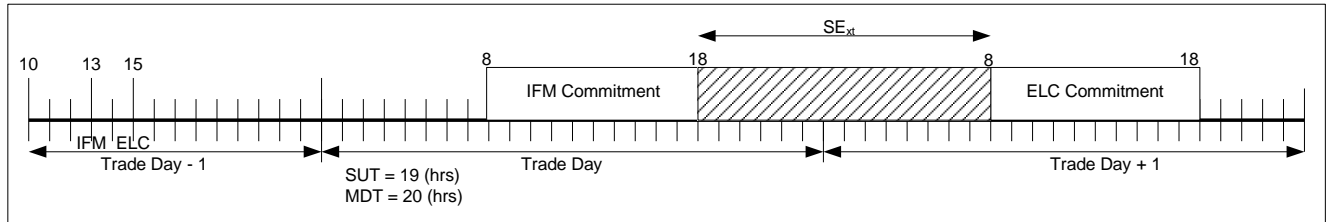

**Figure 11 IFM Self-commitment extension in ELC because of MDT**

### Example 12 Self-Commitment Extension in ELC due to combination of MUT and MDT

This example illustrates Self-Commitment Extension in ELC due to combination of MUT and MDT.

Assumptions:

- SUT = 19 hours
- MUT = 5 hours
- MDT = 20 hours
- Energy self-schedule submitted for the periods of [4/4/07 0:00, 4/4/07 2:00) and [4/4/07 22:00, 4/4/07 24:00), which is accepted by SIBR because of existence of commitment period at the end of 4/3/07.
- The IFM commits the unit for the period of [4/4/07 0:00, 4/4/07 2:00) and [4/4/07 22:00, 4/4/07 24:00) and determined that these periods are IFM Self-commitment
- There is no additional commitment in RUC
- The ELC commits the unit for the periods of {[4/4/07 0:00, 4/4/07 2:00) , [4/4/07 22:00, 4/5/07 24:00)}. Note, the energy self-schedules submitted for IFM of 4/4/07 are also used for ELC of 4/5/07.

All ELC Commitment Periods will be ELC Self-commitment Periods because the periods of {[4/4/07 0:00, 4/4/07 2:00), [4/4/07 22:00, 4/5/07 2:00), and [4/5/07 22:00, 4/5/07 24:00) are covered by energy self-schedules; and the period [4/4/07 22:00, 4/5/07 2:00) is extended to [4/4/07 22:00, 4/5/07 3:00) because of MUT of 5 hours; and then the periods of [4/4/07 22:00, 4/5/07 3:00) and [4/5/07 22:00, 4/5/07 24:00) are merged due to the MDT of 20 hours. This is illustrated in Figure 12.

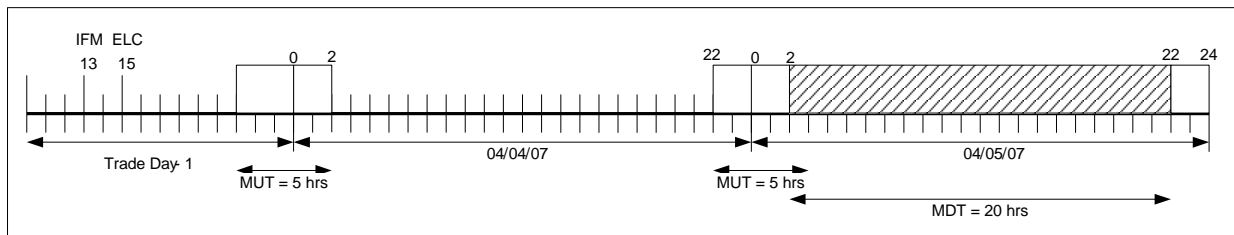

**Figure 12 Self-Commitment Extension in ELC due to combination of MUT and MDT.**

**Example 13 – CAISO IFM Commitment extends Self-commitment extension in ELC**

This example illustrates the situation where the CAISO IFM/RUC commitments following a self-schedule commitment period extends the ELC Self-commitment periods due to MDT in ELC.

Assumptions:

- SUT = 19 hours
- MUT = 10 hours
- MDT = 20 hours
- Energy Self Schedule submitted for the period of [4/4/07 08:00, 4/4/07 18:00)
- The IFM commits the unit for the period of [4/4/07 08:00, 4/4/07 18:00) and determined that this period is IFM Self-commitment, i.e.,

$$\{\text{SELF}\}_{\text{S-IFM}} = \{\text{UC}\}_{\text{S-IFM}} = [4/4/07 \text{ 08:00}, 4/4/07 \text{ 18:00})$$

- The RUC commits the unit for the period of [4/4/07 08:00, 4/4/07 24:00) and determined the following RUC Commitment periods:

$$\{\text{UC}\}_{\text{S-RUC}} = [4/4/07 \text{ 08:00}, 4/4/07 \text{ 24:00})$$

$$\{\text{SELF}\}_{\text{S-RUC}} = \{\text{SELF}\}_{\text{S-IFM}} = [4/4/07 \text{ 08:00}, 4/4/07 \text{ 18:00})$$

$$\{\text{CAISO}\}_{\text{S-RUC}} = [4/4/07 \text{ 18:00}, 4/4/07 \text{ 24:00})$$

Then we have:

- The ELC commits the unit for the following periods:

$$\{\text{UC}\}_{\text{S-ELC}} = \{[4/4/07 \text{ 08:00}, 4/5/07 \text{ 18:00})\}$$

$$\{\text{SELF}\}_{\text{S-ELC}} = \{[4/4/07 \text{ 08:00}, 4/4/07 \text{ 18:00}), [4/5/07 \text{ 00:00}, 4/5/07 \text{ 18:00})\}$$

$$\{\text{CAISO}\}_{\text{S-ELC}} = \{[4/4/07 \text{ 18:00}, 4/4/07 \text{ 24:00})\}$$



The entire ELC Commitment Period would have been ELC Self-commitment Period if there were no additional RUC commitment during the period of [4/4/07 18:00, 4/4/07 24:00) due to MDT of 20 hours. However, the 24-hour time horizon RUC does not see far enough to know that the period of [4/4/07 18:00, 4/4/07 24:00) should be considered RUC Self-commitment period due to MDT. If a 48-hour time horizon RUC is used, the period of [4/4/07 18:00, 4/4/07 24:00) should be considered RUC Self-commitment period and consequently ELC Self-commitment period. However, the outcome of the first day for ELC is not important because ELC commitments are only used for the second day. This is illustrated in Figure 13.

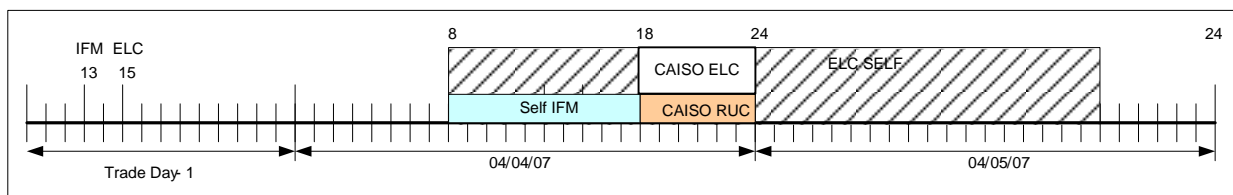

**Figure 13 CAISO IFM Commitment extends Self-commitment extension in ELC**

#### **Example 14 IFM/RUC automatic commitment treated as CAISO commitment in subsequent ELC**

This example illustrates that a CAISO IFM commitment period due to SCUC optimization is extended to meet MUT in the subsequent ELC.

Assumptions:

- SUT = 19 hours
- MUT = 36 hours
- MDT = 20 hours
- Energy bids are submitted for every hours of 4/4/07 on 4/3/07; no self-schedules or self-provisions are submitted
- The IFM executed on 4/3/07 commits the unit in the period of [4/4/07 08:00, 4/4/07 24:00) and determined that the entire period is CAISO IFM commitment

Then,

- The ELC executed on 4/3/07 commits the unit for the period of [4/4/07 08:00, 4/5/07 20:00) to satisfy MUT of 36 hours and determined that this period is CAISO ELC Commitment. This is illustrated in Figure 14.

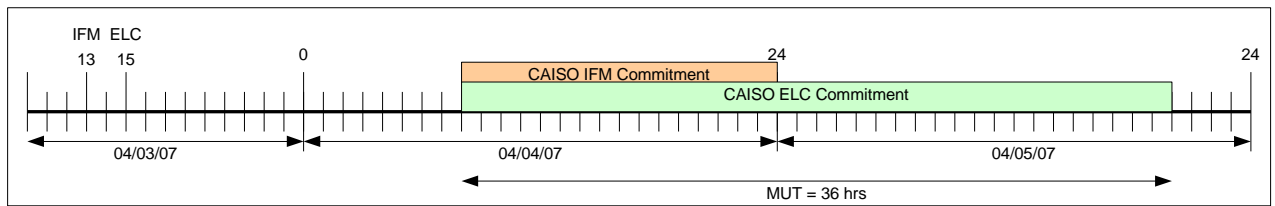

**Figure 14 IFM/RUC automatic commitment treated as CAISO commitment in subsequent ELC**

## D.4 CAISO/Self-Commitment Extension in IFM - Examples

### D.4.1 Minimum Up-Time (MUT) Examples

SIBR ensures that MUT are satisfied for the energy self-schedules except for the self-schedules at the end of the day. The following examples illustrate this situation.

#### **Example 15 IFM Self-Commitment Period at the End of the Day**

A unit is 'ON' from 19:00 to 24:00. It has DAM self-schedules for 3 hours from 21:00 to 24:00. Its MUT is 5 hours. The submitted self-schedule is less than the MUT of the resource and this is accepted by SIBR because the set of consecutive self-schedules are at the end of the day. Self-commitment Period is [21, 24). Self-Commitment Period is **not** extended to [19:00, 24:00) because the IFM commits the unit in [19:00, 21:00) for economic reasons and not for MUT. Therefore, [19, 21) is considered as CAISO commitment and not an extension of self-commitment. This is illustrated in Figure 15.

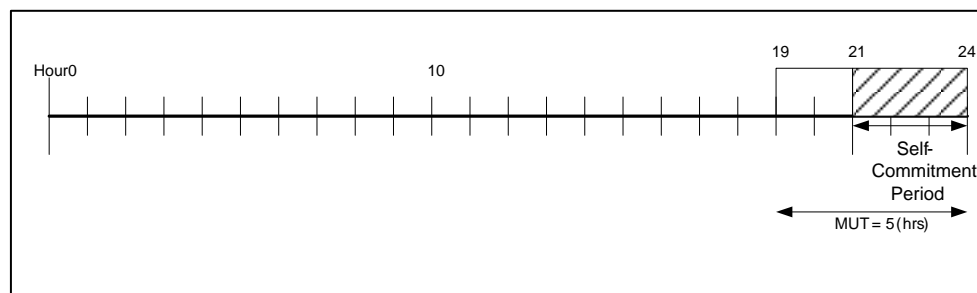

**Figure 15 IFM Self-Commitment Period at the end of the day**

#### **Example 16 CAISO Commitment continuation of Self-Commitment Period from Previous Day**

Continue from the previous example; the unit had energy self-schedules in [21, 24) of the previous day. The unit is 'ON' from 0:00 to 4:00 in the current trading day. It does not have any self-schedule from 0:00 to 4:00 in the current trading day. Its MUT is 5 hours. Since the MUT has already been satisfied in the previous day, the commitments in [0, 4) of the current day is CAISO-Commitment. This is illustrated in Figure 16.

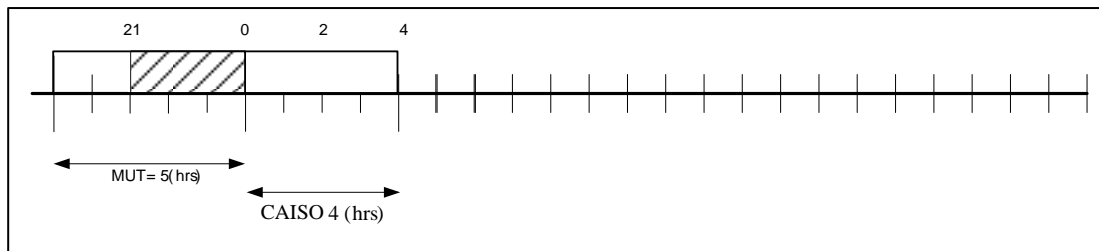

**Figure 16 CAISO Commitment continuation of Self-Commitment Period from Previous Day**

**Example 17 IFM Self-Commitment Period at the End of the Day not satisfying MUT**

A unit is 'ON' from 21:00 to 24:00. It has DAM self-schedules for 3 hours from 21:00 to 24:00. Its MUT is 5 hours. The submitted self-schedule is less than the MUT of the resource and this is accepted by SIBR because the set of consecutive self-schedules are at the end of the day. Self-commitment Period is [21, 24). This is illustrated in Figure 17.

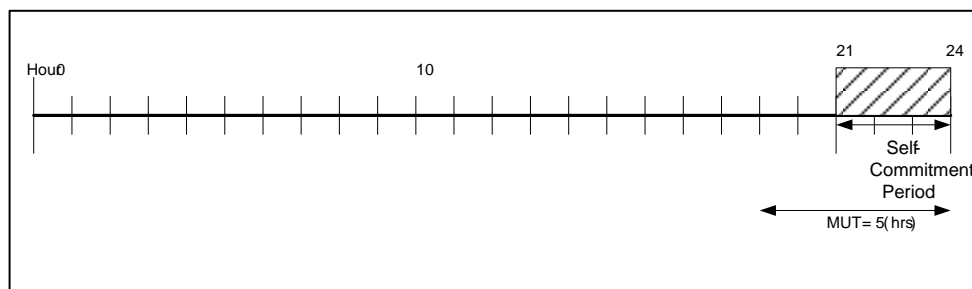
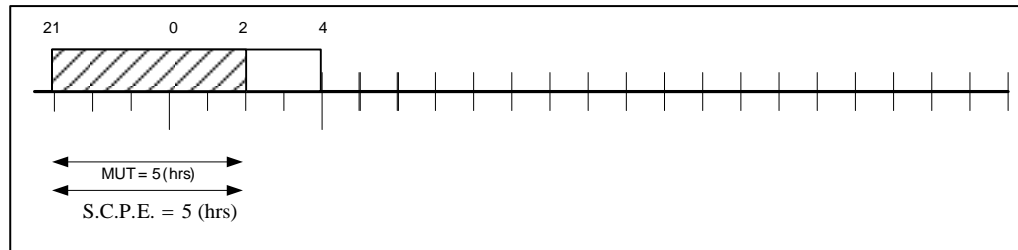

**Figure 17 IFM Self-Commitment Period at the end of the day not satisfying MUT**

**Example 18 Self-Commitment continuation of Self-Commitment Period from Previous Day**

Continue from the previous example; the unit had energy self-schedules in [21:00, 24:00) of the previous day. The unit is 'ON' from 0:00 to 4:00 in the current trading day. It

does not have any self-schedule from 0:00 to 4:00 in the current trading day. Since its MUT of 5 hours has not been satisfied, the Self-Commitment Period of the previous day will be extended into the current day to meet the MUT; resulting in [0:00, 2:00) as Self-Commitment Period. But there is no need to report the portion of the Self-Commitment Period in the previous trade day, i.e., [21:00, 24:00) of the previous trading day. The commitment period of [3:00, 4:00) is CAISO Commitment. This is illustrated in Figure 18.



**Figure 18 Self-Commitment continuation of Self-Commitment Period from Previous Day**

#### **Example 19 IFM/RUC automatic commitment treated as CAISO commitment in next IFM**

This example illustrates that a CAISO IFM commitment period due to SCUC optimization is extended to meet MUT in the next IFM.

Assumptions:

- SUT = 10 hours
- MUT = 36 hours
- MDT = 12 hours
- Low energy bids are submitted for every hours of 4/4/07 on 4/3/07; no self-schedules or self-provisions are submitted
- High energy bids are submitted for every hours of 4/5/07 on 4/4/07; no self-schedules or self-provisions are submitted
- The IFM executed on 4/3/07 commits the unit in the period of [4/4/07 00:00, 4/4/07 24:00) and determined that the entire period is CAISO IFM commitment.
- There are no additional ELC commitments for 4/5/07.

Then,

- The IFM executed on 4/4/07 commits the unit for the period of [4/5/07 00:00, 4/5/07 12:00) to satisfy MUT of 36 hours and determined that this period is CAISO IFM Commitment. This is illustrated in Figure 19.

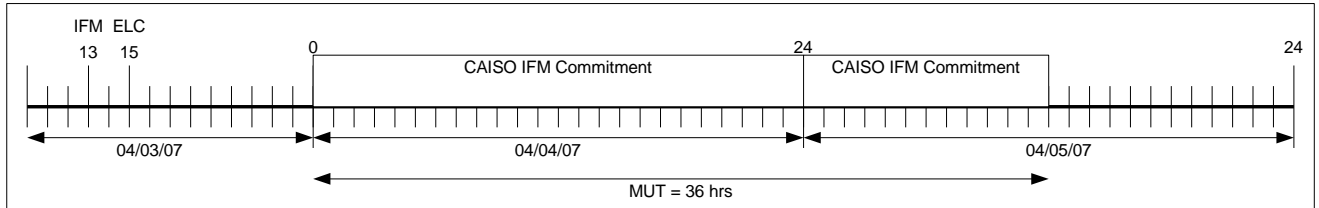

**Figure 19 IFM/RUC automatic commitment treated as CAISO commitment in next IFM**

## D.5 Pump Storage Resources and Participating Loads

A pump-storage unit has three operating modes: generating mode, pumping mode and offline mode. The multi-state model for a pump storage unit is shown below. According to the current implementation, a transition from the pumping mode to the generating mode must go through the offline mode; and a transition from the generating mode to the pumping mode must also go through the offline mode. The Minimum Down-Time (MDT), specified in minutes, is the minimum time the pump-storage unit must stay offline before transitioning into either the pumping mode or the generating mode. The same MDT is used for both the pumping mode and the generation mode.

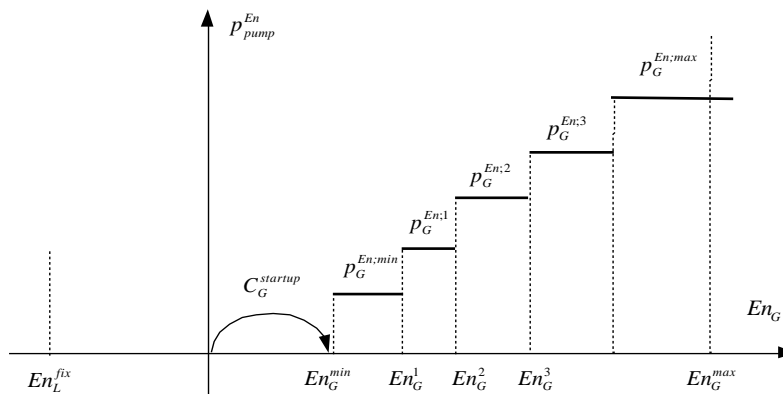

---

### **Multi-State Model for Pumped Storage Unit**

A pump-storage unit has separate Minimum Up Time (MUT) for pumping and generating mode. A pump-storage unit has separate Maximum Daily Startup number for pumping and generating mode.

The commitment types of a pump storage unit operating in generating mode are determined in the same way that the commitment types of other generators are determined as illustrated in Section D.3.

A pump storage unit is considered self-committed in pumping mode in an hour in a market if there is an energy self-schedule in the pumping mode in the market. The self-commitment period extensions for a pump storage unit in pumping mode follow the same rules and examples as specified so far except that separate MUT and MDS are used for operating in pumping mode.

A Participating Load is a Load with a Participating Load Agreement (PLA) and is certified for demand response and may be able to provide Non-Spinning Reserve.

In MRTU software Release 1, a Participating Load (PL) will be modeled by a pair of fictitious Non-Participating Load and fictitious Generator. The PL inter-temporal constraints are converted outside of Siemens application for the fictitious Generator as follows:

- Load Curtailment Time => Generator Startup Time,
- Minimum Load Reduction Time => Generator Minimum Up Time,
- Minimum Base Load Time => Generator Minimum Down Time (set to zero), and
- Maximum Number of Daily Load Curtailments => maximum number of daily generator startups.

Note all these load inter-temporal parameters are constant values not dependent on time load being curtailed.

The commitment types of the fictitious generators are determined in the same way as other generators as illustrated so far.

## D.6 Real-time Self Commitment Type determination

### D.6.1 Introduction

While the self-commitment types of ELC, IFM and RUC commitment are determined by the market applications, the real-time self-commitment types are determined on an after-the-fact base since this determination requires a full history of the DA and real-time commitment status. The following table lists the market processes and their expected behavior:

Table D.1 Market Processes and their expected behavior

Day	Time	Activity
D-2	13:00-15:00	ELC executes and passes the commitment types of extremely long start resources to the next IFM
D-1	10:00-13:00	IFM executes and determines the IFM commitment types (including the ELC commitment results)
D-1	10:00-13:00	RUC executes and determines the RUC commitment types (including the ELC and IFM commitment results)
D-1	13:00	Final IFM and RUC commitment types available to RTUCs; i.e., {UC} <sub>S-IFM</sub> , {SELF} <sub>S-IFM</sub> , {UC} <sub>S-RUC</sub>
D-1	20:07:30	The STUC executed at this time has the first hour of day D in the time horizon; STUC with operator approval can make binding unit commitment decisions for the 15-minute intervals in the period of [00:00, 01:00) in Day D. STUC will make the binding commitment type {UC} <sub>S-STUC</sub> available to subsequent RTUC, RTD and MQS. If there is any energy self-schedule or AS self-provision in hour [21:00, 22:00) of day D-1, the commitment by STUC for hour [00:00, 01:00) of day D is based on copied self-schedule. However, the commitment type

		will be determined later by MQS using the bid actually submitted for [00:00, 01:00) of day D.
D-1	22:52:30	The HASP executed at this time has the first hour of day D in the time horizon using the bid submitted for this hour. HASP with operator approval can make binding unit commitment decisions for the 15-minute intervals in the period of [00:00, 01:00) in Day D. HASP will make the binding commitment type {UC} <sub>S-HASP</sub> available to subsequent RTUC, RTD and MQS.
D-1 to D	any time	OOS instructions can override the commitment status made by the SCUC processes. All OOS instructions (Startup, Shut Down, Min, Max and Fix) can alter the commitment status determined by SCUC including those pre-specified by the operator prior to SCUC execution. Such OOS instructions should be reflected in the RTUC commitment type {UC} <sub>S-RTUC</sub> . In other words, the time intervals in which the unit is off by OOS should not be included in the {UC} <sub>S-RTUC</sub> and the time intervals in which the unit is On by OOS should be included in the {UC} <sub>S-RTUC</sub> . The OOS instructions are provided to MQS to allow MQS to determine the commitment types for intervals in {UC} <sub>S-RTUC</sub> . If an OOS instruction occurs in the middle of a 15 minute interval, it will affect the commitment status and type for the entire 15-minutes interval in the {UC} <sub>S-RTUC</sub> .
D	23:22:30	The RTUC3 executed at this time is the last process that has the last 15-minute interval in day D in the time horizon. RTUC3 makes binding unit commitment decisions for the last 15-minute interval in Day D. RTUC3 shall make the binding commitment decision {UC} <sub>S-RTUC3</sub> available to subsequent RTUC, RTD and



		MQS.
D	23:37:30	The RTUC4 executed at this time is the first process that has the first 15-minute interval in day D+1 as binding commitment interval. RTUC4 shall make the binding commitment decision $\{UC\}_{S-RTUC4}$ for day D+1 available to subsequent RTUC, RTD and MQS.
D	After 24:00	All commitment decisions for day D are final and available for MQS to determine the RTM commitment types.

Table D.2 Input Data Needed to determine Commitment Types

Data	Source	Description
$\{UC\}_{S-IFM}$	IFM	For each resource in each IFM time horizon, the IFM Commitment Periods denoted by the set $\{UC\}_{S-IFM}$ consists of all the hours in which the resource is “On” as determined by the IFM SCUC including the previous binding ELC Commitment decisions passed to the current DAM, and those operator pre-specified commitment decision made at the beginning of the MPM process prior to the current IFM execution.
$\{SELF\}_{S-IFM}$	IFM	The IFM Self-commitment Periods denoted by the set $\{SELF\}_{S-IFM}$ consists of all the previous ELC Self-commitment Periods and the self-commitment periods determined by the current DAM energy Self-Schedules and AS Self-Provisions. Note, the operator pre-specified commitment decisions made at the beginning

		of the DAM process prior to MPM/RRD execution shall <b>not</b> be considered as “Self-Commitment” even though such manual commitments may be treated by the SCUC in a similar way as energy self-schedules. If the CAISO decides to commit a resource using the software automatically or manually, the commitment should be considered as CAISO commitment.
{UC} S-RUC	RUC	For each resource in each RUC time horizon, the RUC Commitment Periods denoted by the set {UC} S-RUC consists of all the hours in which the resource is “On” as determined by the RUC SCUC including the IFM Commitment decisions passed to the RUC.
{UC} S-RTUC	RTUC	The RTUC application includes HASP, STUC, RTUC3 and RTUC4. {UC} S-RTUC includes all intervals of “On” status that are binding as determined by previous processes (IFM, RUC, ELC, RTUC, OOS) and the current process.
DA Energy Self-Schedules	SIBR	The energy self-schedules must be the originally submitted energy self-schedules.
DA AS Self-provisions (including LFD and LFU)	IFM	The AS self-provisions must be the originally submitted AS self-provisions.
RT Energy Self-Schedules	SIBR	The energy self-schedules must be the originally submitted energy self-schedules.
RT Base Schedules	SIBR	The base schedules must be the originally

		submitted base schedules.
RT AS Self-provisions (including LFD and LFU)	SIBR	The AS self-provisions must be the originally submitted AS self-provisions.
RT RMR Requirement	RT MPM	This is the result of RT MPM process.
MUT	Master File	Minimum Up Time (for pump storage resource, separate values in pumping and generating modes)
MDT	Master File	Minimum Down Time
MDS	Master file	Maximum Number of Daily Startup (for pump storage resource, separate values in pumping and generating modes)
Fast Start	Master File	Fast Start indicates that the unit can deliver energy within 10 minutes from off-line status.
On Time	RTM application	On Time is the period between the beginning of the interval when the unit was turned “On” and the end of the last contiguous “On” interval before the unit is turned “Off”. In other words, On Time is measured <b>at a given time</b> by the minutes elapsed since the resource was most recently started up at the Minimum Load and continuously stayed online.

### **D.6.2 RTM Self-Commitment Type Determination for Generator Resources**

The definitions and rules in this subsection apply to generator resources, inter-tie generator resources, and pump-storage generator resources operating in generating mode.

**Def 1 A Real-Time Market (RTM) Commitment Period is a set of consecutive intervals of “On” status generated by the RTUCs and STUC, including the**

---

**commitment decisions made by ELC, IFM and RUC and not altered by the RTUCs, for a resource in a given time period.**

**Def 2 The length of a RTM Commitment Period is measured by the difference between the start-time and the end-time.**

**Def 3 A Super RTM Commitment Period is the longest RTM Commitment Period among the RTM Commitment Periods that have nonempty intersection for the resource in the given period.<sup>3</sup>**

**Def 4 A Sub RTM Commitment Period is a RTM Commitment Period that is shorter than at least one RTM Commitment Period that has nonempty intersection with it for the resource in the given period.**

**Def 5 A Super RUC Commitment Period is the longest RUC Commitment Period among the RUC Commitment Periods that have nonempty intersection for the resource in a given period.**

**Def 6 A Super IFM Commitment Period is the longest IFM Commitment Period among the IFM Commitment Periods that have nonempty intersection for the resource in a given period.**

**Def 7 A RTM Self-Commitment Period is a RTM Commitment Period that is resulted from energy self-schedules, AS self-provisions and their interaction with inter-temporal constraints imposed by MUT, MDT and MDS for the resource in the given period.**

**Def 8 A Basic RTM Self-Commitment Period is a RTM Self-Commitment Period that is resulted directly from energy self-schedules, and AS self-provisions without considering their interaction with inter-temporal constraints imposed by MUT, MDT and MDS for the resource in the given period.**

**Def 9 A MUT Extended RTM Self-Commitment Period is a RTM Self-Commitment Period that is resulted from one or more Basic RTM Self-Commitment Periods and their interaction with inter-temporal constraints imposed by MUT for the resource in the given period. The MUT used here is rounded up to the next 15-minute commitment interval if it is not already in multiples of 15-minutes. A Basic RTM Self-Commitment Period is referred to as a MUT Extended RTM Self-Commitment Period after the MUT Extension process even if no MUT extension is made.**

**Def 10 A MDT Extended RTM Self-Commitment Period is a RTM Self-Commitment Period that is resulted from one or more MUT Extended RTM Self-Commitment Period and their interaction with inter-temporal constraints imposed by MDT for the resource in the given period. The MDT used here is rounded up to the next 15-minute commitment interval if it is not already in multiples of 15-minutes. A MUT Extended RTM Self-Commitment Period is referred to as a MDT Extended RTM Self-Commitment Period after the MDT Extension process even if no MDT extension is made.**

---

<sup>3</sup> The given period is not limited within the Trading Day; the given period will be specified in the context of the rules. A Super RTM Commitment Period loosely speaking is a longest continuous RTM Commitment Period which contains many Sub RTM Commitment Periods.

**Def 11 A MDS Extended RTM Self-Commitment Period is a RTM Self-Commitment Period that is resulted from one or more MDT Extended RTM Self-Commitment Period and their interaction with inter-temporal constraints imposed by MDS for the resource in the given period. A MDT Extended RTM Self-Commitment Period is referred to as a MDS Extended RTM Self-Commitment Period after the MDS Extension process even if no MDS extension is made.**

**Def 12 A BCR RTM Self-Commitment Period is a RTM Self-Commitment Period that is resulted from a MDS Extended RTM Self-Commitment Period by excluding its intersections with IFM Commitment Periods and RUC Commitment Periods for the resource in a given period. A MDS Extended RTM Self-Commitment Period is referred to as a BCR Extended RTM Self-Commitment Period after the BCR Exclusion process even if no truncation is made to exclude the intersection with any IFM Commitment Period or RUC Commitment Period.**

**Def 13 The BCR RTM Self-Commitment Periods, denoted by {SELF} RTM, shall be the union of all BCR RTM Self-Commitment Commitment Periods, for a resource in a given time period.**

**Def 14 The BCR RTM Commitment Periods, denoted by {UC}RTM, shall be the union of all RTM Commitment Periods excluding their intersections with IFM Commitment Periods and RUC Commitment Periods for the resource in the given period.**

**Def 15 The BCR CAISO RTM Commitment Periods, denoted by {CAISO}RTM, shall be the union of all BCR RTM Commitment Periods excluding their intersections with the BCR RTM Self-Commitment Periods, for a resource in a given time period.**

**Def 16 The RMR RTM Commitment Periods, denoted by {RMR} RTM, shall be the union of all the time intervals where an RMR resource has any positive (i.e., non-zero) DAM RMR Requirements or positive RTM RMR Requirements.**

**Def 17 The RTM MUT Backtrack Window, is a period that has a configurable length and ends at the beginning of the current Trading Day. The configurable length is 10080 minutes (i.e., 7 days) by default.**

**Def 18 The RTM MDT Backtrack Window, is a period that has a configurable length and ends at the end of the current Trading Day. By default the configurable length is 4320 minutes (i.e., 3 days).**

**Def 19 The RTM MDT Forthcoming Window, is a period that has a configurable length and starts at the end of the current Trading Day. By default the configurable length is 1440 minutes (i.e., 1 day).**

A RTM Self-Commitment Period will go through the following stages in arriving at the final usable form for Bid Cost Recovery (BCR).

Basic → MUT Extension → MDT Extension → MDS Extension → BCR Exclusion

---

The Basic RTM Self-Commitment Periods for a resource in a given period are constructed as follows:

- Rule 1. If the resource is not a fast start unit, identify all the hours in which the resource has any of the following in the trading day: RTM energy self-schedule, RTMLFU, RTM LFD, RTM Regulation Up self-provision, RTM Regulation Down self-provision, Spinning Reserve self-provision or Non-Spinning Reserve self-provision in the given period.
- Rule 2. If the resource is a fast start unit, identify all the hours in which the resource has any of the following in the trading day: RTM energy self-schedule, RTMLFU, RTM LFD, RTM Regulation Up self-provision, RTM Regulation Down self-provision, or Spinning Reserve self-provision in the given period.
- Rule 3. Each set of consecutive hours identified in Rule 1 or Rule 2, is a Basic RTM Self-Commitment Period.

The MUT Extended RTM Self-Commitment Periods for a resource in the current Trading Day are constructed in sequence as follows:

- Rule 4. If a Basic RTM Self-Commitment Period [h, e) is a Sub RTM Commitment Period<sup>4</sup>, and if the length of the Basic RTM Self-Commitment Period is less than the current MUT of the resource minus the “On Time” evaluated at the beginning of the Basic RTM Self-Commitment Period, i.e., if  $(e - h) < \text{MUT} - \text{On\_Time}$ , the Basic RTM Self-Commitment Period must be extended to the minimum of  $h + \text{MUT} - \text{On\_Time}$ , the end of the Super RTM Commitment Period that has intersection with the Basic RTM Self-Commitment Period that is being extended, or the end of the current Trading Day.<sup>5</sup>  
(Note, this step shall address several special cases:

---

<sup>4</sup> Only a Sub RTM Commitment Period can be extended within the Super RTM Commitment Period that contains it. A Super RTM Commitment Period within a given period cannot be extended within the given period because a Super RTM Commitment Period represents the entire number of intervals having “On” status in the given period.

<sup>5</sup> The “On-Time” evaluated at the beginning of the Basic RTM Self-Commitment Period represents how long the unit has been in “On” status continuously until the beginning of the Basic RTM Self-Commitment Period. The Basic RTM Self-Commitment Period only needs to be extended to cover the remaining of the MUT counted from the beginning of the Basic RTM Self-Commitment Period.

- 
- i. If a Basic RTM Self-Commitment Period [h, e) in a Trading Day is a Sub RTM Commitment Period that starts at the beginning of the day, and the resource was “On” at the end of the previous Trading Day, and if the length of the Basic RTM Self-Commitment Period is less than the MUT of the resource minus the “On Time” evaluated at the end of the previous Trading Day, i.e., if  $(e-h) < \text{MUT} - \text{On\_Time}$ , the Basic RTM Self-Commitment Period must be extended to the minimum of  $h + \text{MUT} - \text{On\_Time}$ , the end of the Super RTM Commitment Period that has intersection with the Basic RTM Self-Commitment Period that is being extended, or the end of the current Trading Day.<sup>6</sup>
  - ii. If a Basic RTM Self-Commitment Period [h, e) in a Trading Day is a Sub RTM Commitment Period that starts at the beginning of the day, and the resource was “Off” at the end of the previous Trading Day, and if the length of the Basic RTM Self-Commitment Period is less than the MUT of the resource, i.e., if  $(e-h) < \text{MUT}$ , the Basic RTM Self-Commitment Period must be extended to the minimum of  $h + \text{MUT}$ , the end of the Super RTM Commitment Period that has intersection with the Basic RTM Self-Commitment Period that is being extended, or the end of the current Trading Day.
  - iii. If a Basic RTM Self-Commitment Period [h, e) in a Trading Day is a Sub RTM Commitment Period that does not start at the beginning of the day, and if the length of the Basic RTM Self-Commitment Period is less than the MUT of the resource minus the “On Time” evaluated at the beginning of the Basic RTM Self-Commitment Period, i.e., if  $(e-h) < \text{MUT} - \text{On\_Time}$ , the Basic RTM Self-Commitment Period must be extended to the minimum of  $h + \text{MUT} - \text{On\_Time}$ , the end of the Super RTM Commitment Period that has intersection with the Basic RTM Self-Commitment Period that is being extended, or the end of the current Trading Day.

---

<sup>6</sup> The “On\_Time” of the previous days are counted towards meeting the MUT of the Basic RTM Self-Commitment.

---

iv. If a Basic RTM Self-Commitment Period [h, e) in a Trading Day is not a Sub RTM Commitment Period, (in other words, if it is a Super RTM Commitment Period), even if the length of the Basic RTM Self-Commitment Period is less than the MUT of the resource minus the “On Time” evaluated at the beginning of the Basic RTM Self-Commitment Period, i.e., if  $(e-h) < \text{MUT} - \text{On\_Time}$ , the Basic RTM Self-Commitment Period will not be extended because the resource will be off beyond the end of the Basic RTM Self-Commitment Period.)

Rule 5. If in the RTM MUT Backtrack Window there is a Super RTM Commitment Period [s, o) that intersects with a MDS Extended RTM Self-Commitment Period [m, o) that ends at the end of the previous Trading Day, if the length of the Super RTM Commitment Period in the RTM MUT Backtrack Window is X minutes less than the current MUT of the resource minus the On Time evaluated at the beginning of the Super RTM Commitment Period in the RTM MUT Backtrack Window, and if there is a Super RTM Commitment Period [o, e) that is in the current Trading Day and starts at the beginning of the current Trading Day, a MUT Extended Commitment Period [o,  $\min(X, e)$ ) shall be defined with the start-time being the beginning of the current Trading Day and the end-time being the smaller of X minutes after the beginning of the current Trading Day and the end of the Super RTM Commitment Period that is in the current Trading Day and starts at the beginning of the current Trading Day.

Rule 6. After this MUT extension process, the Basic RTM Self-Commitment Periods are referred to as MUT Extended RTM Self-Commitment Periods regardless of whether any extension was made.

Rule 7. If the MUT Extended RTM Self-Commitment Periods generated by the MUT extension process as described by Rule 4 through Rule 6 have nonempty intersections, the MUT Extended RTM Self-Commitment Periods having nonempty intersections should be merged.



---

The MDT Extended RTM Self-Commitment Periods for a resource in a Trading Day are constructed in sequence as follows:

- Rule 8. If two disjoint and nonadjacent MUT Extended RTM Self-Commitment Periods intersect with the same Super RTM Commitment Period<sup>7</sup> in the current Trading Day, and if the two MUT Extended RTM Self-Commitment Periods are apart from each other by less than the current MDT of the resource, the two MUT Extended RTM Self-Commitment Periods should be merged to form a MDT Extended RTM Self-Commitment Period.
- Rule 9. If a MUT Extended RTM Self-Commitment Period or a MDT Extended RTM Self-Commitment Period resulted from Rule 8 in the current Trading Day intersects the same Super RTM Commitment Period with a disjoint, nonadjacent and earlier Super RUC Commitment Period in the RTM MDT Backtrack Window, and if the MUT/MDT Extended RTM Self-Commitment Period is apart from the Super RUC Commitment Period by less than the current MDT of the resource, the start-time of the MUT/MDT Extended RTM Self-Commitment Period resulted from Rule 8 should be extended to the later of the end-time of the Super RUC Commitment Period or the beginning of the current Trading Day.
- Rule 10. If a MUT Extended RTM Self-Commitment Period or a MDT Extended RTM Self-Commitment Period resulted from Rule 8 and Rule 9 in the current Trading Day intersects the same Super RTM Commitment Period with a disjoint, nonadjacent and earlier MDS Extended RTM Self-Commitment Period in the RTM MDT Backtrack Window, and if the MUT/MDT Extended RTM Self-Commitment Period is apart from the MDS Extended RTM Self-Commitment Period by less than the current MDT of the resource, the start-time of the MUT/MDT Extended RTM Self-Commitment Period should be extended to the later of the end-time of the

---

<sup>7</sup> Since the Super RTM Commitment Period contains both MUT Extended RTM Self-Commitment Periods, the unit is “On” during the gap between the two MUT Extended RTM Self-Commitment Periods. If two MUT Extended RTM Self-Commitment Periods do not intersect with a common Super RTM Commitment Period, the unit must have “Off” status during the gap between the two MUT Extended RTM Self-Commitment Periods.

---

MDS Extended RTM Self-Commitment Period or the beginning of the current Trading Day.

- Rule 11. If a MUT Extended RTM Self-Commitment Period or a MDT Extended RTM Self-Commitment Period resulted from Rule 8 through Rule 10 in the current Trading Day, intersects the same Super RTM Self-Commitment Period with a disjoint, nonadjacent and later Super RUC Commitment Period in the current Trading Day, and if the MUT/MDT Extended RTM Self-Commitment Period is apart from the Super RUC Commitment Period by less than the current MDT of the resource, the end-time of the MUT/MDT Extended RTM Self-Commitment Period should be extended to the start-time of the Super RUC Commitment Period.
- Rule 12. If a MUT Extended RTM Self-Commitment Period or a MDT Extended RTM Self-Commitment Period resulted from Rule 8 through Rule 11 intersects with a Super RTM Self-Commitment Period that ends at the end of the current Trading Day, and if the MUT/MDT Extended RTM Self-Commitment Period is apart from a disjoint, nonadjacent and later Super RUC Commitment Period in the RTM MDT Forthcoming Window by less than the current MDT of the resource, the end-time of the MUT/MDT Extended RTM Self-Commitment Period should be extended to the end of the current Trading Day.
- Rule 13. After this MDT extension process, the MUT Extended RTM Self-Commitment Periods are referred to as MDT Extended RTM Self-Commitment Periods regardless of whether any extension was made.
- Rule 14. If the MDT Extended RTM Self-Commitment Periods generated by the MDT extension process as described by Rule 8 through Rule 13 have nonempty intersections, the MDT Extended RTM Self-Commitment Periods having nonempty intersections should be merged.

The MDS Extended RTM Self-Commitment Periods for a resource in a Trading Day are constructed in sequence as follows:

- 
- Rule 15. If there is any RTM Self-Commitment Period that starts at the beginning of the Trading Day, or any RUC Commitment Period that starts at the beginning of the Trading Day, and the resource was “On” at the end of the previous Trading Day, and if the total number of MDT Extended RTM Self-Commitment Periods and their disjoint and nonadjacent Super RUC Commitment Periods in the Trading Day is greater than  $(MDS+1)$  of the resource, the MDT Extended RTM Self-Commitment Periods must be extended in both directions in time iteratively to fill first the smallest time gap with other disjoint and nonadjacent MDT Extended RTM Self-Commitment Periods or Super RUC Commitment Periods that intersects the same Super RTM Commitment Period until the number of MDT Extended RTM Self-Commitment Periods and their disjoint and nonadjacent Super RUC Commitment Periods in the Trading Day is equal to  $(MDS+1)$ .
- Rule 16. If there is no RTM Commitment Period that starts at the beginning of the Trading Day and there is no RUC Commitment Period that starts at the beginning of the Trading Day, or the resource was “Off” at the end of the previous Trading Day, and if the total number of MDT Extended RTM Self-Commitment Periods and their disjoint and nonadjacent Super RUC Commitment Periods in the Trading Day is greater than the MDS of the resource, the MDT Extended RTM Self-Commitment Periods must be extended in both directions in time to fill first the smallest gap in time with the other disjoint and nonadjacent MDT Extended RTM Self-Commitment Periods or Super RUC Commitment Periods that intersects the same Super RTM Commitment Period until the number of MDT Extended RTM Self-Commitment Periods and their disjoint and nonadjacent Super RUC Commitment Periods in the Trading Day is equal to MDS.
- Rule 17. After this MDS extension process, the MDT Extended RTM Self-Commitment Periods are referred to as MDS Extended RTM Self-Commitment Periods regardless of whether any extension was made.

---

The BCR RTM Self-Commitment Periods for a resource in a Trading Day are constructed as follows:

- Rule 18. If an MDS Extended RTM Self-Commitment Period intersects with a Super RUC Commitment Period, the intersection is excluded from the MDS Extended RTM Self-Commitment Period; and the remaining portion of the MDS Extended RTM Self-Commitment Period is the BCR RTM Self-Commitment Period.

### **D.6.3. RTM Commitment Type Determination for Pump Storage Generator Resources in Pumping Mode**

The general definitions (Def 1-4, and Def 6) in the previous section for generators also apply to the pumping mode. The definitions and rules in this subsection apply to pump-storage generator resources operating in pumping mode.

**Def 20 A RTM Self-Commitment Period in pumping mode is a RTM Commitment Period that is resulted from energy self-schedules in pumping mode and their interaction with inter-temporal constraints imposed by MUT, MDT and MDS (in pumping mode) for the resource in the given period.<sup>8</sup>**

**Def 21 A Basic RTM Self-Commitment Period is a RTM Self-Commitment Period that is resulted directly from energy self-schedules in pumping mode (which is represented by negative quantities) without considering their interaction with inter-temporal constraints imposed by MUT, MDT and MDS (in pumping mode) for the resource in the given period.**

**Def 22 A MUT Extended RTM Self-Commitment Period in pumping mode is a RTM Self-Commitment Period in pumping mode that is resulted from one or more Basic RTM Self-Commitment Periods in pumping mode and their interaction with inter-temporal constraints imposed by MUT in pumping mode for the resource in the given period. The MUT used here is rounded up to the next 15-minute commitment interval if it is not already in multiples of 15-minutes. A Basic RTM Self-Commitment Period in pumping mode is referred to as a MUT Extended RTM Self-Commitment Period in pumping mode after the MUT Extension process even if no MUT extension is made.**

**Def 23 A MDT Extended RTM Self-Commitment Period in pumping mode is a RTM Self-Commitment Period in pumping mode that is resulted from one or more MUT Extended RTM Self-Commitment Period in pumping mode and their interaction with inter-temporal constraints imposed by MDT for the resource in the given**

---

<sup>8</sup> A pump-storage resource has separate MUT and MDS for operating in generating mode and pumping mode. A pump-storage resource has a single MDT for transitioning from generating mode to generating mode, from generating mode to pumping mode, from pumping mode to generating mode and from pumping mode to pumping mode.

period. The MDT used here is rounded up to the next 15-minute commitment interval if it is not already in multiples of 15-minutes. A MUT Extended RTM Self-Commitment Period in pumping mode is referred to as a MDT Extended RTM Self-Commitment Period in pumping mode after the MDT Extension process even if no MDT extension is made.

**Def 24 A MDS Extended RTM Self-Commitment Period in pumping mode is a RTM Self-Commitment Period in pumping mode that is resulted from one or more MDT Extended RTM Self-Commitment Period in pumping mode and their interaction with inter-temporal constraints imposed by MDS for the resource in pumping mode in the given period. A MDT Extended RTM Self-Commitment Period in pumping mode is referred to as a MDS Extended RTM Self-Commitment Period in pumping mode after the MDS Extension process even if no MDS extension is made.**

**Def 25 A BCR RTM Self-Commitment Period in pumping mode is a RTM Self-Commitment Period in pumping mode, which is resulted from a MDS Extended RTM Self-Commitment Period in pumping mode by excluding its intersections with IFM Commitment Periods in pumping mode for the resource in a given period. A MDS Extended RTM Self-Commitment Period in pumping mode is referred to as a BCR Extended RTM Self-Commitment Period in pumping mode after the BCR Exclusion process even if no truncation is made to exclude the intersection with any IFM Commitment Period in pumping mode.**

**Def 26 The BCR RTM Self-Commitment Periods in pumping mode, denoted by {SELFP}RTM, shall be the union of all BCR RTM Self-Commitment Periods in pumping mode, for a resource in a given time period.**

**Def 27 The BCR RTM Commitment Periods in pumping mode, denoted by {UCP}RTM, shall be the union of all RTM Commitment Periods in pumping mode excluding their intersections with IFM Commitment Periods in pumping mode for the resource in the given period.**

**Def 28 The BCR CAISO RTM Commitment Periods in pumping mode, denoted by {CAISOP}RTM, shall be the union of all BCR RTM Commitment Periods in pumping mode excluding their intersections with the BCR RTM Self-Commitment Periods in pumping mode, for a resource in a given time period.**

**Def 29 The RTM MUT Backtrack Window in pumping mode, is a period that has a configurable length and ends at the beginning of the current Trading Day. The configurable length is 2880 minutes (i.e., 2 days) by default. Note a pump-storage generator shall use two separately configurable RTM MUT Backtrack Windows; one for generating mode and the other for pumping mode.**

**Def 30 The RTM MDT Backtrack Window in pumping mode, is a period that has a configurable length and ends at the end of the current Trading Day. By default the configurable length is 2880 minutes (i.e., 2 days). Note a pump-storage generator shall have two separately configurable RTM MDT Backtrack Windows; one for generating mode and the other for pumping mode.**

**Def 31 The RTM MDT Forthcoming Window in pumping mode, is a period that has a configurable length and starts at the end of the current Trading Day. By default the configurable length is 1440 minutes (i.e., 1 day). Note a pump-storage**

---

**generator shall use two separately configurable RTM MDT Forthcoming Windows; one for generating mode and the other for pumping mode.**

A RTM Self-Commitment Period in pumping mode will go through the following stages in arriving at the final usable form for Bid Cost Recovery (BCR).

Basic → MUT Extension → MDT Extension → MDS Extension → BCR Exclusion

The Basic RTM Self-Commitment Periods in pumping mode for a resource in a given period are constructed as follows:

Rule 19. If the resource is a pump-storage generating resource, identify all the hours in which the resource has RTM energy self-schedules in pumping mode in the given period.

Rule 20. Each set of consecutive hours identified in Rule 19, is a Basic RTM Self-Commitment Period in pumping mode.

The MUT Extended RTM Self-Commitment Periods in pumping mode for a resource in a given period are constructed using Rule 4 through Rule 7 except now the commitment periods are in pumping mode and the RTM MUT Backtrack Window is in pumping mode as defined by Def 29.

The MDT Extended RTM Self-Commitment Periods in pumping mode for a resource in a Trading Day are constructed as follows:

Rule 21. If two disjoint and nonadjacent MUT Extended RTM Self-Commitment Periods in pumping mode intersect with the same Super RTM Commitment Period in pumping mode in the current Trading Day, and if the two MUT Extended RTM Self-Commitment Periods in pumping mode are apart from each other by less than the relevant MDT of the resource, the two MUT Extended RTM Self-Commitment Periods in pumping mode should be merged to form a MDT Extended RTM Self-Commitment Period in pumping mode.

- 
- Rule 22. If a MUT Extended RTM Self-Commitment Period in pumping mode or a MDT Extended RTM Self-Commitment Period in pumping mode resulted from Rule 21 intersects the same Super RTM Commitment Period in pumping mode with a disjoint, nonadjacent and earlier Super IFM Commitment Period in pumping mode in the RTM MDT Backtrack Window in pumping mode, and if the MUT/MDT Extended RTM Self-Commitment Period in pumping mode is apart from the Super IFM Commitment Period by less than the current MDT of the resource, the start-time of the MUT/MDT Extended RTM Self-Commitment Period in pumping mode should be extended to the end-time of the Super IFM Commitment Period in pumping mode or the beginning of the current Trading Day.
- Rule 23. If a MUT Extended RTM Self-Commitment Period in pumping mode or a MDT Extended RTM Self-Commitment Period in pumping mode resulted from Rule 21 and Rule 22 in the current Trading Day intersects the same Super RTM Commitment Period in pumping mode with a disjoint, nonadjacent and earlier MDS Extended RTM Self-Commitment Period in pumping mode in the RTM MDT Backtrack Window in pumping mode, and if the MUT/MDT Extended RTM Self-Commitment Period in pumping mode is apart from the MDS Extended RTM Self-Commitment Period in pumping mode by less than the current MDT of the resource, the start-time of the MUT/MDT Extended RTM Self-Commitment Period in pumping mode should be extended to the later of the end-time of the MDS Extended RTM Self-Commitment Period in pumping mode or the beginning of the current Trading Day.
- Rule 24. If a MUT Extended RTM Self-Commitment Period in pumping mode or a MDT Extended RTM Self-Commitment Period in pumping mode resulted from Rule 21 through Rule 23 in the current Trading Day, intersects the same Super RTM Self-Commitment Period in pumping mode with a disjoint, nonadjacent and later Super IFM Commitment Period in pumping mode in the current Trading Day, and if the MUT/MDT Extended RTM Self-Commitment Period in pumping mode is apart from the Super IFM

---

Commitment Period in pumping mode by less than the current MDT of the resource, the end-time of the MUT/MDT Extended RTM Self-Commitment Period in pumping mode should be extended to the start-time of the Super IFM Commitment Period in pumping mode.

Rule 25. If a MUT Extended RTM Self-Commitment Period in pumping mode or a MDT Extended RTM Self-Commitment Period in pumping mode resulted from Rule 21 through Rule 24 in the current Trading Day, intersects with a Super RTM Self-Commitment Period in pumping mode, which ends at the end of the current Trading Day, and if the MUT/MDT Extended RTM Self-Commitment Period in pumping mode is apart from a disjoint, nonadjacent and later Super IFM Commitment Period in pumping mode in the RTM MDT Forthcoming Window in pumping mode, by less than the current MDT of the resource, the end-time of the MUT/MDT Extended RTM Self-Commitment Period in pumping mode should be extended to the end of the current Trading Day.

Rule 26. After this MDT extension process, the Basic RTM Self-Commitment Periods in pumping mode are referred to as MDT Extended RTM Self-Commitment Periods in pumping mode regardless of whether any extension was made.

Rule 27. If the MDT Extended RTM Self-Commitment Periods in pumping mode generated by the MDT extension process as described by Rule 21 through Rule 26 have nonempty intersections, the MDT Extended RTM Self-Commitment Periods having nonempty intersections should be merged.

The MDS Extended RTM Self-Commitment Periods in pumping mode for a resource in a Trading Day are constructed as follows:

Rule 28. If there is any RTM Self-Commitment Period in pumping mode that starts at the beginning of the Trading Day, or any IFM Commitment Period in pumping mode that starts at the beginning of the Trading Day; and the resource was “On” in pumping mode at the end of the previous Trading



---

Day, and if the total number of MDT Extended RTM Self-Commitment Periods in pumping mode and their disjoint and nonadjacent Super IFM Commitment Periods in pumping mode in the Trading Day is greater than  $(MDS+1)$  of the resource, the MDT Extended RTM Self-Commitment Periods in pumping mode must be extended in both directions in time iteratively to fill first the smallest time gap with other disjoint and nonadjacent MDT Extended RTM Self-Commitment Periods in pumping mode or Super IFM Commitment Periods in pumping mode that intersects the same Super RTM Commitment Period in pumping mode until the number of MDT Extended RTM Self-Commitment Periods in pumping mode and their disjoint and nonadjacent Super IFM Commitment Periods in pumping mode in the Trading Day is equal to  $(MDS+1)$ ;

Rule 29. If there is no RTM Commitment Period in pumping mode that starts at the beginning of the Trading Day and there is no IFM Commitment Period in pumping mode that starts at the beginning of the Trading Day, or the resource was not in pumping mode at the end of the previous Trading Day, and if the total number of MDT Extended RTM Self-Commitment Periods in pumping mode and their disjoint and nonadjacent Super IFM Commitment Periods in pumping mode in the Trading Day is greater than the relevant (i.e., pump) MDS of the resource, the MDT Extended RTM Self-Commitment Periods in pumping mode must be extended in both directions in time to fill first the smallest gap in time with the other disjoint and nonadjacent MDT Extended RTM Self-Commitment Periods in pumping mode or Super IFM Commitment Periods in pumping mode that intersects the same Super RTM Commitment Period in pumping mode until the number of MDT Extended RTM Self-Commitment Periods in pumping mode and their disjoint and nonadjacent Super IFM Commitment Periods in pumping mode in the Trading Day is equal to relevant (i.e., pump) MDS.

Rule 30. After this MDS extension process for pump storage generating resources in pumping mode, the MDT Extended RTM Self-Commitment Periods in pumping mode are referred to as MDS Extended RTM Self-Commitment

---

Periods in pumping mode regardless of whether any extension was made.

The BCR RTM Self-Commitment Periods in pumping mode for a resource in a Trading Day are constructed as follows:

- Rule 31. If a MDS Extended RTM Commitment Period in pumping mode intersects with a Super IFM Commitment Period in pumping mode, the intersection is excluded from the MDS Extended RTM Commitment Period in pumping mode; the remaining portion of the MDS Extended RTM Commitment Period in pumping mode is the BCR RTM Self-Commitment Period in pumping mode.

The BCR for Pump Shut-Down Cost will not be based on the BCR RTM Self-Commitment Periods because the BCR RTM Self-Commitment Periods indicate that the unit is in pumping mode because of self-schedules. For determination of the eligibility for BCR of Pump Shut-Down Cost, one needs to determine whether the unit is transitioning out of the pumping mode solely because of the unit's own decision and not CAISO's decision. Therefore, whether a RTM pump shut-down, is considered as "self commitment", is determined according to the following rules.

- Rule 32. If the RTM Commitment Periods in pumping mode in a Trading Day indicates a Pump Shutdown (i.e., end of a Super RTM Commitment Period in pumping mode), and the unit does not have any Pump Cost Bid Component or Pumping Self-Schedule Bid Component for the immediate hour after the RTM Pump Shutdown, the RTM Pump Shutdown is BCR RTM Self-Commitment.

- Rule 33. If the RTM Commitment Periods in pumping mode in a Trading Day indicates a Pump Shutdown (i.e., end of a Super RTM Commitment Period in pumping mode), and the unit has a Basic RTM Self-Commitment Period in generating mode starting within the relevant MDT after the RTM Pump Shutdown, the RTM Pump Shutdown is BCR RTM Self-Commitment.

## D.6.4. Examples for RTM Commitment Type Determination

### Example 20 – Generator Resource RTM Commitment type determination Rule # 4 (i) MUT

In this example, the following assumptions are made as shown in Figure .

- MUT = 6 hours
- There resource was “On” in the period [23, 24) of the previous Trading Day
- Basic RTM Self-Commitment Period: [0, 4) in the current Trading Day.
- Super RTM Commitment Period: [0, 8) in the Current Trading Day.

According to Rule #4(i), since the length of the Basic RTM Self-Commitment Period (4 hours) is less than the MUT of the resource minus the ‘On time” (5 hours), the Self-Commitment period must be extended to the minimum of 5 hours. This extension process results in the MUT Extended RTM Self-Commitment Period [0, 5). This is illustrated in Figure 20.

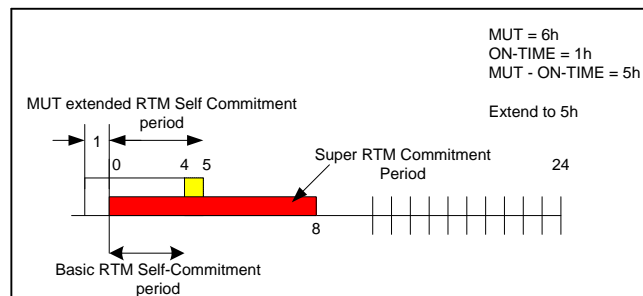

**Figure 20: Illustration of Rule #4(i)**

### Example 21 – Generator Resource RTM Commitment type determination Rule # 4 (ii) MUT

In this example, the following assumptions are made as shown in Figure 21.

- MUT = 6 hours
- The resource was OFF at the end of the previous Trading Day

- Basic RTM Self-Commitment Period: [0, 4) in the current Trading Day.
- Super RTM Commitment Period: [0, 10) in the Current Trading Day.

According to Rule #4(ii), since the length of the Basic RTM Self-Commitment Period (4 hours) is less than the MUT of the resource (6 hours), the Self-Commitment period must be extended by 2 hours to the minimum of 6 hours. This extension process results in the MUT Extended RTM Self-Commitment Period [0, 6). This is illustrated in Figure 21.

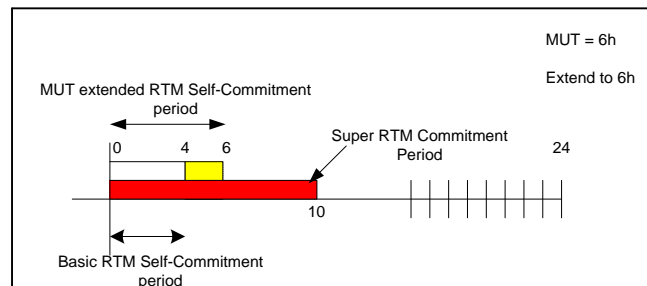

**Figure 21: Illustration of Rule #4(ii)**

### **Example 22 – Generator Resource RTM Commitment type determination Rule # 4 (iii) MUT**

In this example, the following assumptions are made as shown in Figure 2.

- MUT = 8 hours
- Basic RTM Self-Commitment Period: [3, 7) in the current Trading Day.
- On Time evaluated at the beginning of the Basic RTM Self-Commitment Period is 2 hours.
- Super RTM Commitment Period: [1, 11) in the Current Trading Day.

According to Rule #4(iii), since the length of the Basic RTM Self-Commitment Period (4 hours) is less than the MUT of the resource minus the “On Time” evaluated at the beginning of the Basic RTM Self-Commitment Period (6 hours), the Self-Commitment period must be extended by 2 hours to the minimum of 6 hours. This extension process results in the MUT Extended RTM Self-Commitment Period [3, 9). This is illustrated in Figure 22.

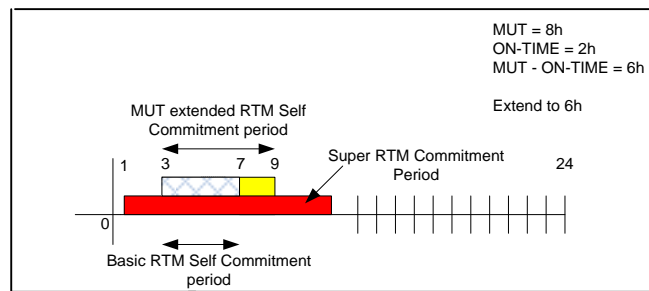

**Figure 22: Illustration of Rule #4(iii)**

**Example 23 – Generator Resource RTM Commitment type determination Rule # 4 (iv) MUT**

In this example, the following assumptions are made as shown in Figure .

- MUT = 8 hours
- Basic RTM Commitment Period: [7, 14) which is also a Super RTM Commitment Period in the current Trading Day.
- On Time evaluated at the beginning of the Basic RTM Commitment Period is zero.

According to Rule #4(iv), even though the length of the commitment period is less than the MUT of the resource minus the “On time”, the Basic RTM Self-Commitment Period is not extended, which results in a MUT Extended RTM Self-Commitment Period [7, 14) even though no extension was made. The reason that no extension is made is because the Basic RTM Commitment Period itself is a Super RTM Commitment Period; the MUT was not observed either because the market participants bids were infeasible as to MUT or the RTM application failed to comply with the MUT. The MQS as a post process cannot extend the Basic Self-Commitment Period into intervals where the unit is “Off.” This is illustrated in Figure 23.

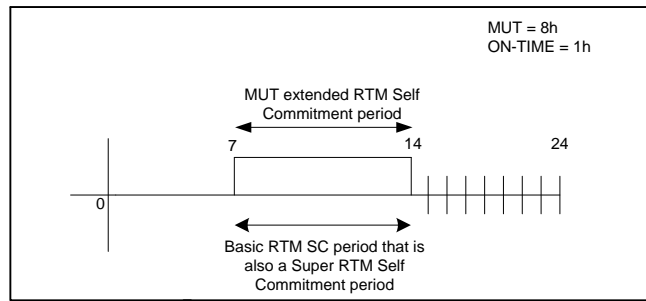

**Figure 23: Illustration of Rule #4(iv)**

**Example 24 – Generator Resource RTM Commitment type determination Rule 5 MUT**

In this example, the following assumptions are made as shown in Figure .

- MUT = 12 hours
- On-time by 6/11/07 18:00 is 240 minutes (i.e., 4 hours)
- Super RTM Commitment Period [6/11/07 18:00, 6/11/07 24:00) in the RTM MUT Backtrack Window
- MDS Extended Self-Commitment Period [6/11/07 21:00, 6/11/07 24:00)
- Super RTM Commitment Period [00:00, 06:00) in the Current Trading Day (6/12/07)

According to Rule 5, since the length of the Super RTM Commitment period in the Backtrack Window, which is 6 hours, is less than the (MUT - On-time) by X = 120 minutes or 2 hours, a MUT Extended Commitment period [00:00, 02:00) is defined in the current Trading Day. The MUT Extended Commitment period [00:00, 02:00) is a portion of the MUT Extended RTM Self-Commitment period [6/11/07 21:00, 6/12/07 02:00) that fits in the current Trading Day. This is illustrated in Figure 24.

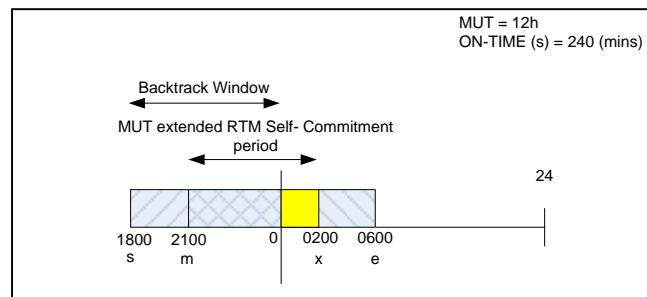

**Figure 24: Illustration of Rule 5**

### Example 25 – Generator Resource RTM Commitment type determination Rule 8 MDT

In this example, the following assumptions are made as shown in Figure .

- MDT = 9 hours
- Super RTM Commitment Period: [0, 24) in the current Trading Day.
- Disjoint and nonadjacent MUT Extended RTM Self-Commitment Periods : [0, 9) and [14, 23)

According to Rule 8, since the two MUT Extended RTM Self-Commitment Periods are apart from each other by less than the MDT of the resource, the two MUT extended RTM Self-Commitment Periods are merged to form a MDT Extended RTM Self-Commitment Period [0, 23). This is illustrated in Figure 25.

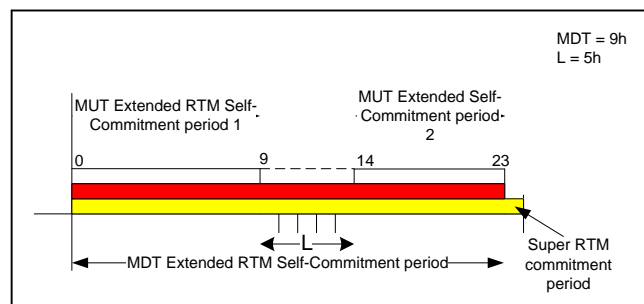

**Figure 25: Illustration of Rule 8**

### Example 26– Generator Resource RTM Commitment type determination Rule 9 MDT

In this example, the following assumptions are made as shown in Figure .

- MDT = 9 hours
- MUT Extended RTM Self-Commitment Period: [05:00, 12:00) in the current Trading Day (6/12/07).

- Super RUC Commitment Period: [6/11/07 14:00, 6/11/07 21:00) in the RTM MDT Backtrack Window
- Super RTM Commitment Period: [6/11/07 14:00, 6/12/07 12:00)

According to Rule 9, since the MUT Extended RTM Self-Commitment Period is apart from the disjoint, nonadjacent and earlier Super RUC Commitment Period by less than the MDT of the resource, the start-time of the MUT Extended RTM Self-Commitment Period is extended to the beginning of the Current Trading Day. This extension process results in a MDT Extended RTM Self-Commitment Period [6/12/07 00:00, 6/12/07 12:00). This is illustrated in Figure 26.

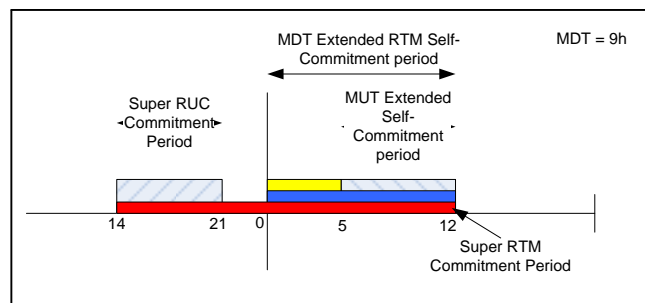

**Figure 26: Illustration of Rule 9**

### **Example 27– Generator Resource RTM Commitment type determination Rule 10 MDT**

In this example, the following assumptions are made as shown in Figure .

- MDT = 9 hours
- MUT Extended RTM Self-Commitment Period: [5, 12) in the current Trading Day (6/12/07).
- A disjoint, nonadjacent and earlier MDS Extended RTM Self-Commitment Period: [6/11/07 14:00, 6/11/07 21:00) in the RTM MDT Backtrack Window
- Super RTM Commitment Period: [6/11/07 15:00, 6/12/07 20:00) which is intersected by both the MUT Extended RTM Self-Commitment period and the MDS Extended RTM Self-Commitment period.



According to Rule 10, since the MUT Extended RTM Self-Commitment Period is apart from the MDS Extended RTM Self-Commitment Period by less than the current MDT of the resource, the start time of the MUT Extended Self-Commitment Period is extended to the beginning of the current trading day. This extension process results in a MDT Extended RTM Self-Commitment Period [6/12/07 00:00, 6/12/07 12:00). This is illustrated in Figure 27.

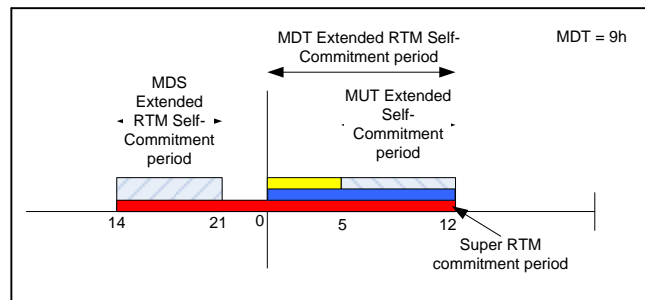

**Figure 27: Illustration of Rule 10.**

### **Example 28– Generator Resource RTM Commitment type determination Rule 11 MDT**

In this example, the following assumptions are made as shown in Figure .

- MDT = 9 hours
- MUT Extended RTM Self-Commitment Period: [4, 12) in the current Trading Day.
- A disjoint, nonadjacent and later Super RUC Commitment Period in the Current Trading Day: [20, 24)
- Super RTM Self-Commitment Period: [4, 24) which is intersected by both the MUT Extended RTM Self-Commitment period and the Super RUC Commitment period detailed previously.

According to Rule 11, since the MUT Extended RTM Self-Commitment Period is apart from the Super RUC Commitment Period by less than the current MDT of the resource, the end time of the MUT Extended Self-Commitment Period is extended to the start-time of the Super RUC Commitment Period. This extension process results in a MDT Extended RTM Self-Commitment Period [4, 20). This is illustrated in Figure 28.

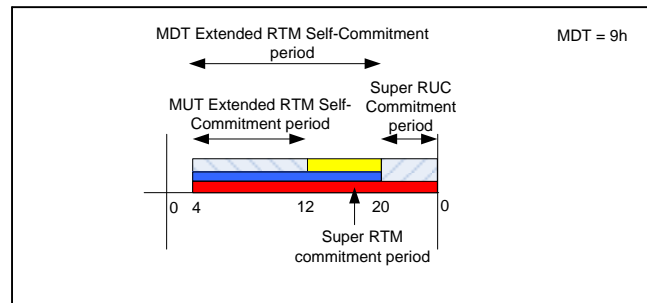

**Figure 28: Illustration of Rule 11**

### Example 29 – Generator Resource RTM Commitment type determination Rule 12 MDT

In this example, the following assumptions are made as shown in Figure

- MDT = 9 hours
- MUT Extended RTM Self-Commitment Period: [6/11/07 06:00, 6/11/07 21:00) in the current Trading Day.
- A disjoint, nonadjacent and later Super RUC Commitment Period in the RTM MDT Forthcoming Window: [6/12/07 02:00, 6/12/07 08:00)
- Super RTM Self-Commitment Period: [6/11/07 06:00, 6/11/07 24:00).

According to Rule 12, since the MUT Extended RTM Self-Commitment Period is apart from the Super RUC Commitment Period by less than the current MDT of the resource, the end time of the MUT Extended Self-Commitment Period is extended to the end of the current Trading Day. This extension process results in a MDT Extended RTM Self-Commitment Period [6/11/07 06:00, 6/11/07 24:00). This is illustrated in Figure 29.

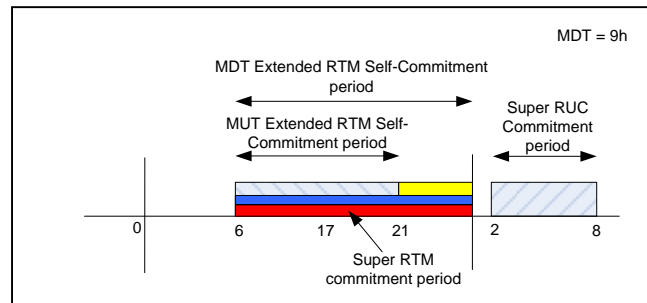

**Figure 29: Illustration of Rule 12**

### Example 30 – Generator Resource RTM Commitment type determination Rule 15 MDS

In this example, the following assumptions are made as shown in Figure

- MDS = 1
- The resource was ON at the end of the previous Trading Day.
- Super RTM Commitment Period: [0, 24) in the current Trading Day.
- Super RUC Commitment Period: [0, 5) in the current Trading Day.
- MDT Extended RTM Self-Commitment Period: [7, 14) in the current Trading Day.
- MDT Extended RTM Self-Commitment Period: [17, 21) in the current Trading Day.

According to Rule 15, since the total number of MDT Extended RTM Self Commitment Periods and their disjoint and nonadjacent Super RUC Commitment Periods in the same trading Day is 3 which is more than  $(MDS + 1) = 2$ , the MDT Extended RTM Self-Commitment Period [7, 14) is extended to fill the smallest time gap [5, 7) with the disjoint and nonadjacent Super RUC Commitment Period [0, 5) that intersect the same Super RTM commitment Period. After this extension process, the number of MDT Extended RTM Self-Commitment Periods or Super RUC Commitment Periods and their disjoint and nonadjacent Super RUC Commitment Periods in the Trading Day is equal to  $(MDS + 1) = 2$ . This extension process results in a MDS Extended Self-Commitment Period [5, 14). This is illustrated in Figure 30.

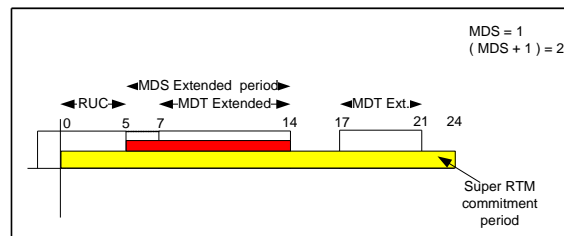

**Figure 30: Illustration of Rule 15.**

### Example 31 – Generator Resource RTM Commitment type determination Rule 16 MDS

In this example, the following assumptions are made as shown in Figure .

- MDS = 2
- The resource was OFF at the end of the previous Trading Day.
- Super RTM Commitment Period: [0, 24) in the current Trading Day.
- Super RUC Commitment Period: [2, 7) in the current Trading Day.
- MDT Extended RTM Self-Commitment Period: [9, 15) in the current Trading Day.
- Super RUC Commitment Period: [18, 21) in the current Trading Day.

According to Rule 16, since the total number of MDT Extended RTM Self Commitment Periods and their disjoint and nonadjacent Super RUC Commitment Periods in the same trading Day is 3 which is more than the MDS (which is 2) of the resource, the MDT Extended RTM Self-Commitment Period is extended to fill the smallest time gap [7, 9) with the disjoint and nonadjacent Super RUC Commitment Period that intersect the same Super RTM commitment Period [2, 7) to bring the number of MDT Extended RTM Self-Commitment Periods and their disjoint and nonadjacent Super RUC Commitment Periods in the Trading Day to MDS (which is 2). This extension process results in a MDS Extended Self-Commitment Period [7, 15). This is illustrated in Figure 31.

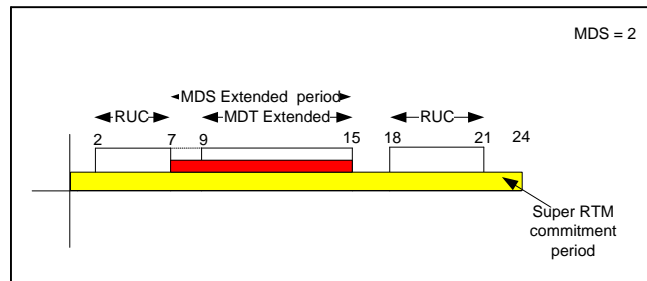

**Figure 31: Illustration of Rule 16.**

### Example 32 – Generator Resource RTM Commitment type determination Rule 18 BCR

In this example, the following assumptions are made as shown in Figure .

- MDS Extended RTM Self-Commitment Period: [0, 15) in the current Trading Day.
- Super RUC Commitment Period: [12, 21) in the current Trading Day.

According to Rule 18, since the MDS Extended RTM Commitment Period intersects with a Super RUC Commitment Period, the intersection is excluded from the MDS Extended RTM Commitment Period and the remaining MDS Extended RTM Commitment Period is the BCR RTM Self-Commitment Period i.e. [0, 12). This is illustrated in Figure 32.

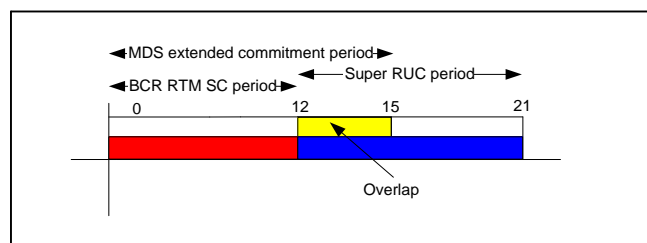

**Figure 32. Illustration of Rule 18.**

### Example 33 - BCR for Pump Shutdown Cost Determination, Rule 32 BCR

In this example, a Super RTM Commitment Period in pumping mode comes to an end and there is no Pump Cost Bid Component or Pump Self-Schedule Bid Component for the immediate hour after the Pump shut-down. Therefore, the Pump shut-down is a BCR RTM Self-Commitment. See Figure 33 for an illustration. This is illustrated in Figure 33.

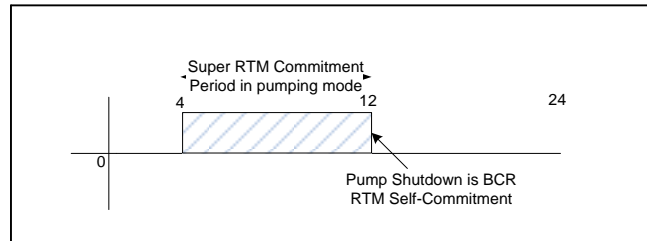

**Figure 33: Illustration of Rule # 32**

### Example 34- BCR for Pump Shutdown Cost Determination, Rule 33 BCR

In this example, a Super RTM Commitment Period in pumping mode comes to an end and the unit has a Basic RTM Self-Commitment Period in generating mode starting within the MDT after the pump shutdown. Therefore, the Pump shut-down is a BCR RTM Self-Commitment. This is illustrated in Figure 34.

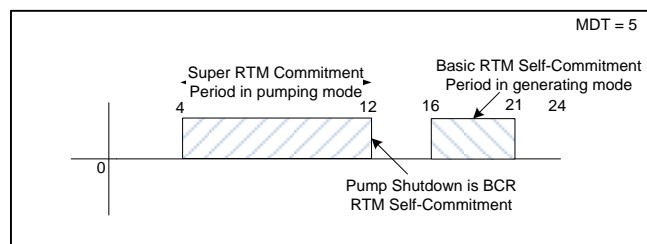

**Figure 34: Illustration for Rule #33**

## D.7. IFM/RUC/RTM Start-up Cost/Pump Shut-down Cost and Minimum Load Cos/Pumping Cost Determination

After the determination of ISO commitment versus self-commitment period, the eligible Start-up Cost (SUC), eligible pump shut-down cost (PSDC), the eligible Minimum Load Cost (MLC) and the eligible Pumping Cost (PC) for each CAISO committed interval in either IFM, RUC, or RTM will need to be calculated. As a by-product, the SUC/PSDC and MLC/PC eligibility flags for IFM, RUC, and RTM. The eligibility flag is a Y/N flag.

---

The determination of commitment cost will include the generating resources including Pumped-Storage Hydro Units as well as the participating loads (pumps that are dispatchable) and tie generators.

### **D.7.1 Data Requirements**

#### Inputs

-- The ISO versus self-commitment periods are determined by business rules described in sections D2 to D6.

#### ISO Commitment Period of IFM, RUC, RTM

Hourly in IFM, RUC, 15 minutes in RTM;

All generators except Pumped-Storage Hydro Units can be committed in on-line or off-line in IFM, RUC, RTM;

All Pumped-Storage Hydro Units can be committed in pumping mode, generation mode or offline mode in IFM, RUC, RTM except there is no pumping mode commitment in RUC;

All Participating Loads can be committed in pumping mode or offline mode in IFM and RTM.

#### Self-Commitment Period of IFM and RTM (no self commit in RUC)

Hourly in IFM, 15 minutes in RTM;

Same rules apply regarding various resources as ISO Commitment except that there is no self-commit in RUC.

#### Start-up Time (All Generators)

#### Minimum Load Cost (All Generators)

Hourly \$ value per resource

#### Startup Cost (All Generators)

\$ value per startup

#### Pumping Cost (Pumped-Storage Hydro Units and Participating Loads)

---

Hourly \$ value per resource

Pump Shut-down cost (Pumped-Storage Hydro Units and Participating Loads)

\$ value per pump shut-down

Real-time Start-up/Shut-down Instructions including exceptional dispatch commitment instructions

RUC Start-up Instructions

### Outputs

BCR Eligible SUC (\$) per resource, per settlement interval, per market type

BCR Eligible MLC (\$) per resource, per settlement interval, per market type

BCR Eligible PSDC (\$) per resource, per settlement interval, per market type

BCR Eligible PC (\$) per resource, per settlement interval, per market type

SUC Eligibility flag per resource, per settlement interval, per market type

PSDC Eligibility flag per resource, per settlement interval, per market type

MLC Eligibility flag per resource, per settlement interval, per market type

PC Eligibility flag per resource, per settlement interval, per market type

## **D.7.2 Some Background Information**

Following description focuses on explanation of the difference between generation and pumping.

### Applicability

A start-up cost/minimum load cost settlement applies to generators and Pumped-Storage Hydro Units in generation mode. Those resources can be committed in IFM, RUC or RTM.



A shutdown cost/pumping cost settlement applies to Pumped-Storage Hydro Units in pumping mode and Participating Load (Pumps). Those resources can be committed in IFM or RTM, not RUC.

### Minimum Load Cost VS Pumping Cost

The concept of pumping cost is the same as minimum load cost except that the resource runs at an energy consumption level. The business rules for determining the eligibility for pumping load cost is the same as for minimum load cost. In the following business rules, we will use the minimum load cost as the term representing both minimum load cost in generation mode and pumping cost in pumping mode.

### Start-Up Cost VS Shut down Cost

A start-up cost settlement applies to generators and Pumped-Storage Hydro Units in generation mode. Those resources can be committed in IFM, RUC or RTM.

A shutdown cost settlement ONLY applies to Pumped-Storage Hydro Units in pumping mode and Participating Load. In the following description, we will simply use the term “Pump” to refer to a participating load (a real pump) or a Pumped-Storage Hydro Unit in pumping mode. Pump shutdown cost is used to recover the cost associated with those resources when they are committed to be shutdown by CAISO while they are in pumping mode.

A shutdown of a pump differs from a startup of a generator in the following perspective:

- 1.A shutdown of Pump happens immediately and hence the “shutdown time period” concept will not be applied;
- 2.The concept of minimum load cost to pump is really the pumping cost as described before;

3. There is no pump shutdown in RUC and hence there is no need to deal with RUC shutdown cost.

A shutdown of a pump is similar to a startup of a generator in the following perspective:

1. A pump is associated with the shutdown cost as part of the bid just like the startup cost. However, a shutdown cost is only one single value while a startup cost is an up to three tiers of step functions based on cooling time;
2. CAISO only pays the pump shutdown due to CAISO commitment reason. CAISO will not pay shutdown cost if the pump is self-committed.

Some clarifications related to Shut-down:

DA Shut-down:

For a pump, when we "turn off" a pump in DA, we do NOT explicitly have a pump Shut-down instruction. The fact that a pumping mode hour followed by an offline mode hour will implicitly tell that the pump was determined to be "shut down" in DA;

For a pumping storage resource, it is similar.

RT Shut-down:

For a pump, when we "turn off" a pump in RT, we do EXPLICITLY have a pump Shut-down instruction;

For a Pumped-Storage Hydro Unit, it is the same except that it is also possible we see a 15-minute in pumping mode followed by a 15-minute interval in generation or off-line mode.

Interim Participating Load modeling in MRTU release 1 :

Since we model some of the pumps using a non-participating load and a pseudo-generating resource in MRTU release 1, for these pumps, the pumping cost will be

---

modeled as the minimum load cost of the pseudo-generator and the pump shutdown cost will be modeled as the startup cost of the pseudo-generator.

Exceptional Dispatch Shut-down:

It is possible to issue an OOS (exceptional dispatch) commitment instruction to Shut-down a pump in RTM.

### **D.7.3 Business Rules for Cost Calculation**

For all start-up and shut-downs, CAISO will check the meter data to determine whether this actually happens before applying appropriate BCR amount. This logic is described in BPM section for settlement. Following rules describe how to calculate the “potential” eligibility and \$ amount for evaluation before comparison of the revenue meter data. For Multi-Stage Generating Resources, the following rules apply at the MSG Configuration level, and do so in conjunction with the Multi-Stage Generating Resource specific rules described in section D7.4.

In following rules, when commitment periods are mentioned, it is always referring to ISO commitment period. A self-commitment period will be specified mentioned as self-commitment period.

#### **Business Rules for IFM Start-Up Cost**

The IFM Start-Up Cost for any IFM Commitment Period shall equal to the Start-Up Costs submitted by the Scheduling Coordinator to the CAISO for the IFM divided by the number of Settlement Intervals in the applicable IFM Commitment Period. For each Settlement Interval, only the IFM Start Cost in a CAISO IFM Commitment Period is eligible for Bid Cost Recovery. The following rules shall apply sequentially to qualify the IFM Start-Up Cost in an IFM Commitment Period:

1. The IFM Start-Up Cost for an IFM Commitment Period shall be zero if it is overlapped with or adjunction to an IFM Self-Commitment Period.

- 
2. The IFM Start-Up Cost for an IFM Commitment Period shall be zero if the Bid Cost Recovery Eligible Resource is manually pre-dispatched under an RMR Contract prior to the Day-Ahead Market or the resource is flagged as an RMR Dispatch in the Day-Ahead Schedule in the Day-Ahead Market anywhere within the applicable IFM Commitment Period.
  3. The IFM Start-Up Cost for an IFM Commitment Period shall be zero if there is no actual Start-Up at the start of the applicable IFM Commitment Period because the IFM Commitment Period is the continuation of an IFM or RUC Commitment Period from the previous Trading Day.
  4. If an IFM Start-Up is terminated in the Real-Time within the applicable IFM Commitment Period through an Exceptional Dispatch Shut-Down Instruction issued while the Bid Cost Recovery Eligible Resource was Starting Up, the IFM Start-Up Cost for that IFM Commitment Period shall be prorated by the ratio of the Start-Up time before termination over the total IFM Start-Up time.
  5. If a Short Start unit is commitment by the IFM and is started up in the Real-time Market after the start of and before the end of the IFM Commitment Period, the IFM Start Up cost shall be qualified. Any subsequent Start-Ups pursuant to a Shut-Down Instruction the Short-Start Unit receives in the Real-Time Market that falls within the IFM Commitment Period, the Start-Up Costs will be qualified as an RTM Start-Up Cost.

#### Business Rules for IFM Minimum Load Cost/Pumping Cost

The Minimum Load Cost for the applicable Settlement Interval shall be the Minimum Load Cost/Pumping Cost submitted to the CAISO in the IFM divided by the number of Settlement Intervals in a Trading Hour. For each Settlement Interval, only the IFM Minimum Load Cost in a CAISO IFM Commitment Period is eligible for Bid Cost Recovery.

The IFM Minimum Load Cost/Pumping Cost for any Settlement Interval is zero if:

1. The Settlement Interval is in an IFM Self Commitment Period for the Bid Cost Recovery Eligible Resource;

---

2. The Bid Cost Recovery Eligible Resource is manually pre-dispatched under an RMR Contract prior to the Day-Ahead Market or the resource is flagged as an RMR Dispatch in the Day-Ahead Schedule for the applicable Settlement Interval;

#### Business Rules for RUC Start-Up Cost

The RUC Start-Up Cost for any Settlement Interval in a RUC Commitment Period shall consist of Start-Up Cost of the Bid Cost Recovery Eligible Resource submitted to the CAISO for the applicable RUC Commitment Period divided by the number of Settlement Intervals in the applicable RUC Commitment Period. For each Settlement Interval, only the RUC Start Cost in a CAISO RUC Commitment Period is eligible for Bid Cost Recovery. The following rules shall be applied in sequence and shall qualify the RUC Start-Up Cost in a RUC Commitment Period:

1. The RUC Start-Up Cost for a RUC Commitment Period is zero if it is overlapped with or adjunction to an IFM Commitment Period within that RUC Commitment Period.
2. The RUC Start-Up Cost for a RUC Commitment Period is zero if the Bid Cost Recovery Eligible Resource is manually pre-dispatched under an RMR Contract prior to the Day-Ahead Market or is flagged as an RMR Dispatch in the Day-Ahead Schedule anywhere within that RUC Commitment Period.
3. The RUC Start-Up Cost for a RUC Commitment Period is zero if there is no RUC Start-Up at the start of that RUC Commitment Period because the RUC Commitment Period is the continuation of an IFM or RUC Commitment Period from the previous Trading Day.
4. If a RUC Start-Up is terminated in the Real-Time within the applicable RUC Commitment Period through an Exceptional Dispatch Shut-Down Instruction issued while the Bid Cost Recovery Eligible Resource is starting up the, RUC Start-Up Cost is prorated by the ratio of the Start-Up Time before termination over the RUC Start-Up Time.

---

5. If a Short Start unit is committed by CAISO in Real Time as a result of its RUC capacity but does not have a Day Ahead Schedule, the commitment type will also be considered a CAISO RUC commitment.

6. If a Short Start unit is commitment by the RUC and is started up in the Real-time Market after the start of and before the end of the RUC Commitment Period, the RUC Start Up cost shall be qualified. Any subsequent Start-Ups pursuant to a Shut-Down Instruction the Short-Start Unit receives in the Real-Time Market that falls within the RUC Commitment Period, the Start-Up Costs will be qualified as an RTM Start-Up Cost.

#### Business Rules for RUC Minimum Load Cost

-- No Pumping Cost will be incurred in RUC

The Minimum Load Cost for the applicable Settlement Interval shall be the Minimum Load Cost of the Generating Bid Cost Recovery Eligible Resource divided by the number of Settlement Intervals in a Trading Hour. For each Settlement Interval, only the RUC Minimum Load Cost in a CAISO RUC Commitment Period is eligible for Bid Cost Recovery. The RUC Minimum Load Cost for any Settlement Interval is zero if:

1. The Bid Cost Recovery Eligible Resource is manually pre-dispatched under an RMR Contract or the resource is flagged as an RMR Dispatch in the Day-Ahead Schedule in that Settlement Interval;
2. The applicable Settlement Interval is included in an IFM Commitment Period.

#### Business Rules for RTM Start-Up Cost

For each Settlement Interval of the applicable Real-Time Market Commitment Period, the Real-Time Market Start-Up Cost shall consist of the Start-Up Cost of the Generating Bid Cost Recovery Eligible Resource submitted to the CAISO for the Real-Time Market divided by the number of Settlement Intervals in the applicable Real-Time Market

---

Commitment Period. For each Settlement Interval, only the Real-Time Market Start-Up Cost in a CAISO Real-Time Market Commitment Period is eligible for Bid Cost Recovery. The following rules shall be applied in sequence and shall qualify the Real-Time Market Start-Up Cost in a Real-Time Market Commitment Period:

1. The Real-Time Market Start-Up Cost is zero if it is overlapped with or adjunction to a Real-Time Market Self-Commitment Period.
2. The Real-Time Market Start-Up Cost is zero if the Bid Cost Recovery Eligible Resource has been manually pre-dispatched under an RMR Contract or the resource is flagged as an RMR Dispatch in the Day-Ahead Schedule or Real-Time Market anywhere within that Real-Time Market Commitment Period.
3. The Real-Time Market Start-Up Cost is zero if there is no Real-Time Market Start-Up at the start of that Real-Time Market Commitment Period because the Real-Time Market Commitment Period is the continuation of an IFM or RUC Commitment Period from the previous Trading Day.
4. If a Real-Time Market Start-Up is terminated in the Real-Time within the applicable Real-Time Market Commitment Period through an Exceptional Dispatch Shut-Down Instruction issued while the Bid Cost Recovery Eligible Resource is starting up the Real-Time Market Start-Up Cost is prorated by the ratio of the Start-Up Time before termination over the Real-Time Market Start-Up Time.

#### Business Rules for RTM Minimum Load Cost/Pumping Cost

The Real-Time Market Minimum Load Cost is the incremental Minimum Load Cost/Pumping Cost of the Bid Cost Recovery Eligible Resource submitted to the CAISO for the Real-Time Market divided by the number of Settlement Intervals in a Trading Hour. The Real-Time Market Minimum Load Cost/Pumping Cost for any Settlement Interval is zero if:

1. The Settlement Interval is included in a Real-Time Market Self Commitment period for Bid Cost Recovery Eligible Resource;

2. The Bid Cost Recovery Eligible Resource has been manually dispatched under an RMR contract or the resource has been flagged as an RMR Dispatch in the Day - Ahead Schedule or the Real-Time Market in that Settlement Interval;
3. That Settlement Interval is included in an IFM or RUC Commitment Period in generation mode for MLC or pumping mode for PC

The Real-Time Market Minimum Load Cost for any Settlement interval is negative if:

1. The Resource is economically de-committed in Real-Time Market for periods the resource has an IFM or RUC Commitment period

#### Business Rules for IFM Shut-down Cost

An IFM Shut-down Period is defined as the hour in which a pump Shut-down is to occur.

The Shut-down is implied and therefore the IFM Shut-down Period will be the immediate hour following the last commitment hour in pumping mode before the “switch”;

The IFM Shut-down Cost for a settlement interval within an IFM Shut-down Period shall equal to the Shut-down Costs submitted by the Scheduling Coordinator to the CAISO for the IFM divided by the number of Settlement Intervals in the IFM Shut-down Period. For each Settlement Interval, only the IFM Shut-down Cost in an IFM Shut-down Period is eligible for Bid Cost Recovery. The following rules shall apply sequentially to qualify the IFM Shut-down Cost in an IFM Shut-down Period:

1. The IFM Shut-down Cost for an IFM Shut-down Period shall be zero if it is followed by an IFM or RT self-commitment period in generation mode or offline mode;
2. The IFM Shut-down Cost for an IFM Shut-down Period shall be zero if it is due to a OMS outage;
3. The IFM Shut-down Cost for an IFM Shut-down Period shall be zero if the Shut-down is delayed by the Real-Time Market past the IFM Shut-down Period in question or cancelled by the Real-Time Market before the shut-down process



---

has started. This can be detected by having the same hour in DA pumping mode and RT Generation/Off-line, Or DA pumping mode followed by Real-time pumping in the following hour.

#### Business Rules for RTM Shut-down Cost

A RTM Shut-down Period is defined as the hour within which a real-time shut down instruction will occur if the shutdown time is within the hour, Or the immediate hour following the instruction if the shutdown time is at an hourly boundary.

The RTM Shut-down Cost for a settlement interval within a RTM Shut-down Period shall equal to the Shut-down Costs submitted by the Scheduling Coordinator to the CAISO for the RTM divided by the number of Settlement Intervals in the RTM Shut-down Period. For each Settlement Interval, only the RTM Shut-down Cost in a RTM Shut-down Period is eligible for Bid Cost Recovery. The following rules shall apply sequentially to qualify the RTM Shut-down Cost in a RTM Shut-down Period:

1. The RTM Shut-down Cost for a RTM Shut-down Period shall be zero if it is followed by a RTM self-commitment period in generation mode or offline mode;

The RTM Shut-down Cost for a RTM Shut-down Period shall be zero if it is due to a OMS outage;

### **D.7.4 Business Rules for Cost Calculation for Multi-Stage Generating Resources**

Both “commitment type” determination and “AUX” process will be executed at the MSG Configuration level for Multi-Stage Generating Resources. Below is an outline of the logic for commitment type determination for resources:

- For MSG Configurations pertaining to CAISO Tariff sections 11.8.1.1, 11.8.1.2, and their commitment types will be determined using the existing logic for non MSG resources described in Section D2, D3, D4 and D6. The application of the

---

business rules is based on each individual MSG Configuration's data with the following specific rules for MSG Generating Resources:

- During a transition from one configuration to another configuration, the transition period is considered as part of the "From" MSG Configuration's Commitment Period.
- For the "To" MSG Configuration, the commitment period does not include the transition period. Instead it starts at the end of the transition period.
- For each MSG Configuration, the self-commitment period extension logic is applicable only when it is active and the resource is online.
- When applying the self commitment period extension rules in D6.2, the Minimum Run Time and Minimum Down Time for the Multi-Stage Generating Resource plant level, individual MSG Configuration level, and the configuration group level will be used.

Pertaining to CAISO Tariff sections 11.8.2.1, 11.8.3.1 and 11.8.4.1, the logic for the BCR consideration and allocation of the Commitment Costs (Start-Up Cost, Minimum Load Cost and Transition Cost) is as follows:

- The logic in determining/distributing the Minimum Load Cost and Start-Up Cost for Multi-Stage Generating Resources is the same as that for non-Multi-Stage Generating Resources except that the Minimum Load Cost and Start-Up Cost will be allocated to the qualified MSG Configuration's CAISO Commitment Period.. The rules for BCR qualifications for the MSG Configuration's CAISO Commitment Period are shown below.
- The Transition Cost will be determined based on whether the "To" MSG Configuration is CAISO committed or not. The Transition Cost amount is the Transition Cost registered for the transition related to the "From" MSG Configuration and "To" MSG Configuration. Transition Cost is allocated to the CAISO Commitment Period of the "To" MSG Configuration. The rules for BCR qualifications for the MSG Configuration's CAISO Commitment Period are shown below.

---

For the MSG Configurations, when starting up from offline to an MSG Configuration, the Start-Up Cost pertaining to that MSG Configuration applies for BCR qualification, and there are no Transition Costs applied.. When transitioning between any two MSG Configurations, since the resources are not offline, the Transition Costs will apply for BCR qualification, whereas Start-Up Costs will not apply. The rules for BCR qualifications for CAISO Commitment Period MSG Configurations (applicable to Start-Up Cost, Minimum Load Cost and Transition Cost), re-stated from the CAISO tariff section 11.8.1.3, are as follows:

For the settlement of the Multi-Stage Generating Resource Start-Up Cost, Minimum Load Cost, and Transition Cost in the IFM, RUC, and RTM, the CAISO will determine the applicable Commitment Period and select the applicable Start-Up Cost, Minimum Load Cost, and Transition Cost based on the following rules.

- (1) In any given Settlement Interval, the CAISO will first apply the following rules to determine the applicable Start-Up Cost and Transition Cost for the Multi-Stage Generating Resources. For a Commitment Period in which:
  - (a) the IFM Commitment Period and/or RUC Commitment Period MSG Configuration(s) are different from the RTM CAISO Commitment Period MSG Configuration, the Multi-Stage Generating Resource's Start-Up Cost and Transition Cost will be settled based on the RTM CAISO Commitment Period MSG Configuration Start-Up Cost, and Transition Cost, as described in Section 11.8.4.1.
  - (b) there is a CAISO IFM Commitment Period and/or CAISO RUC Commitment Period in any MSG Configuration and there is also a RTM Self-Commitment Period in any MSG Configuration, the Multi-Stage Generating Resource's Start-Up Cost and Transition Cost will be settled based on the CAISO IFM Commitment Period and/or CAISO RUC Commitment Period MSG Configuration(s) Start-Up Cost and Transition Cost, as described in Sections 11.8.2.1 and 11.8.3.1, and further determined pursuant to part (2) of this Section below.
  - (c) the CAISO IFM Commitment Period and/or CAISO RUC Commitment Period MSG Configuration is the same as the CAISO RTM Commitment Period

---

MSG Configuration, the Multi-Stage Generating Resource's Start-Up Cost and Transition Cost will be settled based on the CAISO IFM Commitment Period and/or CAISO RUC Commitment Period MSG Configuration(s) Start-Up Cost and Transition Cost described in Sections 11.8.2.1 and 11.8.3.1, and further determined pursuant to part (3) of this Section below.

- (d) the IFM and RUC Self-Commitment Period MSG Configuration(s) are the same as the CAISO RTM Commitment Period MSG Configuration, then the Multi-Stage Generating Resource's Start-Up Cost and Transition Cost will be settled based on the CAISO RTM Commitment Period MSG Configuration Start-Up Cost and Transition Cost as described in Section 11.8.4.1.
- (2) For the purpose of determining which MSG Configuration Minimum Load Costs will apply in any given Commitment Interval, the CAISO will apply the following rules.
- (a) If there is a CAISO IFM Commitment Period and/or CAISO RUC Commitment Period, the CAISO will calculate the IFM Minimum Load Costs and/or RUC Minimum Load Costs, pursuant to Section 11.8.2.1 or 11.8.3.1, respectively, based on the MSG Configuration committed in the IFM or RUC.
  - (b) For purposes of determining the MSG Configuration Minimum Load Costs included in the RTM Minimum Load Cost calculated pursuant to Section 11.8.4.1.2, the CAISO will use the difference between the amounts determined under (i) and (ii) below.
    - (i) The CAISO will calculate the RTM MSG Configuration Minimum Load Costs as the Minimum Load Cost attributed to the MSG Configuration committed in the RTM, whether that MSG Configuration is Self-Scheduled or CAISO-committed.
    - (ii) The CAISO will determine one of the two applicable amounts:
      - a. If there is a Real-Time Market Self-Schedule, the maximum of (A) the Minimum Load Costs attributed to the MSG Configuration either self-Scheduled or CAISO-committed in the IFM or RUC; and (B) the Minimum Load Cost attributed to the MSG Configuration Self-Scheduled in the RTM.

- 
- b. If there is no Real-Time Market Self-Schedule, the Minimum Load Costs attributed to the MSG Configuration either self-Scheduled or CAISO-committed in the IFM or RUC.
- (3) In any given Settlement Interval, after the rules specified in part (1) and (2) above of this Section have been executed, the ISO will apply the following rules to determine whether the IFM or RUC Start-Up Cost, Minimum Load Cost, and Transition Cost apply for Multi-Stage Generating Resources. For a Commitment Period in which:
- (a) the IFM Commitment Period MSG Configuration is different from the CAISO RUC Commitment Period MSG Configuration the Multi-Stage Generating Resource's Start-Up Cost, Minimum Load Cost, and Transition Cost will be settled based on the CAISO RUC Commitment Period MSG Configuration Start-Up Cost, Minimum Load Cost, and Transition Cost as described in Section 11.8.3.1.
- (b) the CAISO IFM Commitment Period MSG Configuration is the same as the CAISO RUC Commitment Period MSG Configuration, the Multi-Stage Generating Resource's Start-Up Cost, Minimum Load Cost, and Transition Cost will be based on the CAISO IFM Commitment Period MSG Configuration Start-Up Cost, Minimum Load Cost, and Transition Cost as described in Section 11.8.2.1.

Note that for (2) (a) above, the RT MLC could be negative when the RT Configuration MLC is less than the DA Configuration MLC.

Note also that, for purposes of Bid Cost Recovery calculations, the total Real-Time Bid allocation for any negative OE type Expected Energy allocated to capacity within the Day-Ahead MSG Configuration will be included as part of the total Real-Time Minimum Load Cost and qualified accordingly. See Appendix Attachment C, section C.7, for more details.

---

## **D.7.5 Business Rules Change for Convergence Bidding**

Bid Cost Recovery costs related to Short Start Units committed by CAISO in the Real-Time as a result of awarded RUC capacity will be included in RUC Compensation Costs. The applicable Trading Hours are those for which the Short Start Units have a non-zero RUC Award but no Day-Ahead Schedule.

# **Attachment E**

## **Price Corrections Make Whole Payments**

---

## E. Price Corrections Make Whole Payments

The following attachment presents further details in support of the CAISO Tariff section *Price Corrections Make Whole Payments, CAISO Demand and Exports*. The following attachment only describes the mechanism to calculate make whole payments for physical demand and exports. Although Virtual Bids are also subject to make whole payment using the same principle as described below, it is performed in a different fashion. Refer to *BPM for Settlement and Billing* for the related charge code changes for Virtual Bid make whole payments.

### E.1 Correction Overview

The “Make Whole” payment mechanism is designed to compensate market participants for adverse financial impacts when prices are corrected in a way that is not consistent with accepted Demand bids. If the LMP Price Correction team corrects an LMP in the upward direction that impacts Demand in the Day-Ahead Market or RTM markets such that the a market participant’s Demand or Export Bid curve becomes uneconomic, then the CAISO will calculate a Make Whole Price Correction. The Make Whole Price Correction will be calculated as follows:

- The total cleared MWhs of CAISO Demand or Export in the Day-Ahead Schedule or FMM Schedule, as applicable, multiplied by the **Derived LMP (or corrected) LMP**, minus the make-whole payment amount, all of which is divided by the total cleared MWhs of CAISO Demand or Export in the Day-Ahead Schedule or FMM Schedule, as applicable.

Specifically, the Make Whole payment amount will be calculated on an hourly basis determined by the area between the resource’s CAISO Demand or Export Bid curve and the **Derived LMP**, which is calculated as the MWhs in each of the cleared bid segments in the Day-Ahead Schedule or FMM Schedule for the affected resource, multiplied by the maximum of zero or the corrected LMP (fifteen-minute LMP in the real-time) minus the bid segment price.

The following summarizes the Make Whole Price Correction:

- Day Ahead price corrections performed by the LMP Price Correction team can render an accepted bid uneconomic.
- Supply resources use the Bid Cost Recovery method to recoup any un-recovered cost



- Make Whole will only apply if:
  - Price increases
  - Only for the portion of bid rendered uneconomic
  - Applies to DA Demand and Exports and RTM Exports

## E.2 Make Whole Calculation Elements

The elements of the Make Whole Price Correction are described in this section.

- **E.2.1 Definition of Bid Portion Rendered Uneconomic**
  - For the portion of Bid that is rendered uneconomic, will be charged the equivalent of “as-bid”, instead of the corrected price. Figures 1 and 2 represent two examples of Make Whole payments as defined by difference levels of price corrections and different levels of where their bid is uneconomic:

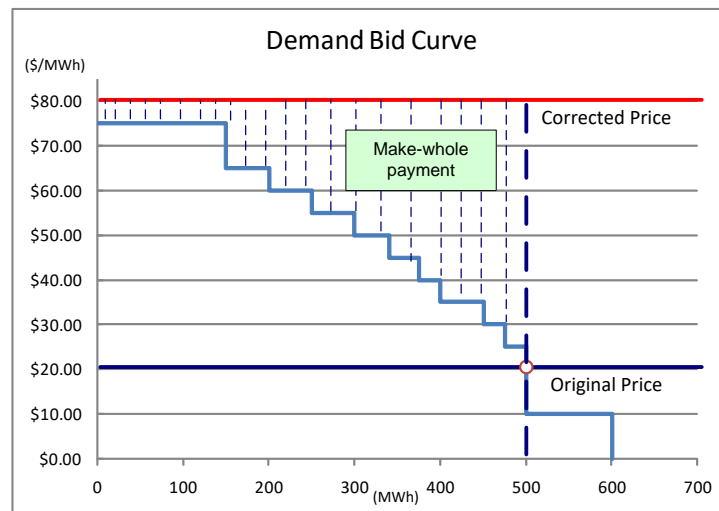

**Figure 6. Price Correction from \$20 to \$80**

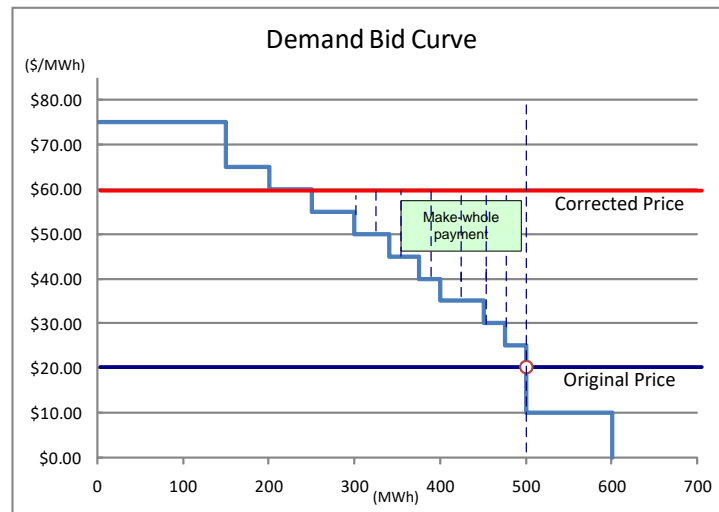

**Figure 7. Price Correction from \$20 to \$60**

### ➤ **E.2.2 Make Whole Price Correction Detailed Examples**

Two examples of the Make Whole Price Correction are described in this section.

In Example 1, suppose the DA price is corrected from \$23 to \$85 and the original bid was accepted for 500MW, and none of which was economic after price correction. The following would occur:

- Demand resource will initially be set at the new LMP;
- The Make Whole Price Correction will calculate how much was “over charged” (striped area in Figure 1) and subtracted from settlement with new LMP;
- A **Derived LMP** will be set reflecting the uneconomic portion;
- The **Derived LMP** will be sent to Settlements in CC 6011 (or 6051) and reflected on the Demand resource’s initial settlement statement.

Figure 3 represents the elements in this example:

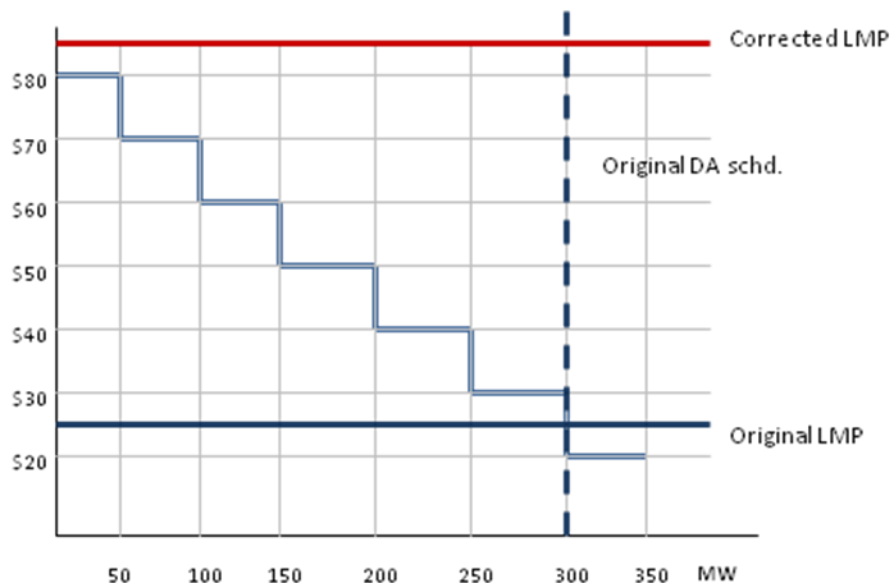

MW	\$
0	80
50	70
100	60
150	50
200	40
250	30
300	20
350	20

**Figure 3. Example 1 Price Correction from \$23 to \$85 and Bid Curve**

Example 1 calculation is performed as follows:

- Charge from Ex-post LMP settlement =  $300 * \$85 = \$25500$
- If the final energy schedule MW is greater than or equal to the higher end of the bid segment MW range, then the entire bid segment counts:
- Make Whole Payment \$ =  $\text{Max}(0, (\text{higher end of bid segment} - \text{lower end of the bid segment}) * (\text{Ex-post LMP} - \text{bid price}))$

- 
- Calculate the \$ =  $(50\text{MW}-0\text{MW}) * (\$85-\$80) + (100\text{MW}-50\text{MW}) * (\$85-\$70) + (150\text{MW}-100\text{MW}) * (\$85-\$60) + (200\text{MW}-150\text{MW}) * (\$85-\$50) + (250\text{MW}-200\text{MW}) * (\$85-\$40) + (300\text{MW}-250\text{MW}) * (\$85-\$30)$ 
    - $\$9000 = \$250 + \$750 + \$1250 + \$1750 + \$2250 + \$2750 = \text{Make whole payment}$
  - Settlement minus Make-Whole payment:  $\$25500 - \$9000 = \$16500$
  - Implicit LMP =  $\$16500 / 300\text{MW} = \$55/\text{MW}$

In Example 2, suppose the DA price is corrected from \$23 to \$55 and the original bid was accepted for 500MW, and only a portion of which was economic after price correction. The following would occur:

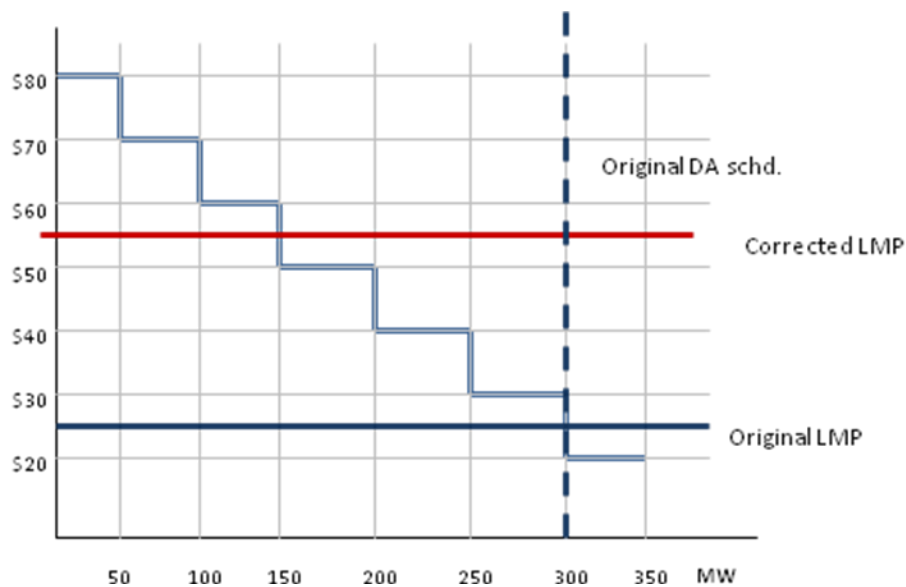

MW	\$
0	80
50	70
100	60
150	50
200	40
250	30
300	20
350	20

**Figure 4. Example 2 Price Correction from \$23 to \$55 and Bid Curve**

Example 2 calculation is performed as follows:

- Charge from Ex-post LMP settlement =  $300 * \$55 = \$16500$
- If the final energy schedule MW is less than the higher end of the bid segment MW range, then only the range between the lower end and the schedule MW counts,
- Make Whole Payment \$ =  $\text{Max}(0, (\text{Final schedule MW} - \text{lower end of the bid segment MW}) * (\text{Ex-post LMP} - \text{bid price}))$

- 
- Calculate the \$ =  $(200\text{MW}-150\text{MW}) * (\$55-\$50) + (250\text{MW}-200\text{MW}) * (\$55-\$40) + (300\text{MW}-250\text{MW}) * (\$55-\$30)$
  - $\$2250 = \$250 + \$750 + \$1250 = \text{Make whole payment}$
  - Settlement minus Make-Whole payment:  $\$16500 - \$2250 = \$14250$
  - Implicit LMP =  $\$14250 / 300\text{MW} = \$47.50/\text{MW}$

### ➤ **E.2.3 Make Whole Publishing and Reporting**

Details on the publishing of Make Whole Corrections are described in this section.

- The correction Make Whole price will be available on OASIS for the given Pnode. This is posted at T+5 as part of the existing T+5 price correction process.
- CMRI will display the **Derived LMP** at the resource level. This will also be available at T+5.
- In Settlements, (CC6011 or 6051), the **Derived LMP** shall be utilized on the initial Settlement Statement.

An aggregation by market of the correction amounts will be provided on the existing *Monthly Market Performance Report*. The report is located at <http://www.caiso.com/2424/2424d03b3f610.html>.

# **Attachment G**

## **PROCESS FOR ADDRESSING MARKET ISSUES**

---

## **G. Process for Addressing Market Issues**

### **G.1 Definition Market Issues**

A market issue can be any issue that may indicate the market is not performing efficiently, effectively or as designed. Thus, a market issue may involve market design flaws, software implementation and modeling anomalies or errors, market data anomalies or errors, and economic inefficiencies that have a material effect on the CAISO Markets. Market issues may relate to, but are handled separately from: 1) Energy or Ancillary Services prices found to be erroneous and corrected pursuant to the price correction process within the Price Correction Time Horizon as described in Section 8 of the BPM for Market Operations; or 2) Market Participant disputes managed through the Settlements dispute process described in Section 11 and 13 of the CAISO Tariff.

### **G.2 Managing Market Issues**

The CAISO maintains a Market Issues Steering Committee and Market Issues Sub-Committee to investigate market issues. The Steering Committee is chaired by the Vice President of Market Quality and Renewable Integration and includes Director level representatives from all affected business units. In addition, representative from the Department of Market Monitoring participate but are not members. The Sub-Committee is staffed with subject matter experts from all affected business units. Representatives from the Department of Market Monitoring may also participate in Sub-Committee meetings.

All possible market issues are submitted to the Market Issues Sub-Committee for initial review and evaluation. If it determines that there is market issue, the Steering Committee will determine whether the market issue should be communicated to Market Participants. In general, the CAISO will communicate all market issues that may have the potential to impact Market Participants unless communication of the issue pose a breach of confidentiality or could potentially create incentives for adverse market behavior.

Depending on the nature of the market issue, the communication may occur through one of the CAISO's market related participant conference calls or one of the CAISO's meetings such as the Market Performance and Planning Forum, but may also occur through market notices. To the extent that the Market Issue only



affects specific market participants and does not affect the market as whole, the CAISO will communicate separately with the affected Market Participants.

For significant market issues, the CAISO may publish a Market Issue Bulletin. A Market Issue Bulletin will include more in-depth analysis of the issue as well as an estimate of the market impact. The Market Issue Bulletin will also discuss any proposed actions the CAISO has or will be taking, including any mitigation measures.

### **G.3 Compliance Issues**

A market issue may involve a tariff or other compliance issue. If so, and if the CAISO cannot remedy the compliance issue by, for example, resettlement of the market consistent with the tariff, the CAISO may file a tariff waiver request with FERC. It is also the CAISO's policy to submit confidential self-reports of instances of potential non-compliance to the FERC Office of Enforcement.

# **Attachment H**

## **Circular Schedule Rule**

## H. Circular Schedule Rule

The following attachment presents further details in support of the CAISO Tariff section 11.33 and 30.5.5

### H.1 Overview

This document provides explanation of the settlement implications from engaging in a prohibited practice known as “circular scheduling.” Circular scheduling refers generally to the delivery of market import and export schedules that have a source and sink in the same balancing authority area. Such schedules typically would involve transmission segments in a second balancing authority area.

One type of circular schedule is illustrated through an example below. This example consists of a market schedule to import power to the ISO using one intertie and export this power at another intertie. In this case, an export is scheduled to Node B, and an import is scheduled from Node C back to ISO. Node C can be in a different balancing authority area than Node B.

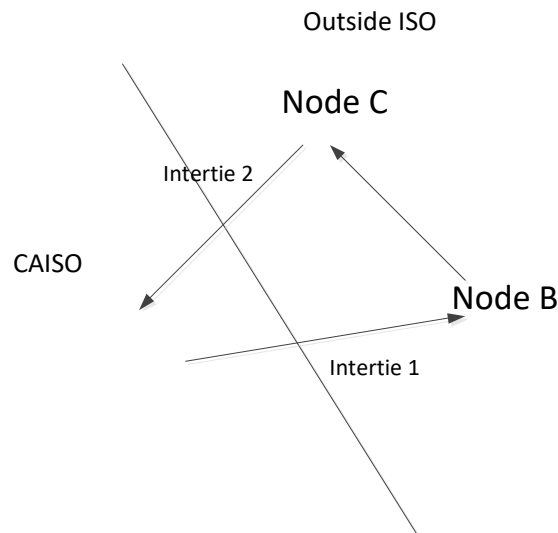

The actual circular nature of the combined import and export schedules awarded in the ISO markets is not apparent based only on review of the bids or self-schedules submitted in the ISO markets. Rather, it is necessary for the ISO to review the corresponding e-Tags to confirm that the entity procured external transmission and thus

---

created a closed loop of energy. The e-tags show the energy schedules exported from the ISO actually being scheduled on the transmission market outside the ISO (from Node B to Node C).

The power scheduled for export from the ISO would be returned on a transmission network outside the ISO back to the ISO causing the circular schedules to not produce actual flow of power. However, a market participant could profit from the circular schedules by earning the price difference between the points at which the energy was scheduled to be imported to, and exported from, the ISO.

Section **Error! Reference source not found.** describes how one type of circular schedule is addressed in the ISO markets.

## H.2 Circular Schedule Rule

The purpose of the circular schedule settlement rule is to negate the incentive to submit bids (including self-schedules) that would lead to such transactions. Specifically, the import portion of a prohibited circular schedule will be settled at the lower of the: (a) LMP of the scheduling point for the import portion of the schedule in the market in which the import portion of the schedule was awarded; or (b) LMP of the scheduling point for the export portion of the schedule in the market in which the export portion of the schedule was awarded.

The process flow for identifying prohibited circular schedules and applying the settlement rule is described below:

- Identify all single scheduling coordinator circular schedules sourcing and sinking in the same balancing authority area.
- Identify single scheduling coordinator circular schedules meeting the following exceptions. If one of these four conditions is met then the schedule will not be subject to the settlement rule. If the exception were removed from consideration and the resulting hypothetical schedule could have an E-Tag reflecting a source and sink in the same BAA, then the circular schedule will still be subject to the settlement rule:
  - a. The circular schedule includes a transmission segment on a DC Intertie.
  - b. The circular schedule involves a Pseudo-Tie generating unit delivering energy from its Native Balancing Authority Area to an Attaining Balancing Authority Area.

- c. The circular schedule is used either to: (i) serve Load that temporarily has become isolated from the CAISO Balancing Authority Area because of an Outage; or (ii) deliver Power from a Generating Unit that temporarily has become isolated from the CAISO Balancing Authority Area because of an Outage.
  - d. The circular schedule involves a Wheeling Through transaction that the Scheduling Coordinator can demonstrate was used to serve load located outside the transmission and Distribution System of a Participating TO.
    - i. To qualify for this exception, the ISO will require that a representative of the Scheduling Coordinator with the authority to bind the company provide a signed document attesting to the fact that the company serves load at the location that will be the ultimate sink of the wheel. The ISO will then provide the entity with a special resource ID to use for scheduling the wheel. If the e-Tag for a wheeling transaction reflects such a resource ID as the sink of the transaction, then the ISO's systems will be configured not to apply the settlement rules.
- Compare the output IFM and FMM bid LMPs for the respective schedules
  - Settle the Import to the ISO at the lower of LMPs at scheduling points for import and export for the MW in IFM and FMM
  - Calculate the profit by computing the differences in prices between import and export with the circular schedules in the market in which the import was scheduled. The total profit is computed by taking the difference of export settlements and import settlements.

For FMM Profit:

$$((MW_{RTM}) * PRICE_{FMM, last}) - ((MW_{RTM}) * PRICE_{FMM, T1})$$

For DA Profit:

$$((MW_{IFM}) * PRICE_{IFM, last}) - ((MW_{IFM}) * PRICE_{IFM, T1})$$

Where  $MW_{HASP}$  is the circular schedule MW in FMM market.

$PRICE_{FMM, last}$  is the price in FMM for the last segment, similarly  $PRICE_{FMM, T1}$  is the cleared price in FMM market for the schedules of the first segment.

- Compare the output IFM and FMM bid LMPs for the respective schedules
- Settle the Import to the ISO at the lower of LMPs at scheduling points for import and export for the MW in IFM and FMM
- Calculate the profit by computing the differences in prices between import and export with the circular schedules in the market in which the import was scheduled. The total profit is computed by taking the difference of export settlements and import settlements.

For FMM Profit:

$$((MW_{RTM}) * PRICE_{FMM,last}) - ((MW_{RTM}) * PRICE_{FMM,T1})$$

For DA Profit:

$$((MW_{IFM}) * PRICE_{IFM,last}) - ((MW_{IFM}) * PRICE_{IFM,T1})$$

Where  $MW_{HASP}$  is the circular schedule MW in FMM market.

$PRICE_{FMM,last}$  is the price in FMM for the last segment, similarly  $PRICE_{FMM,T1}$  is the cleared price in FMM market for the schedules of the first segment.

## **Attachment I**

# **Implementation of Marginal Cost of Losses and Transmission Losses for Facilities on the CAISO Controlled Grid outside the CAISO Balancing Authority Area**

## **I.1 Implementation of Marginal Cost of Losses and Transmission Losses for Facilities on the CAISO Controlled Grid outside the CAISO Balancing Authority Area**

### **I.1.1 Background**

This attachment is based on CAISO Tariff Section 27.1.1.2.

Section 27.1.1.2 provides in part that:

For CAISO Controlled Grid facilities outside the CAISO Balancing Authority Area, the CAISO shall assess the cost of Transmission Losses to Scheduling Coordinators using each such facility based on the quantity of losses agreed upon with the neighboring Balancing Authority multiplied by the LMP at the PNode of the Transmission Interface with the neighboring Balance Authority Area.

For the purposes of this discussion, facilities that are on the CAISO Controlled Grid but are not in the CAISO Balancing Authority Area (CAISO BAA) are referred to herein as the *Subject Facilities*. Section 27.1.1.2 ensures that scheduling coordinators are only charged for losses attributed to schedules coming to the CAISO BAA through *Subject Facilities* based on the quantity of losses agreed upon with the neighboring Balancing Authority multiplied by the LMP at the PNode of the Transmission Interface with the neighboring Balancing Authority Area.

This provision also ensures that the CAISO does not charge for the marginal cost of losses (MCL) that reflects the resistive component of the losses on the *Subject Facilities* to schedules that use the *Subject Facilities*. The LMP at such locations will only reflect a MCL for the CAISO Controlled Grid that is in the CAISO BAA and will not reflect the MCL on the *Subject Facilities* outside the CAISO BAA.

### **I.1.2 Implementation**

The location for the calculation of the Transmission Losses must be selected at a Location where the external BAA ends and the CAISO BAA begins for that power flow. This is based on the presumption and operational practice that the external BAA is accounting for losses on the *Subject Facilities*, and not the CAISO. In order to calculate losses at the correct location consistent with this requirement, the CAISO uses the tie location at which losses are scheduled back to the neighboring Balancing Authority Area. The external tie point loss matrix shown below provides a mapping of such locations depending on where the schedule is submitted to enter into the CAISO Controlled Grid.



The MCLs calculated for Locations within the CAISO Balancing Authority Area shall not reflect the cost of Transmission Losses on *Subject Facilities*. Because of this requirement, the CAISO calculates the LMPs for such transactions by zeroing out the resistive component for power flows on the *Subject Facilities*. This provision does not preclude the CAISO from applying the MCLs attributed to such power flows on the CAISO Controlled Grid that is within the CAISO BAA. Therefore, the Marginal Cost of Losses of the LMP for transactions using the *Subject Facilities* is based on the same “border location” approach. In summary, the CAISO calculates an LMP that includes a MCL based on the assumption that the power is physically injected at the CAISO border with the neighboring BAA who is owed the losses. This is accomplished by calculating an LMP that is derived by replacing the MCL component of the original LMP, with a MCL component from the LMP at the injection location on the border of the CAISO BAA.

Note that the above loss adjustments will be made only to the resource specific prices and not to the nodal prices in OASIS. Market participants will be able to validate their settlements statements with CMRI reports.

Scheduling Points Matrix					
Balancing Authority	Scheduling Point	TNAME	Scheduling Point Pnode	TNAME Border	Border PNode
APS	Four Corners	FOURCORNE345	FOURCORN_5_N501	NORTHGILA69	NGILA1_5_N001
APS	Moenkopi	MOENKOPI500	MOENKOPI_5_N101	NORTHGILA69	NGILA1_5_N001
LDWP	Gonder	GONIPP	GONDER_2_N501	SYLMAR	SYLMARLA_2_N501
LDWP	Intermountain	IPP	INTERM1G_7_N501	SYLMAR	SYLMARLA_2_N501
LDWP	Intermountain	IPPUTAH	INTERMT_3_N506	SYLMAR	SYLMARLA_2_N501
LDWP	Marketplace 500	MARKETPLACE	MARKETPL_5_N501	SYLMAR	SYLMARLA_2_N501
LDWP	McCullough 500	MCCULLOUG500	MCCULLGX_5_N501	SYLMAR	SYLMARLA_2_N501
LDWP	Mona	MDWP	MONA_3_N501	SYLMAR	SYLMARLA_2_N501
LDWP	NOB	NOB	SYLMARDC_2_N501	SYLMAR	SYLMARLA_2_N501
WALC	Mead 230kv	MEAD2MSCHD	MEADN_2_N501	MEAD230	MEADS_2_N101
WALC	Mead 500kv	MEAD5MSCHD	MEAD_5_N501	MEAD230	MEADS_2_N101
WALC	Westwing 500	WESTWING500	WESTWING_5_N501	MEAD230	MEADS_2_N101

### Example

The following example demonstrates how the LMP is calculated for external tie point transactions based on the matrix above.

A market participant schedules an import transaction at Westwing 500 using 'SCID\_WESTWING500\_I\_F\_123456' resource ID.

Scheduling PNode	Point		Border PNode	Point	
WESTWING_5_N501			MEADS_2_N101		
	Energy:	25		Energy:	25
	Congestion:	8		Congestion:	2
	Loss:	-1		Loss:	3
	LMP:	32		LMP:	30

The resource's LMP will be constructed using the energy and congestion components of the scheduling point PNode, and the marginal cost of losses from the border PNode for any scheduled transaction.

Resource Specific Price	
SCID_WESTWING500_I_F_123456	
Energy:	25
Congestion:	8
Loss:	3
LMP	36

## **Attachment J**

# **Calculation of Weekly Mileage Multipliers**

## A. Calculation of Weekly Mileage Multipliers

### J.1 Introduction

Procurement of the regulation up and regulation down ancillary services is based on a capacity requirement and a Mileage requirement. The Mileage requirement represents the expected amount of system-wide generation travel required to provide the service. For each hour, the Mileage requirement is calculated as the minimum of three quantities, one of which is the product of each regulating service's capacity requirement and a System Mileage Multiplier. The System Mileage Multiplier is the amount of total expected resource movement (up or down), or Mileage, from 1 MW of Regulation Up or Down capacity, respectively.

Resources certified for Regulation Up or Down have a resource-specific Mileage Up or Down multiplier. The resource-specific Mileage multiplier is used by the market in determining the maximum Mileage a resource could be awarded.

This attachment describes the process for calculating the System Mileage Multipliers and resource-specific Mileage multipliers.

### J.2 System Mileage Multiplier

The CAISO calculates hourly system Mileage multipliers from the actual Mileage over the prior 7 days for each hour. The CAISO performs the calculation by summing the total Mileage from all resources over the 7-day period for a given hour and dividing by the Regulation capacity procured in that 7-day period in that hour. For example, in Table 1 below, the System Mileage Multiplier that will be used for HE 08 of the next Friday would be 3.61.

**Table 1 – Example of calculation of System Mileage Multiplier for HE 08**

HE 08	Friday	Saturday	Sunday	Monday	Tuesday	Wednesday	Thursday	Total
Capacity	350	400	375	350	375	375	350	2575
Resource A Mileage	800	600	400	100	250	500	600	3250
Resource B Mileage	500	500	500	250	300	400	300	2750
Resource C Mileage	700	600	700	100	500	200	500	3300
Total Mileage	2000	1700	1600	450	1050	1100	1400	9300
Mileage Multiplier	5.71	4.25	4.27	1.29	2.80	2.93	4.00	3.61

A resource's hourly total Mileage Up or Down is the total movement while on Regulation. Each Mileage increment is the absolute change in Automatic Generation Control set points above or below the Dispatch Operating Points between 4 second intervals, with some

adjustment for underperformance. A total movement is then calculated as the total of the Automatic Generation Control set point changes over a 15-minute period. An hourly value is calculated as the sum of four 15-minute periods applicable to the hour.

### J.3 Calculation of resource specific Mileage multipliers

The resource-specific Mileage multiplier is based upon historical accuracy and the certified ramp capability. The resource-specific expected Mileage quantity that is dependent on the resource's operational characteristics is calculated as follows:

**Table 2 - An Example of Calculation of Resource-Specific Mileage Multiplier**

A1	System wide mileage multiplier based upon prior week	5	5	5	5	5	5
A2	System wide accuracy based upon prior week	90%	90%	90%	90%	90%	90%
A3	# of minutes to reach certified capacity (integer only, 1 to 10)	1	10	1	10	1	10
A4	Historical Resource Accuracy (%)	100%	100%	50%	50%	90%	90%
A5	Certified regulation capacity (MW)	20	20	20	20	20	20
A6	Resource specific mileage multiplier = $A1 * (10/A3) * (A4/A2)$	55.6	5.6	27.8	2.8	50.0	5.0
	Maximum mileage that can be awarded = $A5 * A6$	1111	111	556	56	1000	100

#### Key Terms

$10/A3$  = Relative Movement between fast & slow resources

$A4/A2$  = Relative Accuracy of Resource & System

The relative ramp capability ( $10/A3$ ) allows faster resources to be awarded additional Mileage. Since all regulation capacity is certified using a 10 minute ramp, the relative ramp capability allows a resource that can reach its full certified capacity sooner to be awarded additional Mileage. In the example above, if we assume a resource can reach 20 MW in 4 seconds (round to 1 minute) and a second resource can reach its certified capacity in 9.5 minutes (round to 10 minutes), the faster resource can be awarded ten times more mileage per 1MW of regulation capacity compared to the slower resource. The value A3 is based on the best Operational Ramp Rate curves registered in the Master File.

The relative accuracy of a resource compared to the system accuracy from the prior 7 days ( $A4/A2$ ) allows more accurate resources to be awarded more Mileage per 1MW of regulation capacity than less accurate resources. As illustrated above, when both the fast resource and the slow resource have better accuracy than the system accuracy from the prior 7 days, both resources have a resource-specific Mileage multiplier greater than the system wide Mileage multiplier.

The ISO will calculate a resource's Historic Regulation Performance Accuracy (A4) based on a rolling thirty day simple average of 15 minute accuracy measurements. Separate accuracy

---

calculations will be made for Regulation Up and Regulation Down. For newly certified or recertified resources, it shall be set initially to the average 30-day Historic Regulation Up Performance Accuracy among all certified resources. The last calculated value shall be retained when the resource has not been scheduled for regulation up during the period of the rolling 30 days at all. The CAISO will sum a resource's Automatic Generation Control set points for each four (4) second Regulation interval every fifteen (15) minutes and then sum the total deviations from the Automatic Generation Control set point for each four (4) second regulation interval during that fifteen (15) minute period, to compare the two for calculating a 15-minute accuracy.

For purposes of its accuracy calculations, the ISO will count only those 4 second intervals in which the ISO provides a resource with an Automatic Generation Control signal to move in an up or down direction. The ISO will exclude those 4 second intervals from its accuracy measurements in which the ISO signals a resource to maintain operation at or near their last dispatch operating point. Accordingly, for the Regulation Up accuracy calculation, the ISO will only count four (4) second intervals in which the Automatic Generation Control set point value is higher than the dispatch operating point by a value equal to or greater than the maximum of 0.1 percent of the resource's Regulation Up award or 0.1 MW. The ISO will still calculate instructed mileage for these intervals regardless of the tolerance band. For the Regulation Down accuracy calculation, the ISO will only count four (4) second intervals in which the Automatic Generation Control set point is lower than the dispatch operating point by a value equal to or greater than maximum of the 0.1 percent of the resource's Regulation Down award and 0.1 MW. The ISO will still calculate instructed mileage for these intervals regardless of the tolerance band.

In the event that no Mileage occurs in a fifteen minute interval, the ISO will not include the 15 minute interval in calculating the resource's historical accuracy

The system wide accuracy numbers (A2) for Regulation Up and Regulation Down is a 7-day rolling average of the historical accuracy of all resources providing Regulation Up and Regulation Down, respectively.

# **Attachment K**

## **Exceptional Dispatch**



---

## K. Exceptional Dispatch

### K.1 Introduction

Exceptional Dispatch is defined in CAISO Tariff sections 34.11. Additional references can be found throughout the tariff and most are summarized in Table 1 below. Exceptional Dispatch refers generally to a subset of manual commitment or dispatch instructions that are not determined as a result of the market software in the IFM, RUC, FMM or RTM. CAISO operators can issue Exceptional Dispatches through the CAISO's Automated Dispatch System (ADS) or direct communication with the Scheduling Coordinator (SC) and, at times, direct communication with the resource operator.

There are several categories of Exceptional Dispatch, all of which are summarized in Attachment K. Exceptional Dispatch may be used generally to prevent or manage System Emergencies and Market Disruptions and to address transmission modeling and other modeling and software limitations as well as for other purposes such as issuing tests for a variety of purposes<sup>9</sup>. Exceptional dispatches may be incremental or decremental and may require a resource to start-up or shut-down.

Exceptionally dispatches will be settled in accordance with the exceptional dispatch energy settlement rules.

A resource that received an exceptional dispatch that requires it to start-up or utilize capacity that is not subject to a Resource Adequacy contract or other capacity contract, may be eligible for a Capacity Payment Mechanism ("CPM") designation for 30 or 60 days or Supplemental Revenues. CPM and Supplemental Revenues for eligible resources are addressed in Article 5 of the Business Practice Manual for Reliability Requirements.

- Table 1 identifies categories of Exceptional Dispatch and the related tariff section.
- Table 2 lists key tariff sections relevant to Exceptional Dispatch.

### K.2 Categories and Applications of Exceptional Dispatch

There are several categories of Exceptional Dispatch, and under some of these categories there are several different types of instructions. Some types of Exceptional Dispatch will happen only in particular system or market operational time-frames while others will occur due to events on the grid.<sup>10</sup> Table 1 below lists the general categories and market timeframes for Exceptional Dispatch:

---

<sup>9</sup> A Market Disruption is defined as an action or event that causes a failure of a CAISO Market, related to system operation issues or System Emergencies. See CAISO Tariff Sections 7.6 and 7.7, respectively.

<sup>10</sup> Exceptional Dispatch Operating Procedures offer additional information. The day-ahead Operating Procedure for Exceptional Dispatch (OP 1330) is available at the following link: <http://www.aiso.com/Documents/1330.pdf>. The real-time Operating Procedure for Exceptional Dispatch (OPs 2330; 2330A, 230C, 230D and 230E) are

**Table 1 – Categories and Applications of Exceptional Dispatch**

<b>Category of Exceptional Dispatch</b>	<b>Types of Applications (not exhaustive)</b>	<b>System or Market Operational Time-frame</b>
Prevent or minimize <b>System Emergency</b> or threat to System Reliability (section 34.11.1), to mitigate for over-gen (section 34.11.2 (4)) to mitigate or prevent a Market Disruption (section 34.11.2(9)), Energy for voltage support (34.11.2 (6)), and instructions to reverse the operating mode of pumped storage hydro (section 34.11.2 (8)); Reversal of non-optimal commitments in IFM (Section 34.11.2 (10))	This category includes exceptional dispatches for forced generation and transmission outages; unplanned fuel limitations; over-generation events; to address market disruptions, and to issue exceptional dispatches to Extremely Long Start units outside of the manual commitment process for ELS units.	Day-Ahead commitments typically made after the Day Ahead Market runs;  Real-Time operations; decommitments and decremental dispatches made after the Day-Ahead schedule and awards are published; or in Real-time. If circumstances warrant, exceptional commitments may be made in advance of the Day-Ahead market.
<b>Transmission-Related Modeling Limitations</b> for which the transmission owner is responsible (Section 34.11.3)	This category includes (1) transmission modeling limitations that arise from transmission maintenance (includes exceptional dispatches need to support a planned transmission outages that cannot be modeled or fully modeled in the FNM); (2) lack of Voltage Support at proper levels; and (3) and lack of or incomplete information about the transmission network that the PTO is responsible for	Day-Ahead Commitments typically made after the Day Ahead Market runs
<b>Non-Transmission related modeling or software limitation</b> (Section 34.11.3)	This category includes all modeling limitations (including transmission related modeling limitations) that do not meet at least one of the three criteria for transmission-related	Day-Ahead Commitments typically made after the Day Ahead Market runs;  Real-Time operations

available at the following link: <http://www.caiso.com/Pages/documentsbygroup.aspx?GroupID=F52A58E8-C78A-4E64-BA7B-CE2AF30453C0>.

	modeling limitation (see above). These include non-transmission limitations such as environmental constraints including Delta Dispatch; resource specific constraints that are not modeled; planned fuel limitations due to planned gas pipeline limitations that are not modeled; and any other condition for which the timing of the RT market and system modeling are either too slow or incapable of bringing the grid back to reliable operation.	
Adjustment of other market schedules to <b>accommodate TOR or ETC</b> <b>Self-Schedule</b> changes (Section 34.11.2)	This category includes all TOR and some ETC that have rights to change their self-schedule after the HASP market close	After Market Close of HASP including after the FMM and Real-time Market runs, if applicable.
<b>Voltage Support and Black Start</b> (Section 34.11.2)	This category includes voltage support instructions; and black start commitment and instruction however if a resources is committed or issued an incremental exceptional dispatch for voltage support, the ED is categorized as a Transmission-Related Modeling Limitation ED.	Voltage support instructions beginning after the Day-Ahead Market or in Real-Time; Black Start as needed for recovery
Ancillary Services <b>testing</b> ; pre-commercial operations testing; and other periodic resource testing, including PMax testing (Section 34.11.2)	Ancillary Services testing; pre-commercial operations testing; and other periodic resource testing, including PMax testing	In real-time
<b>RMR Condition 2</b> (Sections 34.11.1 and 41.9)	RMR Condition 2 units are available for non-RMR contract use under limited circumstances	See CAISO Tariff section 41.9 for requirements.
<b>Tie Emergency</b> (Section 42.1.5)	To buy or sell energy or other services to neighboring Balancing Authority Areas or other	As agreed

	inter-tie transactions	
--	------------------------	--

Table 2 – Distinct list of the Market Reasons mapped to FERC No. 844 Reasons

<b>Reason</b>	<b>FERC Order No. 844 Reason</b>
AS Testing	N/A
Black Start	constraint management
Bridging Schedules	constraint management
Conditions beyond the control of the CAISO	N/A
Contingency Dispatch	constraint management
CP	N/A
Delta Dispatch	constraint management
Emergency Assistance	system-wide capacity
Fast Start Unit Management	system-wide capacity
Fire Threats	system-wide capacity
Incomplete or Inaccurate Transmission	constraint management
IROL	constraint management
Load Forecast Uncertainty	system-wide capacity
Load Pull	system-wide capacity
Market Disruption	N/A
Non-Local Reliability	system-wide capacity
Operating Procedure Number and Constraint	constraint management
Other Reliability Requirement	constraint management
Overgeneration	system-wide capacity
Planned Gas Outages	constraint management
Planned Transmission Outage	constraint management
Pump Management	constraint management
Ramping Capacity	system-wide capacity
Reverse Commitment Instruction	constraint management
Software Limitation	N/A
SOL	constraint management
Start-Up Instructions	N/A
Transmission Testing	constraint management
Unit Testing	N/A
Unplanned Outage	constraint management

Voltage Support	voltage support
Weather Concerns	system-wide capacity

### K.3 Sections of the CAISO Tariff that address Exceptional Dispatch

**Table 2 – Key Sections of the CAISO Tariff that address Exceptional Dispatch**

Tariff Section	Exceptional Dispatch Rules
7.7.15.1 Actions in the Event of a Market Disruption, to Prevent a Market Disruption or to minimize the Extent of a Market Disruption	Identifies Exceptional Dispatch as an Action to prevent or manage Market Disruption
11.5.6 Settlement Amounts for IIE from Exceptional Dispatch	Determination of Settlement Amounts for IIE from various types of Exceptional Dispatch; Allocation of Excess Cost Payments; Pricing of Exceptional Dispatch of RMR units
11.8.2.1.1 IFM Start-Up Cost 11.8.3.1.1 RUC Start-Up Cost 11.8.4.1.1 RTM Start-Up Cost	Impact of Exceptional Dispatch de-commitment on recovery of IFM, RUC and RTM start-up costs
11.8.4.1.2 RTM Minimum Load Costs	Minimum load costs of resources exceptionally dispatched are included in BCR
11.8.4.1.5 RTM Energy Bid Costs	Energy bid costs of resources exceptionally dispatched are included in BCR
27.5.2 Metered Subsystems 31.3.3 Metered Subsystems	Use of Exceptional Dispatch to resolve congestion caused by MSS and allocation of costs to MSS
31.5.1.4 Eligibility to Set the RUC Price	Resources are not eligible to set RUC prices if CAISO enforces a resource-specific constraint due to an Exceptional Dispatch
31.5.5 Selection and Commitment of RUC Capacity	Exceptional Dispatch is used to decommit units scheduled in IFM and evaluated in RUC
34.11 Exceptional Dispatch	Describes types of Exceptional Dispatches, including System Reliability Exceptional Dispatches (34.11.1), Other Exceptional Dispatch (34.11.2), Transmission-Related Modeling Limitations (34.11.3) and Reporting Requirements (34.11.4)
34.17.6 Intra-Hour Exceptional Dispatches	Real-Time dispatch rules for the special case where an Exceptional Dispatch begins in the new hour

---

34.18 Real-Time Dispatch of RDRRs	CAISO can issue Exceptional Dispatches of RDRRs for reliability or to perform a test
34.20.2.3 Eligibility to Set the Real-Time LMP	Resources are not eligible to set Real-Time LMPs if CAISO enforces a resource-specific constraint due to an Exceptional Dispatch
39.7.3 Default Competitive Path Assessment	Default Competitive Path Assessment will be used to determine whether an Exceptional Dispatch is for a non-competitive constraint
39.10 Mitigation of Exceptional Dispatches of Resources	Rules for mitigation of Exceptional Dispatches, including Supplemental Revenues
41.9 Exceptional Dispatch of Condition 2 RMR Units	Rules for Exceptional Dispatch of Condition 2 RMR units outside the terms of their contracts

# **Attachment L**

## **Generator Contingency and Remedial Action Scheme Formulation**

## L. Generator Contingency and Remedial Action Scheme Formulation

### L.1 Notation

The following notation will be used throughout:

$i$	node index
$m$	transmission constraint index
$k$	preventive contingency index
$g$	generation contingency index
$o_g$	node index for generator outage under generation contingency $g$
$N$	total number of nodes
$M$	total number of transmission constraints
$K$	total number of preventive contingencies
$K_g$	total number of generation contingencies
$S_{FR}$	set of supply resources with frequency response capability
$k$	superscript denoting preventive post-contingency values
$g$	superscript denoting generation post-contingency values
$\sim$	superscript denoting initial values from a power flow solution
$\forall$	for all...
$\Delta$	denotes incremental values
$u_i$	commitment status of generating resource $i$ (0: offline, 1: online)
$G_i$	generation schedule at node $i$
$G_{i,\min}$	minimum generation schedule at node $i$
$G_{i,\max}$	maximum generation schedule at node $i$
$L_i$	load schedule at node $i$
$C_i$	energy bid from generation at node $i$
$\mathbf{G}$	generation schedule vector
$g(\mathbf{G})$	power balance equation
$h_m(\mathbf{G})$	power flow for transmission constraint $m$
$F_m$	power flow limit for transmission constraint $m$
$Loss$	power system loss
$LPF_i$	loss penalty factor for power injection at node $i$



---

$SF_{i,m}$	shift factor of power injection at node $i$ on transmission constraint $m$
$GDF_{o_g,i}$	generation loss distribution factor of generation contingency $g$
$LMP_i$	locational marginal price at node $i$
$\lambda$	system marginal energy cost (shadow price of power balance constraint)
$\mu_m$	shadow price of transmission constraint $m$
$\delta_{o_g,i}$	Binary parameter (0 or 1) that identifies the generator node with generator outage under generation contingency $g$

## L.2 Simplifying assumptions

To simplify the mathematical formulation solely for the purpose of presentation, the following assumptions are made:

- There is a single interval in the time horizon, thus inter-temporal constraints are ignored.
  - There is a single Balancing Authority Area, thus Energy Imbalance Market Entities and Energy Transfers are ignored.
  - Imports and exports are ignored.
  - Unit commitment costs and variables are ignored, thus it is assumed that all generating resources are online and all Multi-State Generators are fixed in a given state.
  - Load bids are ignored, thus load is scheduled as a price-taker at the load forecast.
  - The energy bids cover the entire generating resource capacity from minimum to maximum.
  - There is a single energy bid segment for each generating resource.
- Ancillary services are ignored

## L.3 Mathematical formulation

The mathematical formulation of the complete preventive contingency optimization problem is as follows:

$$\min \sum_{i=1}^N C_i (G_i - G_{i,\min}) \quad (a)$$

subject to:

$$g(\mathbf{G}) = 0 \quad (b)$$

$$h_m(\mathbf{G}) \leq F_m, \quad m = 1, 2, \dots, M \quad (c)$$

$$h_m^k(\mathbf{G}) \leq F_m^k, \quad \begin{cases} m = 1, 2, \dots, M \\ k = 1, 2, \dots, K \end{cases} \quad (d)$$

$$G_i^g = G_i + GDF_{o_g,i} \cdot G_{o_g}, \quad \begin{cases} i = 1, 2, \dots, N \\ g = 1, 2, \dots, K_g \end{cases} \quad (e)$$

$$h_m^g(\mathbf{G}^g) \leq F_m^g, \quad \begin{cases} m = 1, 2, \dots, M \\ g = 1, 2, \dots, K_g \end{cases} \quad (f)$$

$$G_{i,\min} \leq G_i \leq G_{i,\max}, \quad i = 1, 2, \dots, N \quad (g)$$

Where:

(a) is the objective function comprised of the bid cost for energy.

(b) is the power balance constraint in the base case, which can be linearized around the base case power flow solution as follows:

$$g(\mathbf{G}) \equiv \sum_{i=1}^N (G_i - L_i) - Loss \cong \sum_{i=1}^N \frac{(G_i - \tilde{G}_i)}{L_{PF_i}} = 0$$

(c) is the set of transmission constraints in the base case, which can be linearized around the base case power flow solution as follows:

$$h_m(\mathbf{G}) \cong \tilde{h}_m(\tilde{\mathbf{G}}) + \sum_{i=1}^N SF_{i,m} (G_i - \tilde{G}_i) \leq F_m, \quad m = 1, 2, \dots, M$$

(d) is the set of transmission constraints in each preventive contingency case, which can be linearized around the post-contingency case power flow solution as follows:

$$h_m^k(\mathbf{G}) \cong \tilde{h}_m^k(\tilde{\mathbf{G}}) + \sum_{i=1}^N SF_{i,m}^k (G_i - \tilde{G}_i) \leq F_m^k, \quad \begin{cases} m = 1, 2, \dots, M \\ k = 1, 2, \dots, K \end{cases}$$

where the shift factors reflect the post-contingency network topology and the transmission power flow limits are the applicable emergency limits.

(e) is the generation loss distribution in the generation contingency state, which is assumed lossless and pro rata on the maximum online generation capacity from supply resources with frequency response capability, ignoring associated capacity and ramp rate limits. This value approximates the system response to loss of generation closely to how the system will actually behave. This value is used only to model flows placed on transmission in the contingency case, and is aligned with current operations engineering study practices:

$$GDF_{o_g,i} = \begin{cases} -1 & i = o_g \\ 0 & i \notin S_{FR} \wedge i \neq o_g \\ \frac{u_i G_{i,\max}}{\sum_{i \in S_{FR}, i \neq o_g} u_i G_{i,\max}} & i \in S_{FR} \wedge i \neq o_g \end{cases}, \quad \begin{cases} i = 1, 2, \dots, N \\ g = 1, 2, \dots, K_g \end{cases}$$

(f) is the set of transmission constraints in each generation contingency case, which can be linearized around the post-contingency case power flow solution as follows:

$$h_m^g(\mathbf{G}^g) \cong \tilde{h}_m^g(\tilde{\mathbf{G}}) + \sum_{i=1}^N SF_{i,m}^g (G_i^g - \tilde{G}_i) = \tilde{h}_m^g(\tilde{\mathbf{G}}) + \sum_{i=1}^N SF_{i,m}^g (G_i + GDF_{o_g,i} G_{o_g} - \tilde{G}_i)$$

$$\leq F_m^g, \quad \begin{cases} m = 1, 2, \dots, M \\ g = 1, 2, \dots, K_g \end{cases}$$

where the shift factors reflect the post-contingency network topology, which can be different than the base case if the contingency definition includes a transmission outage, and the transmission power flow limits are the applicable emergency limits.

$(g)$  is the set of the resource capacity constraints in the base case.

## Locational marginal prices

The locational marginal prices are as follows:

$$LMP_i = \frac{\lambda}{LPPF_i} - \sum_{m=1}^M SF_{i,m} \mu_m - \sum_{k=1}^K \sum_{m=1}^M SF_{i,m}^k \mu_m^k - \sum_{g=1}^{K_g} \sum_{m=1}^M \left( SF_{i,m}^g + \delta_{o_g,i} \sum_{i=1}^N SF_{i,m}^g GDF_{o_g,i} \right) \mu_m^g, \quad i = 1, 2, \dots, N$$

Where:

$$\delta_{o_g,i} = \begin{cases} 1 & i = o_g \\ 0 & i \neq o_g \end{cases}, \quad \begin{cases} i = 1, 2, \dots, N \\ g = 1, 2, \dots, K_g \end{cases}$$

Therefore, the marginal congestion contribution from a binding transmission constraint in a generator contingency to the locational marginal price at the node of the generator outage includes the impact of the assumed generation loss distribution.

A generator modeled in a generator contingency receives appropriate compensation taking into account its contribution to total production cost. The transmission constraint shadow prices are zero for constraints that are not binding in the base case or the relevant contingency case.

## Generator flow factors

Similar to how a traditional “shift factor” represents the control variable’s contribution to a particular constraint ( $SF_{i,m}$  and  $SF_{i,m}^k$ ), we can summarize a generator’s contribution to the generator preventive constraint cost for a particular monitored element as a “generator flow factor” (GFF) in order to simplify the locational marginal price calculation in the examples presented in this paper.

The GFF, or contribution to the generator contingency preventive constraint, is:

$$GFF_{i,m}^g = SF_{i,m}^g + \delta_{o_g,i} \sum_{i=1}^N SF_{i,m}^g GDF_{o_g,i}$$

The GFF for the all generators that are not the contingency generator ( $i \neq o_g$ ) simplifies to the network topology shift factor because each generator’s  $\delta_{o_g,i} = 0$ :

$$GFF_{i,m}^g = SF_{i,m}^g + \delta_{o_g,i} \sum_{i=1}^N SF_{i,m}^g GDF_{o_g,i} = SF_{i,m}^g + (0) \sum_{i=1}^N SF_{i,m}^g GDF_{o_g,i}$$

$$GFF_{i,m}^g = SF_{i,m}^g \quad \forall i \neq o_g$$

The GFF for the generator that is the contingency generator ( $i = o_g$ ) simplifies as follows:

$$GFF_{o_g,m}^g = SF_{o_g,m}^g + \delta_{o_g,i} \sum_{i=1}^N SF_{i,m}^g GDF_{o_g,i}$$

$$GFF_{o_g,m}^g = SF_{o_g,m}^g + (1) \sum_{i=1}^N SF_{i,m}^g GDF_{o_g,i} = SF_{o_g,m}^g + SF_{o_g,m}^g \cdot GDF_{o_g,i} + \sum_{\substack{i=1 \\ i \neq o_g}}^N SF_{i,m}^g GDF_{o_g,i}$$

$$GFF_{o_g,m}^g = SF_{o_g,m}^g + SF_{o_g,m}^g \cdot (-1) + \sum_{\substack{i=1 \\ i \neq o_g}}^N SF_{i,m}^g GDF_{o_g,i}$$

$$GFF_{o_g,m}^g = \sum_{\substack{i=1 \\ i \neq o_g}}^N SF_{i,m}^g GDF_{o_g,i}$$

This generator flow factor simplifies the locational marginal price calculation in the examples below. All generators not part of the generator contingency definition ( $i \neq o_g$ ) are charged  $GFF_{i,m}^g$  (simplified above to the network topology shift factor  $SF_{i,m}^g$ ) multiplied by the shadow cost of the generator contingency constraint ( $\mu_m^g$ ). The generator on contingency ( $i = o_g$ ) is charged  $GFF_{o_g,m}^g$  multiplied by the shadow cost of the generator contingency constraint ( $\mu_m^g$ ). It represents the total impact on the monitored element from all of the locations on the system to where the optimization distributes the lost generation.

## L.4 Examples

### L.4.1 Secure transmission after remedial action scheme operation

The three examples below illustrate how the remedial action scheme preventive constraint solution methodology impacts market dispatch, price formation, and settlement while ensuring the system is within its emergency limits immediately after a transmission loss and associated remedial action scheme generation loss. Each example has slightly different resource definitions and/or bidding behaviors.

#### L.4.1.1 Example 1 (normal limit binds)

In this example, we show the normal limit binding while the remedial action scheme preventive constraint does not bind, thereby showing that the remedial action scheme generator that still contributes to base case congestion is charged for base case congestion.

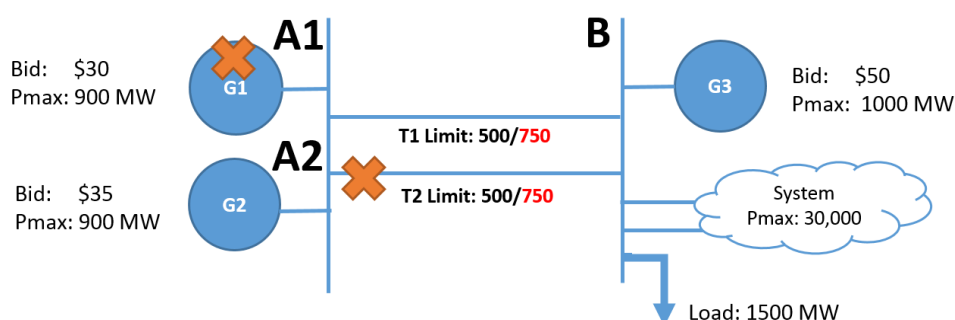

As shown using orange X's above, a remedial action scheme is defined such that if T2 is lost, G1 will be tripped offline. The total normal transfer limit between A and B is 1000 MW (500 MW on T1 plus 500 MW on T2). The total emergency transfer limit between A and B is 1500 MW (750 MW on T1 plus 750 MW on T2); however, given the simultaneous preventive loss of T2 and G1, an emergency transfer limit between A and B of 750 MW will be enforced.

#### Bids & Awards

Generators G1, G2, and G3 submit the following bids and receive the following energy awards given the enhanced market dispatch.

Generator	Energy Bid	Energy Award	LMP
G1	\$30	900	\$35
G2	\$35	100	\$35
G3	\$50	500	\$50

The market dispatches the cheapest energy on G1 up to its Pmax of 900 MW followed by the next cheapest energy from G2. The normal transfer limit between A and B of 1000 MW binds, and the market dispatches G3 for the remaining 500 MW necessary to serve 1,500 MW of load.

### Modeled Flows

1,000 MW flow from A to B in the base case and the normal constraint binds. Only 125 MW flow from A to B in the remedial action scheme preventive case, which does not bind. Note that the remedial action scheme preventive constraint does not bind because only 125 MW would flow from A to B after the loss of T2 and remedial action scheme operation that removes G1 from service; all of which is modeled as being produced from bus A.

Base case flows from A to B are calculated:

$$\text{Flow}_{AB}^0 = \text{G1 Energy Award} \cdot (\text{SF}_{A1,AB}^0) + \text{G2 Energy Award} \cdot (\text{SF}_{A2,AB}^0) + \text{G3 Energy Award} \cdot (\text{SF}_{B,AB}^0)$$

$$1,000 \text{ MW} = 900 \cdot (1) + 100 \cdot (1) + 500 \cdot (0)$$

Base case flows of 1,000 MW are less than or equal to the normal transfer capability on the path and the constraint binds at a shadow cost ( $\mu_{AB}^0$ ) of \$15.

As discussed in Section **Error! Reference source not found.**, the system's response to G1's lost generation is distributed to each node on the system pro-rata based on each node's cumulative Pmax. Generator G1's contribution to flows on the path from A to B and consequently its contribution to this constraint's cost is calculated as a Generation Flow Factor ("GFF"):

$$\begin{aligned} \text{GFF}_{A1,AB}^{\text{RAS}} &= \sum_{\substack{i=1 \\ i \neq o_g}}^N \text{SF}_{i,m}^g \text{GDF}_{o_g,i} = \sum_{\substack{i=1 \\ i \neq o_g}}^N \text{SF}_{i,m}^g \frac{G_{i,max}}{\sum_{i \neq o_g} G_{i,max}} \\ &= (1) \cdot \frac{900}{31,900} + (0) \cdot \frac{1,000}{31,900} + (0) \cdot \frac{30,000}{31,900} = 0.028213 \end{aligned}$$

Remedial action scheme preventive case flows from A to B are calculated:

$$\text{Flow}_{AB}^{\text{RAS}} = \text{G1 Energy Award} \cdot (\text{GFF}_{A1,AB}^{\text{RAS}}) + \text{G2 Energy Award} \cdot (\text{GFF}_{A2,AB}^{\text{RAS}}) + \text{G3 Energy Award} \cdot (\text{GFF}_{B,AB}^{\text{RAS}})$$

$$125 \text{ MW} = 900 \cdot (0.028213) + 100 \cdot (1) + 500 \cdot (0)$$

Remedial action scheme preventive case flows of 125 MW are less than the emergency transfer capability on the path, given the remedial action scheme operation, and the constraint does not bind. There is a shadow cost ( $\mu_{AB}^9$ ) of \$0.

### Price Formation

Generator G1 is charged for its contribution to the congestion from A to B ( $SF^{0_{A1,AB}}$ ). In this example, it is charged congestion on the energy that flows on the binding normal constraint. Because bus A has a network topology shift factor of 1 ( $SF^{0_{A1,AB}}$ ) to the constraint, all of the energy (G1 Energy Award  $\cdot (SF^{0_{A1,AB}}) \cong 900$  MW) is charged  $\mu^{0_{AB}}$  in congestion.

Generator G2 is charged the \$15 in congestion from A to B because its full output has a network topology shift factor of 1 to the normal constraint ( $SF^{0_{A1,AB}}$ ). Generator G1 is charged approximately the same amount in congestion as any other generator that is contributing to the congestion (G1 and G2 are charged \$15 in congestion from A to B), while G3 which contributes nothing to the normal constraint ( $SF^{0_{B,AB}}$ ) is not charged.

Note that the contribution factors to the remedial action scheme preventive constraint ( $GFF^{RAS_{i,AB}}$ ) did not impact the energy prices because it had no shadow cost.

Generator (i)	$\lambda^0$	Normal		Loss of G1+T2		LMP
		$SF^{0_{i,AB}}$	$\mu^{0_{AB}}$	$GFF^{RAS_{i,AB}}$	$\mu^{RAS_{AB}}$	
G1	\$50	1	\$15	0.028213	\$0	\$35
G2	\$50	1	\$15	1	\$0	\$35
G3	\$50	0	\$15	0	\$0	\$50

Both G1 and G2 contribute to the normal limit congestion, therefore, both are charged the \$15 in congestion from A to B.

### Settlement

Generator/ Load	LMP	Energy Award	Energy Payment	Total Revenue
G1	\$35	900	\$31,500	\$31,500
G2	\$35	100	\$3,500	\$3,500
G3	\$50	500	\$25,000	\$25,000
Load B	\$50	-1500	-\$75,000	-\$75,000
Energy & Capacity				-\$15,000
CRR <sub>AB</sub>	\$15	750		\$11,250
Market Net				-\$3,750



### L.4.1.2 Example 2 (emergency limit binds)

In this example, we show the emergency limit binding, but because the remedial action scheme generator is minimally contributing to preventive case congestion, it is only charged a small amount for that congestion.

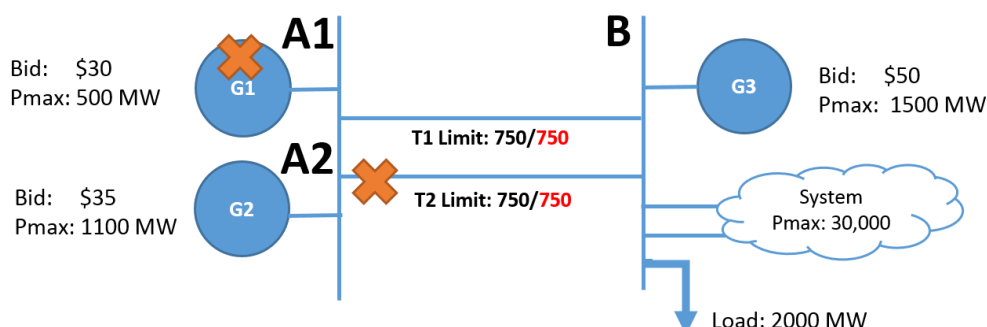

As shown using orange X's above, a remedial action scheme is defined such that if T2 is lost, G1 will be tripped offline. The total normal transfer limit between A and B is 1,500 MW (750 MW on T1 plus 750 MW on T2). The total emergency transfer limit between A and B is 1,500 MW (750 MW on T1 plus 750 MW on T2); however, given the simultaneous preventive loss of T2 and G1, an emergency transfer limit between A and B of 750 MW will be enforced. In this example, the transmission system is designed such that there is no additional transfer capability on T1 or T2 above normal limits.

#### Bids & Awards

Generators G1, G2, and G3 submit the following bids and receive the following energy awards given the enhanced market dispatch.

Generator	Energy Bid	Energy Award	LMP
G1	\$30	500	\$49.49
G2	\$35	733	\$35
G3	\$50	767	\$50

The market dispatches the cheapest energy on G1 up to its Pmax of 500 MW followed by the next cheapest energy from G2. The remedial action scheme preventive constraint transfer limit from A to B of 750 MW binds because of a 733 MW contribution to flow from G2 plus the additional contribution from the portion of the lost generator that was distributed to node A2 of 17 MW (733+17=750). The market dispatches G3 for the remaining 750 MW necessary to serve 2,000 MW of load.

### Modeled Flows

1,233 MW flow from A to B in the base case, and 750 MW flow from A to B in the remedial action scheme preventive case. Note that the remedial action scheme preventive constraint binds at 750 MW because a full 750 MW would flow from A to B after the loss of T2 and remedial action scheme operation that removes G1 from service; all of which is modeled as being produced from bus A.

Base case flows from A to B are calculated:

$$\begin{aligned} \text{Flow}_{AB}^0 &= \text{G1 Energy Award} \cdot (\text{SF}_{A1,AB}^0) + \text{G2 Energy Award} \cdot (\text{SF}_{A2,AB}^0) + \text{G3 Energy Award} \cdot (\text{SF}_{B,AB}^0) \\ 1,233 \text{ MW} &= 500 \cdot (1) + 733 \cdot (1) + 767 \cdot (0) \end{aligned}$$

Base case flows of 1,233 MW are less than the normal transfer capability on the path and the constraint does not bind.

As discussed in Section **Error! Reference source not found.**, the system's response to G1's lost generation is distributed to each node on the system pro-rata based on each node's cumulative Pmax. Generator G1's contribution to flows on the path from A to B and consequently its contribution to this constraint's cost is calculated as:

$$\begin{aligned} GFF_{A1,AB}^{RAS} &= \sum_{\substack{i=1 \\ i \neq o_g}}^N SF_{i,m}^g GDF_{o_g,i} = \sum_{\substack{i=1 \\ i \neq o_g}}^N SF_{i,m}^g \frac{G_{i,max}}{\sum_{i \neq o_g} G_{i,max}} \\ &= (1) \cdot \frac{1,100}{32,600} + (0) \cdot \frac{1,500}{32,600} + (0) \cdot \frac{30,000}{32,600} = 0.033742 \end{aligned}$$

Remedial action scheme preventive case flows from A to B are calculated:

$$\begin{aligned} \text{Flow}_{AB}^{RAS} &= \text{G1 Energy Award} \cdot (GFF_{A1,AB}^{RAS}) + \text{G2 Energy Award} \cdot (GFF_{A2,AB}^{RAS}) + \text{G3 Energy Award} \cdot (GFF_{B,AB}^{RAS}) \\ 750 \text{ MW} &= 500 \cdot (0.033742) + 733 \cdot (1) + 767 \cdot (0) \end{aligned}$$

Remedial action scheme preventive case flows of 750 MW are less than or equal to the emergency transfer capability on the path, given the remedial action scheme operation, and the constraint binds at a shadow cost ( $\mu^{RAS}_{AB}$ ) of \$15.

### Price Formation

Generator G1 is charged for its contribution to the congestion from A to B. In this example, it is charged for the portion of its output that was distributed to bus A using the pro-rata distribution (the impact of the distributed generation is represented as the generator flow factor  $GFF^{RAS}_{A1,AB}$ ). Because node A1 has a network topology shift factor of 1 ( $SF^{g_{A1,AB}}$ ) to the constraint, all of the portion of energy distributed to bus A (G1 Energy Award ( $GFF^{RAS}_{A1,AB} \cong 17 \text{ MW}$ )) is charged  $\mu^{RAS}_{AB}$  in congestion.

Generator G2 is charged the \$15 in congestion from A to B because its full output has a network topology shift factor of 1 ( $SF^{g_{A2,AB}}$ ) to the constraint in the remedial action scheme preventive constraint. G1 is charged approximately the same amount in congestion as any other generator that is not contributing to the congestion (G1 and G3 are charged ~\$0 in congestion from A to B), while G2 which contributes its full output to the remedial action scheme preventive case congestion is charged \$15.

Generator (i)	$\lambda^0$	Normal		Loss of G1+T2		LMP
		$SF^0_{i,AB}$	$\mu^0_{AB}$	$GFF^{RAS}_{i,AB}$	$\mu^{RAS}_{AB}$	
G1	\$50	1	\$0	0.033742	\$15	\$49.49
G2	\$50	1	\$0	1	\$15	\$35
G3	\$50	0	\$0	0	\$15	\$50

### Settlement

Generator/ Load	LMP	Energy Award	Energy Payment	Total Revenue
G1	\$49.49	500	\$24,745	\$24,745
G2	\$35	733	\$25,655	\$25,655
G3	\$50	767	\$38,350	\$38,350
Load B	\$50	-2000	-\$100,000	-\$100,000
Energy & Capacity				-\$11,250
CRR <sub>AB</sub>	\$15	750		\$11,250
Market Net				\$0

### L.4.1.3 Example 3 (both normal and emergency limit bind)

In this example, we show the normal limit binding and the remedial action scheme preventive constraint binding, thereby showing that the remedial action scheme generator that still contributes to base case congestion is charged for base case congestion. However, because it is minimally contributing to preventive case congestion, it is minimally charged for that congestion.

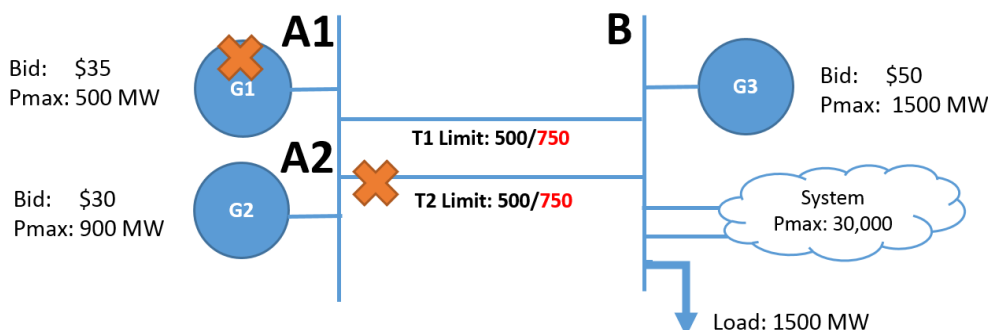

As shown using orange X's above, a remedial action scheme is defined such that if transmission line T2 is lost, generator G1 will be tripped offline. The total normal transfer limit from A to B is 1,000 MW (500 MW on T1 plus 500 MW on T2). The total emergency transfer limit from A to B is 1,500 MW (750 MW on T1 plus 750 MW on T2); however, given the simultaneous preventive loss of T2 and G1, an emergency transfer limit between A and B of 750 MW will be enforced.

#### Bids & Awards

Generators G1, G2, and G3 submit the following bids and receive the following energy awards given the enhanced market dispatch.

Generator	Energy Bid	Energy Award	LMP
G1	\$35	257	\$35
G2	\$30	743	\$30
G3	\$50	500	\$50

The market dispatches 743 MW of the cheapest energy from G2. The RAS preventive constraint transfer limit from A to B of 750 MW binds, and the market dispatches 257 MW of the next cheapest generation from G1. The base case normal transfer limit between A and B of 1000 MW binds, and the market dispatches the remaining 500 MW necessary to serve 1,500 MW of load from G3.

1,000 MW flows from A to B in the base case, and 750 MW flows from A to B in the remedial action scheme preventive case. Note that the remedial action scheme preventive constraint binds at 750 MW because a full 750 MW would flow from A to B after the loss of T2 and remedial action scheme operation that removes G1 from service; all of which is modeled as being produced from bus A.

### Modeled Flows

1,000 MW flow from A to B in the base case, and 750 MW flow from A to B in the remedial action scheme preventive case. Note that the remedial action scheme preventive constraint binds at 750 MW because a full 750 MW would flow from A to B after the loss of T2 and remedial action scheme operation that removes G1 from service; all of which is modeled as being produced from bus A.

Base case flows from A to B are calculated:

$$\begin{aligned} \text{Flow}_{AB}^0 &= \text{G1 Energy Award} \cdot (\text{SF}_{A1,AB}^0) + \text{G2 Energy Award} \cdot (\text{SF}_{A2,AB}^0) + \text{G3 Energy Award} \cdot (\text{SF}_{B,AB}^0) \\ 1,000 \text{ MW} &= 257 \cdot (1) + 743 \cdot (1) + 500 \cdot (0) \end{aligned}$$

Base case flows of 1,000 MW are less than or equal to the normal transfer capability on the path and the constraint binds at a shadow cost ( $\mu_{AB}^0$ ) of \$15.

As discussed in Section **Error! Reference source not found.**, the system's response to G1's lost generation is distributed to each node on the system pro-rata based on each node's cumulative Pmax. Generator G1's contribution to flows on the path from A to B and consequently its contribution to this constraint's cost is calculated as:

$$\begin{aligned} GFF_{A1,AB}^{RAS} &= \sum_{\substack{i=1 \\ i \neq o_g}}^N SF_{i,m}^g GDF_{o_g,i} = \sum_{\substack{i=1 \\ i \neq o_g}}^N SF_{i,m}^g \frac{G_{i,max}}{\sum_{i \neq o_g} G_{i,max}} \\ &= (1) \cdot \frac{900}{32,400} + (0) \cdot \frac{1,500}{32,400} + (0) \cdot \frac{30,000}{32,400} = 0.027778 \end{aligned}$$

Remedial action scheme preventive case flows from A to B are calculated:

$$\begin{aligned} \text{Flow}_{AB}^{RAS} &= \text{G1 Energy Award} \cdot (\text{GFF}_{A1,AB}^{RAS}) + \text{G2 Energy Award} \cdot (\text{GFF}_{A2,AB}^{RAS}) + \text{G3 Energy Award} \cdot (\text{GFF}_{B,AB}^{RAS}) \\ 750 \text{ MW} &= 257 \cdot (0.027778) + 743 \cdot (1) + 500 \cdot (0) \end{aligned}$$

Remedial action scheme preventive case flows of 750 MW are less than or equal to the emergency transfer capability on the path, given the remedial action scheme operation, and the constraint binds at a shadow cost ( $\mu_{AB}^{RAS}$ ) of \$5.

### Price Formation

Because both G1 and G2 contribute to the normal limit congestion, they are charged \$15 in congestion from A to B. G2 additionally contributes to the remedial action scheme preventive constraint congestion, and is therefore charged an additional \$5 in congestion from A to B. G1 is charged a total of \$15 in congestion while G2 is charged a total of \$20 in congestion from A to B. G3 does not contribute to congestion from A to B, so it does not receive a congestion charge.

Generator G1 is charged for its contribution to the congestion from A to B mostly due to the normal constraint, but also minimally due to the remedial action scheme preventive constraint. Generator G1's full output is charged  $\mu^{0}_{AB}$  due to its contribution to the binding normal limit. It is also charged the congestion related to the remedial action scheme preventive constraint ( $\mu^{RAS}_{AB}$ ) for the portion of its output that was distributed to bus A using the pro-rata distribution (the impact of the distributed generation is represented as the generator flow factor  $GFF^{RAS}_{A1,AB}$ ). Because bus A has a network topology shift factor of 1 ( $SF^{g_{A1,AB}}$ ) to the constraint, all of the portion of energy distributed to bus A (G1 Energy Award  $\cdot (GFF^{RAS}_{A1,AB}) \cong 7$  MW) is charged  $\mu^{RAS}_{AB}$  in congestion.

Generator G2 is charged a total of \$20 for its contribution to the congestion from A to B due to the normal constraint ( $\mu^{0}_{AB}=\$15$ ) and the remedial action scheme preventive constraint ( $\mu^{RAS}_{AB}=\$5$ ). Generator G2's full output is charged  $\mu^{0}_{AB}$  due to its contribution to the binding normal limit. Generator G2 is also charged  $\mu^{RAS}_{AB}$  in congestion from A to B because its full output has a contribution factor of 1 ( $GFF^{g_{A2,AB}}$ ) to the constraint in the remedial action scheme preventive constraint.

Generator G1 is charged for its total contribution to congestion, mostly through its contribution to the normal constraint, but also minimally due to the remedial action scheme preventive constraint. Generator G2 is charged for its total contribution to congestion through both the normal constraint and the remedial action scheme preventive constraint.

Generator (i)	$\lambda^0$	Normal		Loss of G1+T2		LMP
		$SF^0_{i,AB}$	$\mu^0_{AB}$	$GFF^{RAS}_{i,AB}$	$\mu^{RAS}_{AB}$	
G1	\$50	1	\$15	0.027778	\$5	\$35
G2	\$50	1	\$15	1	\$5	\$30
G3	\$50	0	\$15	0	\$5	\$50

**Settlement**

<b>Generator/ Load</b>	<b>LMP</b>	<b>Energy Award</b>	<b>Energy Payment</b>	<b>Total Revenue</b>
<b>G1</b>	\$35	257	\$8,995	\$8,995
<b>G2</b>	\$30	743	\$22,290	\$22,290
<b>G3</b>	\$50	500	\$25,000	\$25,000
<b>Load B</b>	\$50	-1500	-\$75,000	-\$75,000
<b>Energy &amp; Capacity</b>				-\$18,715
<b>CRR<sub>AB</sub></b>	\$20	750		\$15,000
<b>Market Net</b>				-\$3,715

## L.3.1 Secure transmission after generator loss

### L.3.1.1 Example 1 (Emergency limit binds for loss of generation)

In this example, we show the emergency limit binding for the loss of a generator. Here, we examine the interplay between today's transmission constraints and the proposed generator contingency constraints. This example shows that the loss of generation modeled as proposed may be more limiting than the loss of transmission in an area of the system by enforcing both types of contingencies in the market.

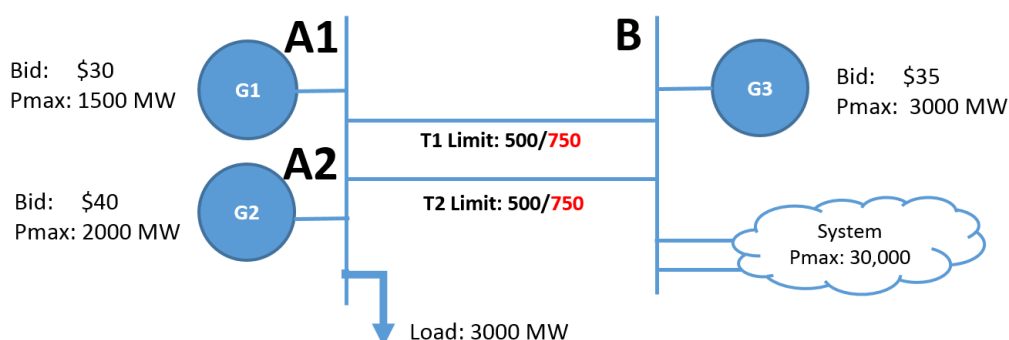

The total normal transfer limit from B to A is 1,000 MW (500 MW on T1 plus 500 MW on T2). The total emergency transfer limit from B to A is 1,500 MW (750 MW on T1 plus 750 MW on T2); however, given the preventive loss of T1, an emergency transfer limit from B to A of 750 MW will be enforced. We also enforce a generator contingency preventive constraint to protect the path from B to A for the potential loss of each generator (G1, G2, and G3); this constraint has a total emergency transfer limit of 1,500 MW (750 MW on T1 plus 750 MW on T2).

#### Bids & Awards

Generators G1, G2, and G3 submit the following bids and receive the following energy awards given the enhanced market dispatch.

Generator	Energy Bid	Energy Award	LMP
G1	\$30	1500	\$35.29
G2	\$40	1414	\$40
G3	\$35	86	\$35

The market dispatches the cheapest energy on G1 up to its Pmax of 1,500 MW followed by the next cheapest energy from G3. To protect for the loss of G1, the generator contingency preventive constraint transfer limit from B to A of 1,500 MW binds, and the market dispatches G2 for the remaining 1,414 MW necessary to serve 3,000 MW of load.



### Modeled Flows

**Base case.** 86 MW flow from B to A in the base case. Base case flows from B to A are calculated:

$$\begin{aligned} \text{Flow}^{0_{BA}} &= \text{G1 Energy Award} \cdot (\text{SF}^{0_{A1,BA}}) + \text{G2 Energy Award} \cdot (\text{SF}^{0_{A2,BA}}) + \text{G3 Energy Award} \cdot (\text{SF}^{0_{B,BA}}) \\ 86 \text{ MW} &= 1500 \cdot (0) + 1414 \cdot (0) + 86 \cdot (1) \end{aligned}$$

Base case flows of 86 MW are less than the normal transfer capability of 1,000 MW on the path and the normal constraint does not bind.

**Transmission line T1 contingency.** 86 MW flow from B to A in the preventive case protecting for the loss of T1. Flows are calculated:

$$\begin{aligned} \text{Flow}^{T1_{BA}} &= \text{G1 Energy Award} \cdot (\text{SF}^{T1_{A1,BA}}) + \text{G2 Energy Award} \cdot (\text{SF}^{T1_{A2,BA}}) + \text{G3 Energy Award} \cdot (\text{SF}^{T1_{B,BA}}) \\ 86 \text{ MW} &= 1500 \cdot (0) + 1414 \cdot (0) + 86 \cdot (1) \end{aligned}$$

Preventive case flows of 86 MW are less than the emergency rating on the path and the constraint does not bind.

**Generator G1 contingency.** 1,500 MW flow from B to A in the generator contingency preventive case protecting for the loss of G1. Flows are calculated:

$$\begin{aligned} \text{Flow}^{G1_{BA}} &= \text{G1 Energy Award} \cdot (\text{GFF}^{G1_{A1,BA}}) + \text{G2 Energy Award} \cdot (\text{GFF}^{G1_{A2,BA}}) + \text{G3 Energy Award} \cdot (\text{GFF}^{G1_{B,BA}}) \\ 1,500 \text{ MW} &= 1500 \cdot (0.942857) + 1414 \cdot (0) + 86 \cdot (1) \end{aligned}$$

As discussed in Section **Error! Reference source not found.**, the system's response to G1's lost generation is distributed to each node on the system pro-rata based on each node's cumulative Pmax. Generator G1's contribution to flows on the path from B to A and consequently its contribution to this constraint's cost is calculated as:

$$\begin{aligned} \text{GFF}_{A1,BA}^{G1} &= \sum_{\substack{i=1 \\ i \neq o_g}}^N \text{SF}_{i,m}^g \text{GDF}_{o_g,i} = \sum_{\substack{i=1 \\ i \neq o_g}}^N \text{SF}_{i,m}^g \frac{G_{i,max}}{\sum_{i \neq o_g} G_{i,max}} \\ &= (0) \cdot \frac{2,000}{35,000} + (1) \cdot \frac{3,000}{35,000} + (1) \cdot \frac{30,000}{35,000} = 0.942857 \end{aligned}$$

The other GFF's are equal to the network topology shift factors.

Generator contingency preventive case flows of 1,500 MW are less than or equal to the emergency rating on the path and the constraint binds at a shadow cost ( $\mu^{G1_{BA}}$ ) of \$5.

**Generator G2 contingency.** 1,439 MW flow from B to A in the generator contingency preventive case protecting for the loss of G2. Flows are calculated:

$$\text{Flow}^{G2_{BA}} = \text{G1 Energy Award} \cdot (\text{GFF}^{G2_{A1,BA}}) + \text{G2 Energy Award} \cdot (\text{GFF}^{G2_{A2,BA}}) + \text{G3 Energy Award} \cdot (\text{GFF}^{G2_{B,BA}})$$

$$1,439 \text{ MW} = 1500 \cdot (0) + 1414 \cdot (0.956522) + 86 \cdot (1)$$

As shown in the formulation section above, the system's response to G2's lost generation is distributed to each node on the system pro-rata based on each node's cumulative Pmax. Generator G2's contribution to flows on the path from B to A and consequently its contribution to this constraint's cost is calculated as:

$$\begin{aligned} \text{GFF}_{A2,BA}^{G2} &= \sum_{\substack{i=1 \\ i \neq o_g}}^N \text{SF}_{i,m}^g \text{GDF}_{o_g,i} = \sum_{\substack{i=1 \\ i \neq o_g}}^N \text{SF}_{i,m}^g \frac{G_{i,max}}{\sum_{i \neq o_g} G_{i,max}} \\ &= (0) \cdot \frac{1500}{34,500} + (1) \cdot \frac{3,000}{34,500} + (1) \cdot \frac{30,000}{34,500} = 0.956522 \end{aligned}$$

The other GFF's are equal to the network topology shift factors.

Generator contingency preventive case flows of 1,439 MW are less than the emergency rating on the path and the constraint does not bind.

**Generator G3 contingency.** 77 MW flow from B to A in the generator contingency preventive case protecting for the loss of G3. Flows are calculated:

$$\text{Flow}^{G3_{BA}} = \text{G1 Energy Award} \cdot (\text{GFF}^{G3_{A1,BA}}) + \text{G2 Energy Award} \cdot (\text{GFF}^{G3_{A2,BA}}) + \text{G3 Energy Award} \cdot (\text{GFF}^{G3_{B,BA}})$$

$$77 \text{ MW} = 1500 \cdot (0) + 1414 \cdot (0) + 86 \cdot (0.895522)$$

As shown in the formulation section above, the system's response to G3's lost generation is distributed to each node on the system pro-rata based on each node's cumulative Pmax. Generator G3's contribution to flows on the path from B to A and consequently its contribution to this constraint's cost is calculated as:

$$\begin{aligned} \text{GFF}_{B,BA}^{G3} &= \sum_{\substack{i=1 \\ i \neq o_g}}^N \text{SF}_{i,m}^g \text{GDF}_{o_g,i} = \sum_{\substack{i=1 \\ i \neq o_g}}^N \text{SF}_{i,m}^g \frac{G_{i,max}}{\sum_{i \neq o_g} G_{i,max}} \\ &= (0) \cdot \frac{1500}{33,500} + (0) \cdot \frac{2,000}{33,500} + (1) \cdot \frac{30,000}{33,500} = 0.895522 \end{aligned}$$

The other GFF's are equal to the network topology shift factors.

Generator contingency preventive case flows of 77 MW are less than the emergency rating on the path and the constraint does not bind.

### Price Formation

Generator G1 is charged for its contribution to the congestion from B to A. In this example, it is charged for the portion of its output that was distributed to bus B using the pro-rata distribution. Because node B has a network topology shift factor of 1 ( $SF^{G1_{B,BA}}$ ) to the constraint, all of the portion of energy distributed to bus B (G1 Energy Award  $\cdot (GFF^{G1_{A1,BA}}) \cong 1414$  MW) is charged  $\mu^{G1_{BA}}$  in congestion.

Generator G3 is charged for its contribution to the congestion from B to A because it has a contribution factor of 1 ( $GFF^{G3_{B,BA}}$ ) to the path for the transmission preventive constraint that binds at a shadow cost ( $\mu^{G1_{BA}}$ ) of \$5.

For generators G2 and G3, the generator flow factors representing the impact on the path of the portions of their output distributed to the various buses in the system were calculated ( $GFF^{G2_{A2,BA}}$  and  $GFF^{G3_{B,BA}}$ ) but not used because the constraints did not bind.

Generator (i)	$\lambda^0$	Normal		Loss of T1		Loss of G1		Loss of G2		Loss of G3		LMP
		$SF^{0_{i,BA}}$	$\mu^{0_{BA}}$	$SF^{T1_{i,BA}}$	$\mu^{T1_{BA}}$	$GFF^{G1_{i,BA}}$	$\mu^{G1_{BA}}$	$GFF^{G2_{i,BA}}$	$\mu^{G2_{BA}}$	$GFF^{G3_{i,BA}}$	$\mu^{G3_{BA}}$	
<b>G1</b>	\$40	0	\$0	0	\$0	0.942857	\$5	0	\$0	0	\$0	\$35.29
<b>G2</b>	\$40	0	\$0	0	\$0	0	\$5	0.956522	\$0	0	\$0	\$40
<b>G3</b>	\$40	1	\$0	1	\$0	1	\$5	1	\$0	0.895522	\$0	\$35

### Settlement

Generator/ Load	LMP	Energy Award	Energy Payment	Total Revenue
<b>G1</b>	\$35.29	1500	\$52,935	\$52,935
<b>G2</b>	\$40	1414	\$56,560	\$56,560
<b>G3</b>	\$35	86	\$3,010	\$3,010
<b>Load A</b>	\$40	-3000	-\$120,000	-\$120,000
<b>Energy &amp; Capacity</b>				-\$7,495
<b>CRR<sub>BA</sub></b>	\$5	750		\$3,750
<b>Market Net</b>				-\$3,745

### L.3.1.2 Example 2 (Emergency limit binds for loss of transmission)

In this example, we show the emergency limit binding only for the loss of a transmission line even though we enforce a generator contingency for all three generators. Here, we examine the interplay between today's transmission constraints and the proposed generator contingency constraints. This example shows that the loss of transmission, as modeled today, may be more limiting than the loss of generation in an area of the system by enforcing both types of contingencies in the market.

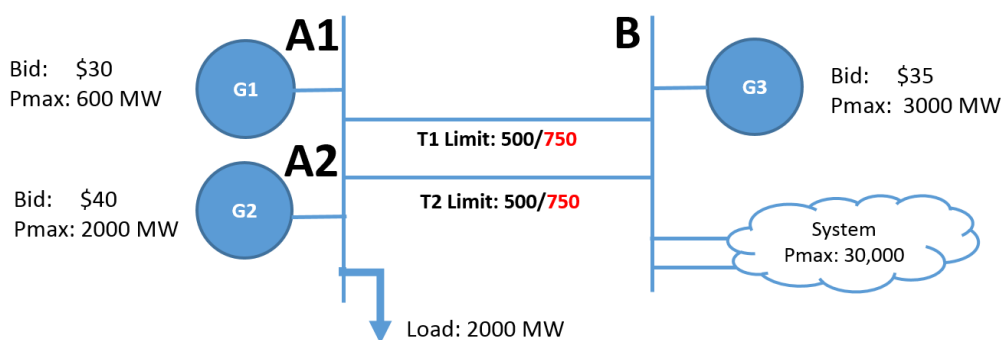

The total normal transfer limit from B to A is 1,000 MW (500 MW on T1 plus 500 MW on T2). The total emergency transfer limit from B to A is 1,500 MW (750 MW on T1 plus 750 MW on T2); however, given the preventive loss of T1, an emergency transfer limit from B to A of 750 MW will be enforced. We also enforce a generator contingency preventive constraint to protect the path from B to A for the potential loss of each generator (G1, G2, and G3); this constraint has a total emergency transfer limit of 1,500 MW (750 MW on T1 plus 750 MW on T2).

#### Bids & Awards

Generators G1, G2, and G3 submit the following bids and receive the following energy awards given the enhanced market dispatch.

Generator	Energy Bid	Energy Award	LMP
G1	\$30	600	\$40
G2	\$40	650	\$40
G3	\$35	750	\$35

The market dispatches the cheapest energy on G1 up to its Pmax of 600 MW followed by the next cheapest energy from G3. To protect for the loss of T1, the preventive constraint transfer limit from B to A of 750 MW binds, and the market dispatches G2 for the remaining 650 MW necessary to serve 2,000 MW of load.

### Modeled Flows

**Base case.** 750 MW flow from B to A in the base case. Base case flows from B to A are calculated:

$$\text{Flow}_{BA}^0 = \text{G1 Energy Award} \cdot (\text{SF}_{A1,BA}^0) + \text{G2 Energy Award} \cdot (\text{SF}_{A2,BA}^0) + \text{G3 Energy Award} \cdot (\text{SF}_{B,BA}^0)$$

$$750 \text{ MW} = 600 \cdot (0) + 650 \cdot (0) + 750 \cdot (1)$$

Base case flows of 750 MW are less than or equal to the normal transfer capability of 1,000 MW on the path and the normal constraint does not bind.

**Transmission line T1 contingency.** 750 MW flow from B to A in the preventive case protecting for the loss of T1. Flows are calculated:

$$\text{Flow}_{BA}^{T1} = \text{G1 Energy Award} \cdot (\text{SF}_{A1,BA}^{T1}) + \text{G2 Energy Award} \cdot (\text{SF}_{A2,BA}^{T1}) + \text{G3 Energy Award} \cdot (\text{SF}_{B,BA}^{T1})$$

$$750 \text{ MW} = 600 \cdot (0) + 650 \cdot (0) + 750 \cdot (1)$$

Preventive case flows of 750 MW are less than or equal to the emergency rating on the path and the constraint binds at a shadow cost ( $\mu^{T1_{AB}}$ ) of \$5.

**Generator G1 contingency.** 1,316 MW flow from B to A in the generator contingency preventive case protecting for the loss of G1. Flows are calculated:

$$\text{Flow}_{BA}^{G1} = \text{G1 Energy Award} \cdot (\text{GFF}_{A1,BA}^{G1}) + \text{G2 Energy Award} \cdot (\text{GFF}_{A2,BA}^{G1}) + \text{G3 Energy Award} \cdot (\text{GFF}_{B,BA}^{G1})$$

$$1,316 \text{ MW} = 600 \cdot (0.942857) + 650 \cdot (0) + 750 \cdot (1)$$

As discussed in Section **Error! Reference source not found.**, the system's response to G1's lost generation is distributed to each node on the system pro-rata based on each node's cumulative Pmax. Generator G1's contribution to flows on the path from B to A and consequently its contribution to this constraint's cost is calculated as:

$$\text{GFF}_{A1,BA}^{G1} = \sum_{\substack{i=1 \\ i \neq o_g}}^N \text{SF}_{i,m}^g \text{GDF}_{o_g,i} = \sum_{\substack{i=1 \\ i \neq o_g}}^N \text{SF}_{i,m}^g \frac{G_{i,max}}{\sum_{i \neq o_g} G_{i,max}}$$

$$= (0) \cdot \frac{2000}{35,000} + (1) \cdot \frac{3,000}{35,000} + (1) \cdot \frac{30,000}{35,000} = 0.942857$$

The other GFF's are equal to the network topology shift factors.

Generator contingency preventive case flows of 1,316 MW are less than the emergency rating on the path and the constraint does not bind.

**Generator G2 contingency.** 1,388 MW flow from B to A in the generator contingency preventive case protecting for the loss of G2. Flows are calculated:

$$\text{Flow}^{G2_{BA}} = \text{G1 Energy Award} \cdot (\text{GFF}^{G2_{A1,BA}}) + \text{G2 Energy Award} \cdot (\text{GFF}^{G2_{A2,BA}}) + \text{G3 Energy Award} \cdot (\text{GFF}^{G2_{B,BA}})$$

$$1,388 \text{ MW} = 600 \cdot (0) + 650 \cdot (0.98214) + 750 \cdot (1)$$

As discussed in Section **Error! Reference source not found.**, the system's response to G2's lost generation is distributed to each node on the system pro-rata based on each node's cumulative Pmax. Generator G2's contribution to flows on the path from B to A and consequently its contribution to this constraint's cost is calculated as:

$$\text{GFF}_{A2,BA}^{G2} = \sum_{\substack{i=1 \\ i \neq o_g}}^N \text{SF}_{i,m}^g \text{GDF}_{o_g,i} = \sum_{\substack{i=1 \\ i \neq o_g}}^N \text{SF}_{i,m}^g \frac{G_{i,max}}{\sum_{i \neq o_g} G_{i,max}}$$

$$= (0) \cdot \frac{600}{33,600} + (1) \cdot \frac{3,000}{33,600} + (1) \cdot \frac{30,000}{33,600} = 0.98214$$

The other GFF's are equal to the network topology shift factors.

Generator contingency preventive case flows of 1,388 MW are less than the emergency rating on the path and the constraint does not bind.

**Generator G3 contingency.** 690 MW flow from B to A in the generator contingency preventive case protecting for the loss of G3. Flows are calculated:

$$\text{Flow}^{G3_{BA}} = \text{G1 Energy Award} \cdot (\text{GFF}^{G3_{A1,BA}}) + \text{G2 Energy Award} \cdot (\text{GFF}^{G3_{A2,BA}}) + \text{G3 Energy Award} \cdot (\text{GFF}^{G3_{B,BA}})$$

$$690 \text{ MW} = 600 \cdot (0) + 650 \cdot (0) + 750 \cdot (0.92025)$$

As discussed in Section **Error! Reference source not found.**, the system's response to G3's lost generation is distributed to each node on the system pro-rata based on each node's cumulative Pmax. Generator G3's contribution to flows on the path from B to A and consequently its contribution to this constraint's cost is calculated as:

$$\text{GFF}_{B,BA}^{G3} = \sum_{\substack{i=1 \\ i \neq o_g}}^N \text{SF}_{i,m}^g \text{GDF}_{o_g,i} = \sum_{\substack{i=1 \\ i \neq o_g}}^N \text{SF}_{i,m}^g \frac{G_{i,max}}{\sum_{i \neq o_g} G_{i,max}}$$

$$= (0) \cdot \frac{600}{32,600} + (0) \cdot \frac{2,000}{32,600} + (1) \cdot \frac{30,000}{32,600} = 0.92025$$

The other GFF's are equal to the network topology shift factors.

Generator contingency preventive case flows of 690 MW are less than the emergency rating on the path and the constraint does not bind.

### Price Formation

Generator G3 is charged for its contribution to the congestion from B to A because it has a shift factor of 1 ( $SF^{T1}_{B,BA}$ ) to the path for the transmission preventive constraint that binds at a shadow cost ( $\mu^{T1}_{AB}$ ) of \$5.

For all generators in generator contingencies, while the generator flow factors representing the impact of the portions of their output of which were distributed to the various buses in the system were calculated ( $GFF^{G1}_{i,BA}$ ,  $GFF^{G2}_{i,BA}$ , and  $GFF^{G3}_{i,BA}$ ) the constraints did not bind.

Generator (i)	$\lambda^0$	Normal		Loss of T1		Loss of G1		Loss of G2		Loss of G3		LMP
		$SF^{0}_{i,BA}$	$\mu^{0}_{BA}$	$SF^{T1}_{i,BA}$	$\mu^{T1}_{BA}$	$GFF^{G1}_{i,BA}$	$\mu^{G1}_{BA}$	$GFF^{G2}_{i,BA}$	$\mu^{G2}_{BA}$	$GFF^{G3}_{i,BA}$	$\mu^{G3}_{BA}$	
G1	\$40	0	\$0	0	\$5	0.942857	\$0	0	\$0	0	\$0	\$40
G2	\$40	0	\$0	0	\$5	0	\$0	0.98214	\$0	0	\$0	\$40
G3	\$40	1	\$0	1	\$5	1	\$0	1	\$0	0.92025	\$0	\$35

### Settlement

Generator/ Load	LMP	Energy Award	Energy Payment	Total Revenue
G1	\$40	600	\$24,000	\$24,000
G2	\$40	650	\$26,000	\$26,000
G3	\$35	750	\$26,250	\$26,250
Load A	\$40	-2000	-\$80,000	-\$80,000
Energy & Capacity				-\$3,750
CRR <sub>BA</sub>	\$5	750		\$3,750
Market Net				\$0

# **Attachment M**

## **Imbalance Conformance**



---

## M. Imbalance Conformance

### M.1 Load Forecast Conformance Logic

System operators in the CAISO and all EIM balancing authority areas are responsible for continually maintaining a balance of supply and demand to maintain system reliability. Frequency deviations can result when the system is not balanced (i.e., energy generated does not equal energy consumed), making it difficult for the CAISO and EIM balancing authority areas to comply with NERC Reliability Standard BAL-001-2 Real Power Balancing Control Performance, which applies to all balancing authorities. System operators will conform the load forecast in order to maintain system balance.

The need to conform may be due to operating system conditions such as load forecast inaccuracies, variable energy resource (VER) deviation, real-time contingencies, pump schedule deviation from day-ahead market, generator testing. System operators must take manual actions to respond to these system conditions and ensure the system is balanced, and in compliance with NERC reliability requirements. System operators can correct these factors before the market run by making conformances to the load forecast (i.e., conform the load forecast). System operators will conform the CAISO Forecast of CAISO Demand (i.e., the load forecast for the CAISO balancing authority area) when possible to inform the market to move the system in the desired direction to maintain system balance. System operators will aim to move the system in the desired direction as soon as possible and reasonable so the system can commit, decommit, or keep resources on line as early as possible. By using the market solution, system operators avoid creating constraints or risking situations that may violate NERC reliability criteria.

System operators may conform the load forecast conformance independently for each market run (i.e., for the RTD, RTPD, and STUC separately or for all) by utilizing a load forecast tool that allows the operator to conform the load forecast by using an aggregated value to correct for various system changes in an expedited manner. Load forecast conformance is necessary to balance the continually changing system conditions and the load forecast provides a quick and effective tool to maintain reliability.

Below is a list of the type of factors that may cause the system operator to conform the load forecast. The list is not exhaustive because the system operators may have to conform for a particular system condition the CAISO has not experienced before but may also affect the reliable operations of the system.

- Load forecast error – System operators may observe conditions that differ from the load forecast, thus necessitating load forecast conformance.
- System balance adjustments – System operators must ensure system balance is within NERC criteria. The market systems do not always directly recognize deviations of area control errors that must be addressed in order to comply with NERC Standard-BAL 001-2.7 Therefore, the system operator may conform the load forecast to ensure the market systems produce a market solution that helps control system balance.
- Variable energy resources deviations – Although the CAISO uses reliable forecasts to dispatch variable energy resources, such resources may deviate from their dispatches and forecasts due to reasons such as forecast errors. Significant and persistent deviations may require a system operator to conform the load forecast so the market solution can account for such deviations.

- Resource outages or transmission or equipment outages not entered into the outage management system – System operators may observe certain generator or transmission equipment outages that were not entered into the outage management system, but affect bids scheduling coordinators submitted. This may arise because outages occur after the bid submission timeline. Therefore, the market system expects these resources to be available and, without a load conformance, the market system will not redispatch other resources to accommodate their unavailability, thus producing an inaccurate dispatch that could adversely affect system conditions. For example, the system operator could conform the load forecast to account for the lack of generation the system would otherwise expect to be available.
- Generator testing – System operators may test generators prior to the generator becoming fully connected and operational. The system operator may need to conform the load forecast to accommodate the presence of test energy to ensure the market systems produce a reliable solution.
- Weather Changes – The load forecast may fail to capture rapid weather changes, which can result in the market systems producing an infeasible and unreliably market solution. Operator conformances to the load forecast can steer the market outcome to meet those otherwise unknown system conditions and requirements.
- Pumping resource schedule change – The CAISO real-time market assumes that specific pump-storage hydro resources will follow their day-ahead market schedules. If the pump-storage resource does not follow the day-ahead schedule, the system operator will conform the load to ensure the real-time market is aware of the schedule change.

## M.2 Conformance Limiter

The load conformance limiter tool is an automated functionality that ensures the system operator-initiated conformances to load forecasts that enter the market optimization do not exceed the actual market ramping capability and are consistent with actual system needs. The limiter assumes that if the system operator had been aware of the available ramping capability, the system operator would have refined the conformances to rely only on the amount of ramping capability necessary to meet the actual system conditions over a period. The magnitude nature of the conformance is a product of the system operator's best estimate of system needs. The system operator may need to apply the conformance over multiple intervals because it is not possible for the system operator to apply the conformance with more precision and ramp the system up to where it needs to be in each interval to achieve the overall goal of balancing the system within NERC reliability requirements. These are what the CAISO refers to as "coarse adjustments." The limiter ensures the coarse adjustments do not cause a power balance constraint violation in a given interval in which the coarse adjustment exceeds the ramping capability, but the supply is not needed in that interval.

Although, system operators do not consider whether their actions affect prices, conforming the load forecast either increases or decreases demand, which will affect the prices and

quantities cleared in the real-time market. This is both true when there are sufficient effective bids to clear supply bids against the demand forecast and export bids in the real-time market. When this is not the case, the market must relax a balancing authority area's power balance constraint in order to clear the market. When the market clears without relaxing a power balance constraint, the system marginal energy cost component of locational marginal prices is set by the economic bid of the marginal resource. However, when the market must relax a power balance constraint to derive a feasible solution, the system marginal energy cost is set at the \$1,000 per MWh power balance relaxation parameter that is specified in Section 27.4.3.4 of the CAISO tariff, which is pegged to the maximum energy bid in price. The CAISO enforces a power balance constraint for each of the balancing authority areas in the EIM, including the CAISO's, and one that applies for the aggregated balancing authority areas.

The conformance limiter logic will trigger when the following conditions exist for the applicable interval:

- The limiter is based on the conformance and infeasibility changes between intervals,
- The limiter is not limited to information from the current interval,
- The limiter is not subject to the infeasibility and the conformance being in the same direction, and
- The limiter will consider the conformance magnitudes in previous intervals and whether the limiter was applied in the corresponding intervals.

The following equations explain the logic of the conformance limiter;

The limiter will solve for  $C_i$ . The limiter will trigger for under-generation, as indicated by a positive infeasibility, when the value of  $C_i$  is less than 0:

$$C_i = (PBC\_infi - PBC\_infi-1) - (Confi - Confi-1) + \text{Max}(0, Ci-1)$$

If  $C_i < 0$ , limiter triggers.

If  $C_i > 0$ , limiter does not trigger.

The limiter will solve for  $C_i$ . The limiter will trigger for over-generation, as indicated by a negative infeasibility, when the value of  $C_i$  is greater than 0:

$$C_i = (PBC\_infi - PBC\_infi-1) - (Confi - Confi-1) + \text{Min}(0, Ci-1)$$

If  $C_i < 0$ , limiter does not trigger.

If  $C_i > 0$ , limiter triggers.

Where:

$i$	Index for current interval
$(i-1)$	Previous interval <sup>11</sup>
$C_i$	Remaining available capability to absorb power balance constraint infeasibilities in the current interval (i.e., the system's ramping capability)
$(PBC\_infi - PBC\_infi-1)$	Change of power balance constraint infeasibility between current and previous intervals
$(Confi - Confi-1)$	Change of load conformance between current and previous intervals
$\text{Max}(0, C_{i-1})$	Carry-over from previous market interval in shortfall of available capability to absorb power balance constraint infeasibility that was not due to load conformance.
$\text{Min}(0, C_{i-1})$	Carry-over capability from previous interval.

If in any given interval the power balance constraint infeasibility results in a value of 0,  $C_i$  is reset to 0.

Examples:

Examples 1–3 describe the conformance limiter logic and functionality.

---

<sup>11</sup> For the Fifteen-Minute Market, the previous interval denoted as  $(i-1)$  is not the binding interval of the previous FMM run,  $(i-1)$  is the first interval of the Real-Time Unit Commitment (RTUC) time horizon, as indicated by "C1" in Exhibit 7-1 of the BPM for Market Operations. In the fifteen minute market, the second interval in the horizon is actually the financially binding interval, while the first interval is identified as a buffer.

Example 1:

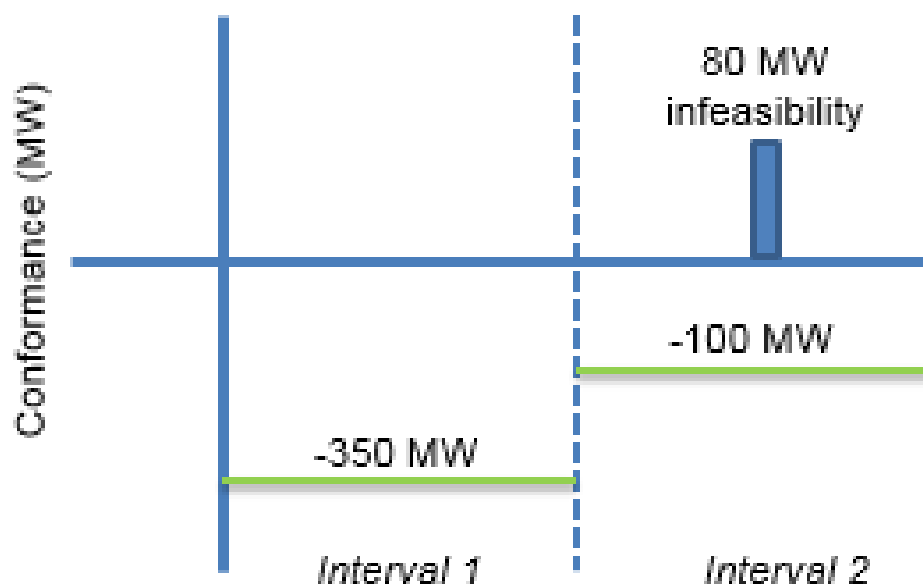

For under-generation and starting with  $C_0 = 0$ ,  $C_1$  is calculated as follows:

$$C_i = (PBC\_infi - PBC\_infi-1) - (Confi - Confi-1) + \max(0, C_{i-1})$$

$$C_1 = (80 - 0) - (-100 - (-350)) + \max(0, 0) = -170$$

$C_1 = -170 < 0$ ? Yes, therefore the limiter applies.

Since  $C_1$  is less than zero, the conformance limiter applies. The change in the system operator conformance between intervals 1 and 2 is larger than the ramping capability on the system and the limiter should trigger. Therefore, even if the conformance and the infeasibility are in different directions, the new limiter will trigger. This ensures is because the limiter recognizes the changes between intervals instead of relying solely on information from one independent intervals.

Example 2:

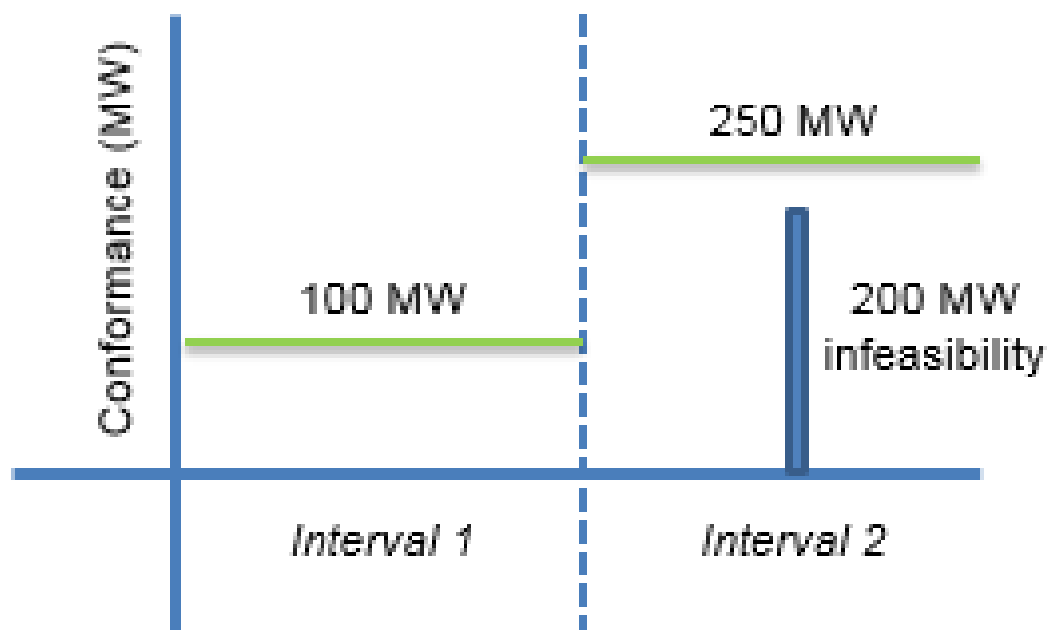

For under-generation and starting with  $C_0 = 0$ ,  $C_1$  is calculated as follows:

$$C_i = (PBC\_infi - PBC\_infi-1) - (Confi - Confi-1) + \max(0, C_{i-1})$$

$$C_1 = (200 - 0) - (250 - 100) + \max(0, 0) = 50$$

$C_1 = 50 < 0$ ? No, therefore the limiter does not apply.

Since  $C_1$  is less not less than zero, the conformance limiter does not apply. In this example because the difference in conformance between the two intervals is less than the infeasibility, the new limiter would not trigger. Said differently, the system operator's conformance between intervals 1 and 2 is less than the ramping capability on the system and therefore the limiter does not need to trigger.

Example 3:

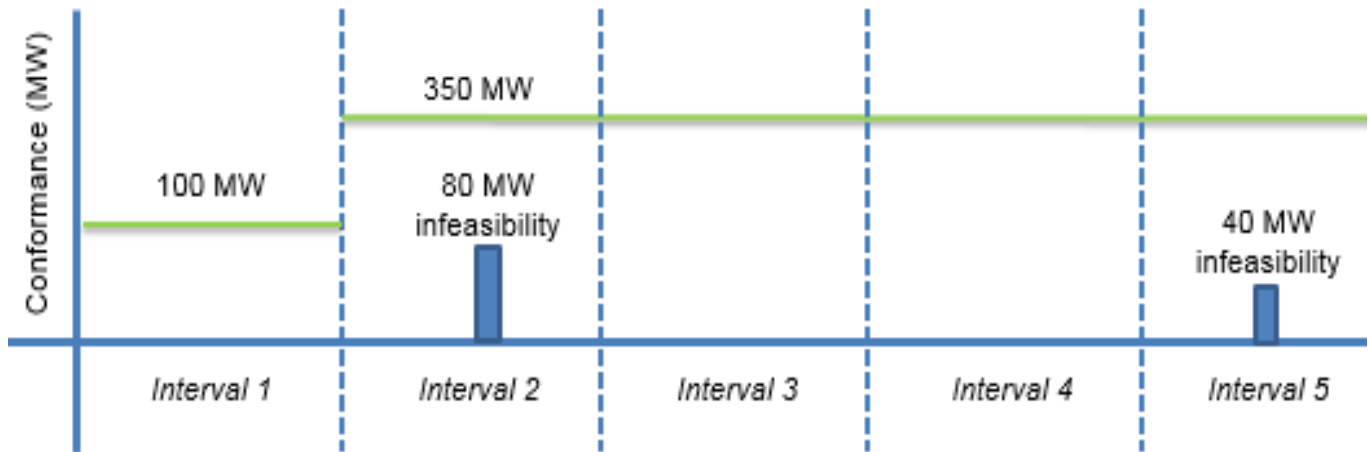

For under-generation and starting with  $C_0 = 0$ ,  $C_1$  is calculated as follows:

$$C_i = (PBC\_infi - PBC\_infi-1) - (Confi - Confi-1) + \max(0, C_{i-1})$$

$$C_1 = (80 - 0) - (350 - 100) + \max(0, 0) = -170$$

$C_1 = -170 < 0$ ? Yes, therefore the limiter applies.

There is now power balance constraint infeasibility in intervals 3 and 4 therefore setting corresponding  $C_2$  and  $C_3$  to 0.

$$C_4 = (40 - 0) - (350 - 350) + \max(0, 0) = 40$$

$C_4 = 40 < 0$ ? No, therefore the limiter does not apply.

In interval 2, the limiter triggers because the change in conformance from the previous interval is greater than the power balance constraint infeasibility. In interval 5, however, there is no change in conformance from the previous interval and therefore the limiter does not trigger because the conformance there is a carryover from the prior interval. The conformance requirement from the system operator does not change between interval 4 & 5; therefore there is adequate ramping capability in interval 5 and the limiter should not trigger.

## N. Calculation of Flexible Ramp Requirements

### Calculation of Historical Uncertainty Measurements

Uncertainty measurements are the underlying data used to form the uncertainty histograms and the uncertainty quantile regressions. Separate uncertainty measurements will be calculated for Demand, Solar, Wind, and Net Demand.

The 5min uncertainty measurements will be constructed by comparing the forecast for the first advisory RTD interval to the forecast in the same time interval for the next financially binding RTD run.

Figure 3 shows two consecutive RTD 5-minute market runs,  $RTD_1$  and  $RTD_2$ . The ISO will construct the uncertainty by subtracting the forecast from the first market run used for the first advisory interval ( $A_1$ ) from the forecast the second market run used for the binding interval ( $B_2$ ).

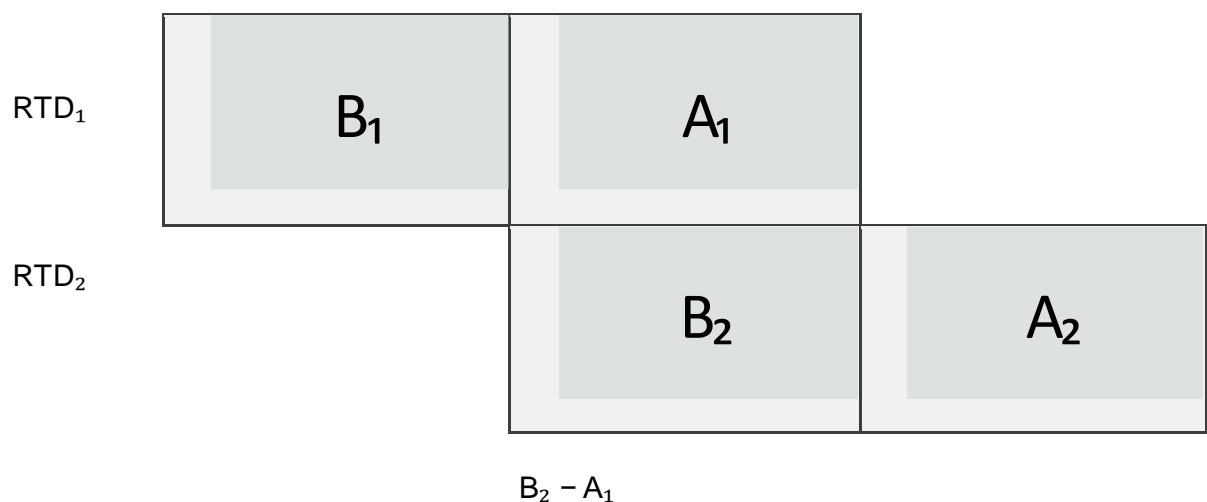

Figure 3: 5min Histogram Construction

For the 15min market (FMM), the ISO will construct uncertainty based on the following measurements.

- The difference of the forecast the market used in the FMM for the first advisory RTUC interval and the maximum forecast the market used for the three corresponding RTD intervals.
- The difference of the forecast the market used in the FMM for the first advisory RTUC interval and the minimum forecast the market used for the three corresponding RTD intervals.

Figure 4 below shows two RTUC intervals: the FMM (i.e. the RTUC binding interval) and the first advisory interval (labeled "A"). It illustrates how the maximum uncertainty measurement will be constructed by comparing the forecast the FMM used for first advisory RTUC interval to the maximum forecast the market used for the corresponding three RTD binding intervals ( $b_1, b_2, b_3$ ).



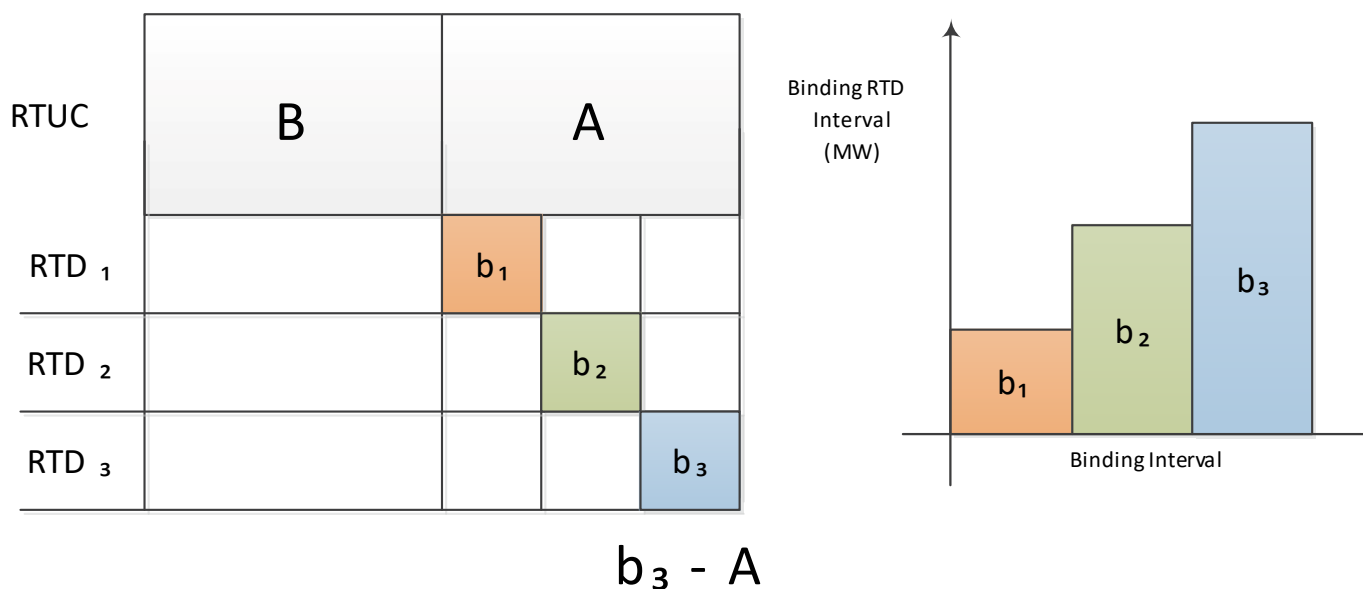

Figure 4: Histogram construction in FMM

The maximum uncertainty measurement will use the observation  $b_3 - A$ . This represents the maximum ramping need. The variable  $b_3$ , represents the maximum forecast in the three RTD intervals. The minimum uncertainty measurement will use observation  $b_1 - A$  as this is the minimum ramping need.

### Calculation of Mosaic Quantile Regression

In order to incorporate weather information into the Flexible Ramp Requirements, the ISO will use a technique called Mosaic Quantile Regression. This technique incorporates both histograms and quantile regression models to estimate uncertainty in the RTD and FMM forecasts. Quantile regressions are used to find the best quadratic relationship between the dependent variable (uncertainty) and the independent variables (demand, wind, solar, and net demand).

Below describes the components of the Mosaic Quantile Regression:

- To account for changing wind and solar penetration, historical forecast data used shall be adjusted with respect to the ratio of registered capacity for the trade date and the registered capacity for the historical date. This shall be performed prior to uncertainty calculation, histogram construction and regression. For example, if solar capacity has doubled from the historical date to the trade date, the solar forecast would likewise be doubled (indirectly impacting the concurrent solar uncertainty, net-demand forecast and net-demand uncertainty).
- Uncertainty histograms are constructed for Demand, Solar, Wind, and Net Demand separately. FRU uncertainty histograms are calculated for each trading hour and are

determined based on the 97.5th percentile. FRD uncertainty histograms are determined based on the 2.5th percentile.

- 97.5 and 2.5 Quadratic quantile regressions are constructed for each hour to estimate uncertainty separately for Demand, Solar, and Wind as a function of the forecast:

$$uncertainty_{solar} = A + B * forecast_{solar} + C * forecast_{solar}^2$$

$$uncertainty_{wind} = A + B * forecast_{wind} + C * forecast_{wind}^2$$

$$uncertainty_{demand} = A + B * forecast_{demand} + C * forecast_{demand}^2$$

- The histograms and quadratic quantile regressions are combined together into the mosaic variable to capture the complex interactions between demand, solar, and wind:

$$mosaic = NetDemand_h + (Demand_q - Demand_h) - (Wind_q - Wind_h) - (Solar_q - Solar_h)$$

- The Mosaic variable is then used as an input to the final regression. The Mosaic Quantile Regression used to estimate Net Demand uncertainty is constructed in the form of

$$uncertainty_{net\ demand} = A + B * mosaic + C * mosaic^2$$

Each hour shall have a separate Mosaic Quantile Regression. Histograms and Regression coefficients for each component shall be updated daily and determined based on respective daytype in the dataset of 180 rolling days. Daytypes are separated by weekday and weekend/holidays.

In addition to each BAA individually, regression coefficients will be calculated dynamically for the passing group. When dynamic regression is not available the coefficients will be based on the entire EIM area and may result in a higher or lower requirement.

### **Calculation of Thresholds**

Because the requirements are based on historical information, the requirements determined through this process may be representative of future forecast uncertainty and may at times also produce extreme outlier values. To ensure the CAISO does not set extreme requirements, the CAISO enforces 2 layers of thresholds to bound the FRU/FRD requirements. The first threshold is updated daily and based on the 99<sup>th</sup> percentile and 1<sup>st</sup> percentile of Net Demand uncertainty for each ~~hour based on historical data. hour and daytype in the rolling dataset of 180 days.~~ The second threshold is calculated to ensure reasonable operational requirements, and determine Max and Min values for FRU/FRD separately. The Max and Min thresholds may use 99<sup>th</sup> percentile and 1<sup>st</sup> percentile as well,

but may be based on more seasonally fit historical data. For example, the past 90 days may be a sufficient historical dataset if a drastic change is not anticipated in the coming season. The past 30 days plus the same month a year prior may be more representative if the season is changing. The CAISO will evaluate these Max and Min thresholds every quarter, or as needed with changing weather conditions. To the extent permissible, the CAISO will provide WEIM entities a week's notice prior to making any changes to the Max thresholds. Both sets of thresholds are posted publically to OASIS.

### FRU/FRD Requirement Allocation Factors

The ISO shall calculate the FRU/FRD requirement allocation factors to demand, solar, and wind for each 5 minute interval in the market horizon for each BAA that has failed the FRU/FRD sufficiency test and the group of BAAs that have passed the sufficiency test in the corresponding 15min interval as follows:

#### 5 Minute Flexible Ramp-up Allocation Factor:

$$FRUDF_5(d, s, w) \equiv \frac{|D_5^{P97.5}(d)|}{|D_5^{P97.5}(d)| + |S_5^{P2.5}(s)| + |W_5^{P2.5}(w)|}$$

$$FRUSF_5(d, s, w) \equiv \frac{|S_5^{P2.5}(s)|}{|D_5^{P97.5}(d)| + |S_5^{P2.5}(s)| + |W_5^{P2.5}(w)|}$$

$$FRUWF_5(d, s, w) \equiv \frac{|W_5^{P2.5}(w)|}{|D_5^{P97.5}(d)| + |S_5^{P2.5}(s)| + |W_5^{P2.5}(w)|}$$

#### 5 minute Flexible Ramp-down Allocation Factor:

$$FRDDF_5(d, s, w) \equiv \frac{D_5^{P2.5}(d)}{|D_5^{P2.5}(d)| + |S_5^{P97.5}(s)| + |W_5^{P97.5}(w)|}$$

$$FRDSF_5(d, s, w) \equiv \frac{|S_5^{P97.5}(s)|}{|D_5^{P2.5}(d)| + |S_5^{P97.5}(s)| + |W_5^{P97.5}(w)|}$$

$$FRDWF_5(d, s, w) \equiv \frac{|W_5^{P97.5}(w)|}{|D_5^{P2.5}(d)| + |S_5^{P97.5}(s)| + |W_5^{P97.5}(w)|}$$

#### ~~5 Minute Flexible Ramp-up Allocation Factor:~~

~~$$FRUDF_5(d, s, w) \equiv \frac{|D_5^{P97.5}(d)|}{|D_5^{P97.5}(d)| + |S_5^{P2.5}(s)| + |W_5^{P2.5}(w)|}$$~~

$$FRUSF_5(d, s, w) = \frac{|S_5^{P2.5}(s)|}{|D_5^{P97.5}(d)| + |S_5^{P2.5}(s)| + |W_5^{P2.5}(w)|}$$

$$FRUWF_5(d, s, w) = \frac{|W_5^{P2.5}(w)|}{|D_5^{P97.5}(d)| + |S_5^{P2.5}(s)| + |W_5^{P2.5}(w)|}$$

**5 minute Flexible Ramp-down Allocation Factor:**

$$FRDDF_5(d, s, w) = \frac{D_5^{P2.5}(d)}{|D_5^{P2.5}(d)| + |S_5^{P97.5}(s)| + |W_5^{P97.5}(w)|}$$

$$FRDSF_5(d, s, w) = \frac{|S_5^{P97.5}(s)|}{|D_5^{P2.5}(d)| + |S_5^{P97.5}(s)| + |W_5^{P97.5}(w)|}$$

$$FRDWF_5(d, s, w) = \frac{|W_5^{P97.5}(w)|}{|D_5^{P2.5}(d)| + |S_5^{P97.5}(s)| + |W_5^{P97.5}(w)|}$$

The ISO shall calculate the FRU/FRD requirement allocation factors to demand, solar, and wind for each 15 minute interval in the market horizon for each BAA that has failed either the FRU or FRD sufficiency test and the group of BAA that have passed the sufficiency test as follows:

**15 minute Flexible Ramp-up Allocation Factor:**

$$FRUDF_{15}(d, s, w) = \frac{|D_{15}^{P97.5}(d)|}{|D_{15}^{P97.5}(d)| + |S_{15}^{P2.5}(s)| + |W_{15}^{P2.5}(w)|}$$

$$FRUSF_{15}(d, s, w) = \frac{|S_{15}^{P2.5}(s)|}{|D_{15}^{P97.5}(d)| + |S_{15}^{P2.5}(s)| + |W_{15}^{P2.5}(w)|}$$

$$FRUWF_{15}(d, s, w) = \frac{|W_{15}^{P2.5}(w)|}{|D_{15}^{P97.5}(d)| + |S_{15}^{P2.5}(s)| + |W_{15}^{P2.5}(w)|}$$

**15 minute Flexible Ramp-down Allocation Factor:**

$$FRDDF_{15}(d, s, w) = \frac{|D_{15}^{P2.5}(d)|}{|D_{15}^{P2.5}(d)| + |S_{15}^{P97.5}(s)| + |W_{15}^{P97.5}(w)|}$$

$$FRDSF_{15}(d, s, w) = \frac{|S_{15}^{P97.5}(s)|}{|D_{15}^{P2.5}(d)| + |S_{15}^{P97.5}(s)| + |W_{15}^{P97.5}(w)|}$$

$$FRDWF_{15}(d, s, w) = \frac{|W_{15}^{P97.5}(w)|}{|D_{15}^{P2.5}(d)| + |S_{15}^{P97.5}(s)| + |W_{15}^{P97.5}(w)|}$$

**45 minute Flexible Ramp-up Allocation Factor:**

$$\cancel{FRUDF_{15}(d,s,w)} = \frac{|D_{15}^{P97.5}(d)|}{|D_{15}^{P97.5}(d)| + |S_{15}^{P2.5}(s)| + |W_{15}^{P2.5}(w)|}$$

$$\cancel{FRUSF_{15}(d,s,w)} = \frac{|S_{15}^{P2.5}(s)|}{|D_{15}^{P97.5}(d)| + |S_{15}^{P2.5}(s)| + |W_{15}^{P2.5}(w)|}$$

$$\cancel{FRUWF_{15}(d,s,w)} = \frac{|W_{15}^{P2.5}(w)|}{|D_{15}^{P97.5}(d)| + |S_{15}^{P2.5}(s)| + |W_{15}^{P2.5}(w)|}$$

~~15 minute Flexible Ramp-down Allocation Factor:~~

$$\cancel{FRDDF_{15}(d,s,w)} = \frac{|D_{15}^{P2.5}(d)|}{|D_{15}^{P2.5}(d)| + |S_{15}^{P97.5}(s)| + |W_{15}^{P97.5}(w)|}$$

$$\cancel{FRDSF_{15}(d,s,w)} = \frac{|S_{15}^{P97.5}(s)|}{|D_{15}^{P2.5}(d)| + |S_{15}^{P97.5}(s)| + |W_{15}^{P97.5}(w)|}$$

$$\cancel{FRDWF_{15}(d,s,w)} = \frac{|W_{15}^{P97.5}(w)|}{|D_{15}^{P2.5}(d)| + |S_{15}^{P97.5}(s)| + |W_{15}^{P97.5}(w)|}$$

The ISO will calculate the FRU/FRD requirement allocation factors to demand, solar, and wind for each 15 minute interval in the first two hours and last 3 hours of the market horizon for each BAA that has failed the FRU/FRD sufficiency test and for the group of BAAs that have passed the FRU/FRD sufficiency test.

The ISO will distribute the FRU/FRD requirement allocated to demand in each interval of the market horizon in the FRU/FRD deployment scenario as positive load to the load nodes in the respective BAA or BAA group with the same distribution factors used for distributing the demand forecast.

The ISO will distribute the FRU/FRD requirement allocated to solar in each interval of the market horizon in the FRU/FRD deployment scenario as positive load to the solar VER nodes in the respective BAA or BAA group pro rata on the respective solar VER forecast.

The ISO will distribute the FRU/FRD requirement allocated to wind in each interval of the market horizon in the FRU/FRD deployment scenario as positive load to the wind VER nodes in the respective BAA or BAA group pro rata on the respective wind VER forecast.

The ISO shall distribute the FRU surplus in each interval of the market horizon in the FRU deployment scenario as negative load to the load and VER nodes in the respective FRP Surplus Zone with the same distribution factors used for distributing the FRU requirement in that zone. The total FRU surplus in each BAA in the EIM Area shall be limited to the distributed FRU requirement in that BAA.

The ISO shall distribute the FRD surplus in each interval of the market horizon in the FRD deployment scenario as positive load to the load and VER nodes in the respective FRP Surplus Zone with the same distribution factors used for distributing the FRD requirement in

that zone. The total FRD surplus in each BAA in the EIM Area shall be limited to the distributed FRD requirement in that BAA.

The ISO shall calculate the FRU demand price curve  $\{Q_k, P_k, k = 1, 2, \dots, n\}$   ~~$\{Q_k, P_k, k = 1, 2, \dots, n\}$~~  for each interval of the market horizon for each BAA in the EIM Area.

Note: The FRU demand price curve has increasing positive quantities (in an ascending order on the quantities to ensure the MW quantities monotonically increasing) and decreasing positive prices:

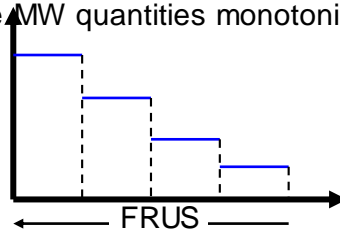

The ISO shall extend or prune the end of the FRU demand price curve for each BAA in the EIM Area to match the corresponding FRU requirement distributed to that BAA. The ISO shall allocate the FRU surplus price curve for each interval of the market horizon for each BAA in the EIM Area to the FRP Surplus Zones of that BAA in proportion to the distributed FRU requirement in that zone. The ISO shall enforce transmission constraints for the base case and critical contingencies for the FRU deployment scenario.

The ISO shall calculate the FRD demand price curve  $\{Q_k, P_k, k = 1, 2, \dots, n\}$   ~~$\{Q_k, P_k, k = 1, 2, \dots, n\}$~~  for each interval of the market horizon for each BAA in the EIM Area.

Note: The FRD demand price curve has decreasing negative quantities (in a descending order on the quantities to ensure the MW quantities monotonically decreasing) and decreasing positive prices:

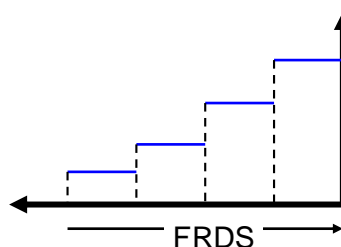

---

The ISO shall prune the end of the FRD demand price curve for each BAA in the EIM Area to match the corresponding FRD requirement distributed to that BAA. The ISO shall allocate the FRD surplus price curve for each interval of the market horizon for each BAA in the EIM Area to the FRP Surplus Zones of that BAA in proportion to the distributed FRD requirement in that zone. The ISO shall enforce transmission constraints for the base case and critical contingencies for the FRD deployment scenario.

The ISO shall extend the current DCPA and LMPM method to binding transmission constraints in the FRU/FRD deployment scenario. In DCPA, the supply counter flow shall be the energy schedules plus the FRU awards or minus the FRD awards.

The ISO shall limit from below (in the import direction) the algebraic net transfer (positive for export and negative for import) of each BAA that has failed the FRU sufficiency test in each interval of the market horizon to the less restrictive of the base net transfer for that BAA and interval or the net transfer of the interval prior to the failed interval. The ISO shall constrain the net transfer in the FRU deployment scenario of each BAA that has failed the FRU sufficiency test in each interval of the market horizon to the net transfer in the base scenario of meeting the demand forecast for that BAA and interval. However, the individual dynamic (and static in RTUC/STUC) transfers (ETSRs) shall be allowed to move in the FRU deployment scenario between zero and their respective scheduling limit.

The ISO shall constrain the net transfer in the FRU deployment scenario of each BAA that has passed the FRU sufficiency test in each interval of the market horizon to the net transfer in the base scenario of meeting the demand forecast for that BAA and interval, plus the sum of all FRU awards in that BAA and interval, plus the total FRU surplus in that BAA and interval, minus the distributed FRU requirement in that BAA and interval. However, the individual dynamic (and static in RTUC/STUC) transfers (ETSRs) shall be allowed to move in the FRU deployment scenario between zero and their respective scheduling limit.

The ISO shall limit from above (in the export direction) the algebraic net transfer (positive for export and negative for import) of each BAA that has failed the FRD sufficiency test in each interval of the market horizon to the less restrictive of the base net transfer for that BAA and interval or the net transfer of the interval prior to the failed interval. The ISO shall constrain the net transfer in the FRD deployment scenario of each BAA that has failed the FRD sufficiency test in each interval of the market horizon to the net transfer in the base scenario of meeting the demand forecast for that BAA and interval. However, the individual dynamic (and static in RTUC/STUC) transfers (ETSRs) shall be allowed to move in the FRD deployment scenario between zero and their respective scheduling limit.

The ISO shall constrain the net transfer in the FRD deployment scenario of each BAA that has passed the FRD sufficiency test in each interval of the market horizon to the net transfer in the base scenario of meeting the demand forecast for that BAA and interval, minus the sum of all FRD awards in that BAA and interval, minus the total FRD surplus in that BAA and interval plus the distributed FRD requirement in that BAA and interval. However, the individual dynamic (and static in RTUC/STUC) transfers (ETSRs) shall be allowed to move in the FRD deployment scenario between zero and their respective scheduling limit.